



City Environmental Quality Review

ENVIRONMENTAL ASSESSMENT STATEMENT (EAS) SHORT FORM

FOR UNLISTED ACTIONS ONLY • Please fill out and submit to the appropriate agency ([see instructions](#))

Part I: GENERAL INFORMATION

1. Does the Action Exceed Any Type I Threshold in 6 NYCRR Part 617.4 or 43 RCNY §6-15(A) (Executive Order 91 of 1977, as amended)? YES NO

If "yes," STOP and complete the [FULL EAS FORM](#).

2. Project Name Blondell Commons

3. Reference Numbers

CEQR REFERENCE NUMBER (to be assigned by lead agency)
17DCP194X

BSA REFERENCE NUMBER (if applicable)

ULURP REFERENCE NUMBER (if applicable)
170353MMX, 170439ZRX, 170438ZMX

OTHER REFERENCE NUMBER(S) (if applicable)
(e.g., legislative intro, CAPA) P2012X0046

4a. Lead Agency Information

NAME OF LEAD AGENCY
NYC Department of City Planning

4b. Applicant Information

NAME OF APPLICANT
HP MJM Housing Development Fund Company, Inc.,
Blondell Equities LLC

NAME OF LEAD AGENCY CONTACT PERSON
Olga Abinader

NAME OF APPLICANT'S REPRESENTATIVE OR CONTACT PERSON
John Strauss for Hiram A. Rothkrug, Environmental
Studies Corp.

ADDRESS 120 Broadway, 31st Floor

ADDRESS 55 Water Mill Road

CITY New York

STATE NY

ZIP 10271

CITY Great Neck

STATE NY

ZIP 11021

TELEPHONE 212-720-3493

EMAIL
oabinad@planning.nyc.gov

TELEPHONE 718-343-
0026

EMAIL
jstrauss@environmentalstud
iescorp.com

5. Project Description

The Applicant, HP MJM Housing Development Fund Company, Inc. as legal owner and Blondell Equities LLC, as beneficial owner, is proposing the following Proposed Actions:

- A Zoning Map Amendment from an existing M1-1 district to an R7A/C2-4 district of properties bounded by Blondell Avenue, Ponton Avenue, Westchester Avenue, and the NYC Transit Yard in the Westchester Square neighborhood of the Bronx, Community District 11. This would involve a rezoning of the Applicant's property, Block 4134, Lot 1 (formerly Block 4134, Lots 1, 2, 4, 62, 63, and 70 and Block 4133, Lot 12), and non-Applicant properties, identified as Block 4133, Lots 1, 2, 8 (partial as the Fink Avenue portion of this lot is not zoned and is to be demapped in association with a change to the City Map), 10, 61, 62, and 63 (partial as a portion of this lot is located outside of the rezoning area boundary) plus 50% of the to be demapped portion of Ponton Avenue (Block 4134, Lot 14-partial) adjacent to the rezoning area.
- A Zoning Text Amendment to modify ZR §23-933, Appendix F to designate the newly mapped R7A/C2-4 district as a Mandatory Inclusionary Housing designated area.
- A demapping of Fink Avenue between Blondell and Waters Avenues.

The proposed project on Projected Development Site 1 is the development of a new nine-story and cellar, 95'-0" tall mixed-use building totaling 261,660 gross square feet (gsf) [including cellar area] and containing 228 dwelling units within 198,683 gsf on floors 1-9 (plus 7,558 gsf of cellar space). 227 of the 228 units would be considered affordable with 65% or 148 units at 80% of Area Median Income (AMI) or less and 35% or 79 units at 100% AMI or less as approved by HPD. One dwelling unit would be provided for the building superintendent and is not included in the affordability breakdown above. The development would also contain 19,668 gsf of retail space and 2,024 gsf of community facility space. The development would include 225 attended accessory parking spaces.

The remainder of the Proposed Rezoning Area, Block 4133, Lots 1, 2, 8 (partial), 10, 61, 62, and 63 (partial) plus 50% of the to be demapped portion of Ponton Avenue (Block 4134, Lot 14-partial) adjacent to the rezoning area, is not proposed for development and is not controlled by the Applicant. However, it is anticipated that new development

would occur on five Projected Development Sites as follows.

Projected Development Site 2 (Block 4133, Lot 1) would be developed with a 9-story, 95'-0" tall, 13,616 gsf mixed use building containing 11,686 gsf of residential floor area for 13 dwelling units, 3 of which would be affordable at 80% AMI. The development would also include 1,930 gsf of ground floor commercial space. Parking would be waived.

Projected Development Site 3 (Block 4133, Lot 2) would be developed with a 9-story, 95'-0" tall, 64,552 gsf mixed use building containing 42,745 gsf of residential floor area for 49 dwelling units, 10 of which would be affordable at 80% AMI. The development would also include 10,557 gsf of ground floor commercial space and 11,250 gsf for cellar level parking. 19 cellar level parking spaces would be provided on the Site.

Projected Development Site 4 (Block 4133, Lot 63 [p/o]) would be developed with a 9-story, 95'-0" tall, 66,922 gsf mixed use building containing 45,989 gsf of residential floor area for 53 dwelling units, 11 of which would be affordable at 80% AMI. The development would also include 9,270 gsf of ground floor commercial space and 11,663 gsf for cellar level parking. 21 cellar level parking spaces would be provided on the Site.

Projected Development Site 5 (Block 4133, Lot 10) would be developed with a 9-story, 95'-0" tall, 23,453 gsf mixed use building containing 19,385 gsf of residential floor area for 22 dwelling units, 5 of which would be affordable at 80% AMI. The development would also include 4,068 gsf of ground floor commercial space. Parking would be waived.

Projected Development Site 6 (Block 4133, Lots 61 & 62) would be developed with a 9-story, 95'-0" tall, 19,625 gsf mixed use building containing 16,389 gsf of residential floor area for 19 dwelling units, 4 of which would be affordable at 80% AMI. The development would also include 3,236 gsf of ground floor commercial space. Parking would be waived.

See attached Project Description.

Project Location

BOROUGH Bronx	COMMUNITY DISTRICT(S) 11	STREET ADDRESS 1340 Blondell Avenue
TAX BLOCK(S) AND LOT(S) Block 4134, Lots 1, 14 (partial); Block 4133, Lots 1, 2, 8 (partial), 10, 12, 61, 62, and 63 (partial)		ZIP CODE 10461
DESCRIPTION OF PROPERTY BY BOUNDING OR CROSS STREETS Area bounded by Blondell Avenue, Ponton Avenue, Westchester Avenue, and the NYC Transit Yard		
EXISTING ZONING DISTRICT, INCLUDING SPECIAL ZONING DISTRICT DESIGNATION, IF ANY M1-1		ZONING SECTIONAL MAP NUMBER 4b

6. Required Actions or Approvals (check all that apply)

City Planning Commission: YES NO UNIFORM LAND USE REVIEW PROCEDURE (ULURP)

<input checked="" type="checkbox"/> CITY MAP AMENDMENT	<input type="checkbox"/> ZONING CERTIFICATION	<input type="checkbox"/> CONCESSION
<input checked="" type="checkbox"/> ZONING MAP AMENDMENT	<input type="checkbox"/> ZONING AUTHORIZATION	<input type="checkbox"/> UDAAP
<input checked="" type="checkbox"/> ZONING TEXT AMENDMENT	<input type="checkbox"/> ACQUISITION—REAL PROPERTY	<input type="checkbox"/> REVOCABLE CONSENT
<input type="checkbox"/> SITE SELECTION—PUBLIC FACILITY	<input type="checkbox"/> DISPOSITION—REAL PROPERTY	<input type="checkbox"/> FRANCHISE
<input type="checkbox"/> HOUSING PLAN & PROJECT	<input type="checkbox"/> OTHER, explain:	
<input type="checkbox"/> SPECIAL PERMIT (if appropriate, specify type: <input type="checkbox"/> modification; <input type="checkbox"/> renewal; <input checked="" type="checkbox"/> other); EXPIRATION DATE:		

SPECIFY AFFECTED SECTIONS OF THE ZONING RESOLUTION 23-933, Appendix F

Board of Standards and Appeals: YES NO

VARIANCE (use)

VARIANCE (bulk)

SPECIAL PERMIT (if appropriate, specify type: modification; renewal; other); EXPIRATION DATE:

SPECIFY AFFECTED SECTIONS OF THE ZONING RESOLUTION

Department of Environmental Protection: YES NO If "yes," specify:

Other City Approvals Subject to CEQR (check all that apply)

LEGISLATION FUNDING OF CONSTRUCTION, specify: HPD Mixed Middle Income Program*

*A previous version of the EAS erroneously noted the HPD ELLA Program for construction funding. The correct funding source is the HPD Mixed Middle Income Program, noted above.

<input type="checkbox"/> RULEMAKING	<input type="checkbox"/> POLICY OR PLAN, specify:
<input type="checkbox"/> CONSTRUCTION OF PUBLIC FACILITIES	<input type="checkbox"/> FUNDING OF PROGRAMS, specify:
<input type="checkbox"/> 384(b)(4) APPROVAL	<input type="checkbox"/> PERMITS, specify:
<input type="checkbox"/> OTHER, explain:	

Other City Approvals Not Subject to CEQR (check all that apply)

<input type="checkbox"/> PERMITS FROM DOT'S OFFICE OF CONSTRUCTION MITIGATION AND COORDINATION (OCMC)	<input type="checkbox"/> LANDMARKS PRESERVATION COMMISSION APPROVAL
	<input checked="" type="checkbox"/> OTHER, explain: Dept. of Buildings building permit

State or Federal Actions/Approvals/Funding: YES NO If "yes," specify:

7. Site Description: The directly affected area consists of the project site and the area subject to any change in regulatory controls. Except where otherwise indicated, provide the following information with regard to the directly affected area.

Graphics: The following graphics must be attached and each box must be checked off before the EAS is complete. Each map must clearly depict the boundaries of the directly affected area or areas and indicate a 400-foot radius drawn from the outer boundaries of the project site. Maps may not exceed 11 x 17 inches in size and, for paper filings, must be folded to 8.5 x 11 inches.

<input checked="" type="checkbox"/> SITE LOCATION MAP	<input checked="" type="checkbox"/> ZONING MAP	<input checked="" type="checkbox"/> SANBORN OR OTHER LAND USE MAP
<input checked="" type="checkbox"/> TAX MAP	<input type="checkbox"/> FOR LARGE AREAS OR MULTIPLE SITES, A GIS SHAPE FILE THAT DEFINES THE PROJECT SITE(S)	
<input checked="" type="checkbox"/> PHOTOGRAPHS OF THE PROJECT SITE TAKEN WITHIN 6 MONTHS OF EAS SUBMISSION AND KEYED TO THE SITE LOCATION MAP		

Physical Setting (both developed and undeveloped areas)

Total directly affected area (sq. ft.): 106,968 (Rezoning Area); 46,360 (Proposed Development Site) Waterbody area (sq. ft) and type: 0

Roads, buildings, and other paved surfaces (sq. ft.): 106,968 (Rezoning Area); 46,360 (Proposed Development Site) Other, describe (sq. ft.): 0

8. Physical Dimensions and Scale of Project (if the project affects multiple sites, provide the total development facilitated by the action)

SIZE OF PROJECT TO BE DEVELOPED (gross square feet): 261,660

NUMBER OF BUILDINGS: 1 GROSS FLOOR AREA OF EACH BUILDING (sq. ft.): 261,660

HEIGHT OF EACH BUILDING (ft.): 95' NUMBER OF STORIES OF EACH BUILDING: 9

Does the proposed project involve changes in zoning on one or more sites? YES NO

If "yes," specify: The total square feet owned or controlled by the applicant: 46,380

The total square feet not owned or controlled by the applicant: 60,608

Does the proposed project involve in-ground excavation or subsurface disturbance, including, but not limited to foundation work, pilings, utility lines, or grading? YES NO

If "yes," indicate the estimated area and volume dimensions of subsurface permanent and temporary disturbance (if known):

AREA OF TEMPORARY DISTURBANCE: sq. ft. (width x length) VOLUME OF DISTURBANCE: 417,420 cubic ft. (width x length x depth)

AREA OF PERMANENT DISTURBANCE: 46,360 sq. ft. (width x length)

Description of Proposed Uses (please complete the following information as appropriate)

	Residential	Commercial	Community Facility	Industrial/Manufacturing
Size (in gross sq. ft.)	206,241	19,668	2,024	0
Type (e.g., retail, office, school)	228 units	retail	medical offices	0

Does the proposed project increase the population of residents and/or on-site workers? YES NO

If "yes," please specify: NUMBER OF ADDITIONAL RESIDENTS: 654 NUMBER OF ADDITIONAL WORKERS: 76

Provide a brief explanation of how these numbers were determined: Residents: Based on average household size of 2.87 residents per dwelling unit (2010 Census) in Census Tracts within 1/4 mile (tracts 96, 194, 200, 202, 264, and 284); Workers: assumes 3 workers per 1,000 gsf retail, 4 workers per 1,000 gsf medical offices, .04 workers per dwelling unit

Does the proposed project create new open space? YES NO If "yes," specify size of project-created open space: sq. ft.

Has a No-Action scenario been defined for this project that differs from the existing condition? YES NO

If "yes," see [Chapter 2](#), "Establishing the Analysis Framework" and describe briefly:

9. Analysis Year [CEQR Technical Manual Chapter 2](#)

ANTICIPATED BUILD YEAR (date the project would be completed and operational): 2029

ANTICIPATED PERIOD OF CONSTRUCTION IN MONTHS: 24

WOULD THE PROJECT BE IMPLEMENTED IN A SINGLE PHASE? YES NO IF MULTIPLE PHASES, HOW MANY?

BRIEFLY DESCRIBE PHASES AND CONSTRUCTION SCHEDULE:

10. Predominant Land Use in the Vicinity of the Project (check all that apply)

- RESIDENTIAL MANUFACTURING COMMERCIAL PARK/FOREST/OPEN SPACE OTHER, specify:
community facility,
transportation related, vacant

Part II: TECHNICAL ANALYSIS

INSTRUCTIONS: For each of the analysis categories listed in this section, assess the proposed project’s impacts based on the thresholds and criteria presented in the CEQR Technical Manual. Check each box that applies.

- If the proposed project can be demonstrated not to meet or exceed the threshold, check the “no” box.
- If the proposed project will meet or exceed the threshold, or if this cannot be determined, check the “yes” box.
- For each “yes” response, provide additional analyses (and, if needed, attach supporting information) based on guidance in the CEQR Technical Manual to determine whether the potential for significant impacts exists. Please note that a “yes” answer does not mean that an EIS must be prepared—it means that more information may be required for the lead agency to make a determination of significance.
- The lead agency, upon reviewing Part II, may require an applicant to provide additional information to support the Short EAS Form. For example, if a question is answered “no,” an agency may request a short explanation for this response.

	YES	NO
1. LAND USE, ZONING, AND PUBLIC POLICY: CEQR Technical Manual Chapter 4		
(a) Would the proposed project result in a change in land use different from surrounding land uses?	<input checked="" type="checkbox"/>	<input type="checkbox"/>
(b) Would the proposed project result in a change in zoning different from surrounding zoning?	<input checked="" type="checkbox"/>	<input type="checkbox"/>
(c) Is there the potential to affect an applicable public policy?	<input checked="" type="checkbox"/>	<input type="checkbox"/>
(d) If “yes,” to (a), (b), and/or (c), complete a preliminary assessment and attach.		
(e) Is the project a large, publicly sponsored project?	<input type="checkbox"/>	<input checked="" type="checkbox"/>
o If “yes,” complete a PlaNYC assessment and attach.		
(f) Is any part of the directly affected area within the City’s Waterfront Revitalization Program boundaries ?	<input checked="" type="checkbox"/>	<input type="checkbox"/>
o If “yes,” complete the Consistency Assessment Form . See attached report.		
2. SOCIOECONOMIC CONDITIONS: CEQR Technical Manual Chapter 5		
(a) Would the proposed project:		
o Generate a net increase of 200 or more residential units?	<input checked="" type="checkbox"/>	<input type="checkbox"/>
o Generate a net increase of 200,000 or more square feet of commercial space?	<input type="checkbox"/>	<input checked="" type="checkbox"/>
o Directly displace more than 500 residents?	<input type="checkbox"/>	<input checked="" type="checkbox"/>
o Directly displace more than 100 employees?	<input type="checkbox"/>	<input checked="" type="checkbox"/>
o Affect conditions in a specific industry?	<input type="checkbox"/>	<input checked="" type="checkbox"/>
3. COMMUNITY FACILITIES: CEQR Technical Manual Chapter 6		
(a) Direct Effects		
o Would the project directly eliminate, displace, or alter public or publicly funded community facilities such as educational facilities, libraries, hospitals and other health care facilities, day care centers, police stations, or fire stations?	<input type="checkbox"/>	<input checked="" type="checkbox"/>
(b) Indirect Effects		
o Child Care Centers: Would the project result in 20 or more eligible children under age 6, based on the number of low or low/moderate income residential units? (See Table 6-1 in Chapter 6)	<input checked="" type="checkbox"/>	<input type="checkbox"/>
o Libraries: Would the project result in a 5 percent or more increase in the ratio of residential units to library branches? (See Table 6-1 in Chapter 6)	<input type="checkbox"/>	<input checked="" type="checkbox"/>
o Public Schools: Would the project result in 50 or more elementary or middle school students, or 150 or more high school students based on number of residential units? (See Table 6-1 in Chapter 6)	<input checked="" type="checkbox"/>	<input type="checkbox"/>
o Health Care Facilities and Fire/Police Protection: Would the project result in the introduction of a sizeable new neighborhood?	<input type="checkbox"/>	<input checked="" type="checkbox"/>
4. OPEN SPACE: CEQR Technical Manual Chapter 7		
(a) Would the proposed project change or eliminate existing open space?	<input type="checkbox"/>	<input checked="" type="checkbox"/>
(b) Is the project located within an under-served area in the Bronx , Brooklyn , Manhattan , Queens , or Staten Island ?	<input type="checkbox"/>	<input checked="" type="checkbox"/>
o If “yes,” would the proposed project generate more than 50 additional residents or 125 additional employees?	<input type="checkbox"/>	<input type="checkbox"/>
(c) Is the project located within a well-served area in the Bronx , Brooklyn , Manhattan , Queens , or Staten Island ?	<input type="checkbox"/>	<input checked="" type="checkbox"/>
o If “yes,” would the proposed project generate more than 350 additional residents or 750 additional employees?	<input type="checkbox"/>	<input type="checkbox"/>
(d) If the project is located in an area that is neither under-served nor well-served, would it generate more than 200 additional residents or 500 additional employees?	<input checked="" type="checkbox"/>	<input type="checkbox"/>

	YES	NO
5. SHADOWS: CEQR Technical Manual Chapter 8		
(a) Would the proposed project result in a net height increase of any structure of 50 feet or more?	<input checked="" type="checkbox"/>	<input type="checkbox"/>
(b) Would the proposed project result in any increase in structure height and be located adjacent to or across the street from a sunlight-sensitive resource?	<input type="checkbox"/>	<input checked="" type="checkbox"/>
6. HISTORIC AND CULTURAL RESOURCES: CEQR Technical Manual Chapter 9		
(a) Does the proposed project site or an adjacent site contain any architectural and/or archaeological resource that is eligible for or has been designated (or is calendared for consideration) as a New York City Landmark, Interior Landmark or Scenic Landmark; that is listed or eligible for listing on the New York State or National Register of Historic Places; or that is within a designated or eligible New York City, New York State or National Register Historic District? (See the GIS System for Archaeology and National Register to confirm)	<input type="checkbox"/>	<input checked="" type="checkbox"/>
(b) Would the proposed project involve construction resulting in in-ground disturbance to an area not previously excavated?	<input checked="" type="checkbox"/>	<input type="checkbox"/>
(c) If "yes" to either of the above, list any identified architectural and/or archaeological resources and attach supporting information on whether the proposed project would potentially affect any architectural or archeological resources. See attached report.		
7. URBAN DESIGN AND VISUAL RESOURCES: CEQR Technical Manual Chapter 10		
(a) Would the proposed project introduce a new building, a new building height, or result in any substantial physical alteration to the streetscape or public space in the vicinity of the proposed project that is not currently allowed by existing zoning?	<input checked="" type="checkbox"/>	<input type="checkbox"/>
(b) Would the proposed project result in obstruction of publicly accessible views to visual resources not currently allowed by existing zoning?	<input type="checkbox"/>	<input checked="" type="checkbox"/>
8. NATURAL RESOURCES: CEQR Technical Manual Chapter 11		
(a) Does the proposed project site or a site adjacent to the project contain natural resources as defined in Section 100 of Chapter 11 ?	<input type="checkbox"/>	<input checked="" type="checkbox"/>
o If "yes," list the resources and attach supporting information on whether the proposed project would affect any of these resources.		
(b) Is any part of the directly affected area within the Jamaica Bay Watershed ?	<input type="checkbox"/>	<input checked="" type="checkbox"/>
o If "yes," complete the Jamaica Bay Watershed Form , and submit according to its instructions .		
9. HAZARDOUS MATERIALS: CEQR Technical Manual Chapter 12		
(a) Would the proposed project allow commercial or residential uses in an area that is currently, or was historically, a manufacturing area that involved hazardous materials?	<input checked="" type="checkbox"/>	<input type="checkbox"/>
(b) Does the proposed project site have existing institutional controls (e.g., (E) designation or Restrictive Declaration) relating to hazardous materials that preclude the potential for significant adverse impacts?	<input type="checkbox"/>	<input checked="" type="checkbox"/>
(c) Would the project require soil disturbance in a manufacturing area or any development on or near a manufacturing area or existing/historic facilities listed in Appendix 1 (including nonconforming uses)?	<input checked="" type="checkbox"/>	<input type="checkbox"/>
(d) Would the project result in the development of a site where there is reason to suspect the presence of hazardous materials, contamination, illegal dumping or fill, or fill material of unknown origin?	<input checked="" type="checkbox"/>	<input type="checkbox"/>
(e) Would the project result in development on or near a site that has or had underground and/or aboveground storage tanks (e.g., gas stations, oil storage facilities, heating oil storage)?	<input checked="" type="checkbox"/>	<input type="checkbox"/>
(f) Would the project result in renovation of interior existing space on a site with the potential for compromised air quality; vapor intrusion from either on-site or off-site sources; or the presence of asbestos, PCBs, mercury or lead-based paint?	<input type="checkbox"/>	<input checked="" type="checkbox"/>
(g) Would the project result in development on or near a site with potential hazardous materials issues such as government-listed voluntary cleanup/brownfield site, current or former power generation/transmission facilities, coal gasification or gas storage sites, railroad tracks or rights-of-way, or municipal incinerators?	<input checked="" type="checkbox"/>	<input type="checkbox"/>
(h) Has a Phase I Environmental Site Assessment been performed for the site?	<input checked="" type="checkbox"/>	<input type="checkbox"/>
o If "yes," were Recognized Environmental Conditions (RECs) identified? Briefly identify: See attached report.	<input checked="" type="checkbox"/>	<input type="checkbox"/>
10. WATER AND SEWER INFRASTRUCTURE: CEQR Technical Manual Chapter 13		
(a) Would the project result in water demand of more than one million gallons per day?	<input type="checkbox"/>	<input checked="" type="checkbox"/>
(b) If the proposed project located in a combined sewer area, would it result in at least 1,000 residential units or 250,000 square feet or more of commercial space in Manhattan, or at least 400 residential units or 150,000 square feet or more of commercial space in the Bronx, Brooklyn, Staten Island, or Queens?	<input type="checkbox"/>	<input checked="" type="checkbox"/>
(c) If the proposed project located in a separately sewered area , would it result in the same or greater development than the amounts listed in Table 13-1 in Chapter 13 ?	<input type="checkbox"/>	<input checked="" type="checkbox"/>
(d) Would the proposed project involve development on a site that is 5 acres or larger where the amount of impervious surface would increase?	<input type="checkbox"/>	<input checked="" type="checkbox"/>
(e) If the project is located within the Jamaica Bay Watershed or in certain specific drainage areas , including Bronx River, Coney Island Creek, Flushing Bay and Creek, Gowanus Canal, Hutchinson River, Newtown Creek, or Westchester Creek, would it involve development on a site that is 1 acre or larger where the amount of impervious surface would increase?	<input type="checkbox"/>	<input checked="" type="checkbox"/>

	YES	NO
(f) Would the proposed project be located in an area that is partially sewerred or currently unsewerred?	<input type="checkbox"/>	<input checked="" type="checkbox"/>
(g) Is the project proposing an industrial facility or activity that would contribute industrial discharges to a Wastewater Treatment Plant and/or generate contaminated stormwater in a separate storm sewer system?	<input type="checkbox"/>	<input checked="" type="checkbox"/>
(h) Would the project involve construction of a new stormwater outfall that requires federal and/or state permits?	<input type="checkbox"/>	<input checked="" type="checkbox"/>
11. SOLID WASTE AND SANITATION SERVICES: CEQR Technical Manual Chapter 14		
(a) Using Table 14-1 in Chapter 14 , the project's projected operational solid waste generation is estimated to be (pounds per week): 14,081		
o Would the proposed project have the potential to generate 100,000 pounds (50 tons) or more of solid waste per week?	<input type="checkbox"/>	<input checked="" type="checkbox"/>
(b) Would the proposed project involve a reduction in capacity at a solid waste management facility used for refuse or recyclables generated within the City?	<input type="checkbox"/>	<input checked="" type="checkbox"/>
12. ENERGY: CEQR Technical Manual Chapter 15		
(a) Using energy modeling or Table 15-1 in Chapter 15 , the project's projected energy use is estimated to be (annual BTUs): 30,882,714		
(b) Would the proposed project affect the transmission or generation of energy?	<input type="checkbox"/>	<input checked="" type="checkbox"/>
13. TRANSPORTATION: CEQR Technical Manual Chapter 16		
(a) Would the proposed project exceed any threshold identified in Table 16-1 in Chapter 16 ?	<input checked="" type="checkbox"/>	<input type="checkbox"/>
(b) If "yes," conduct the screening analyses, attach appropriate back up data as needed for each stage and answer the following questions:		
o Would the proposed project result in 50 or more Passenger Car Equivalents (PCEs) per project peak hour?	<input checked="" type="checkbox"/>	<input type="checkbox"/>
o If "yes," would the proposed project result in 50 or more vehicle trips per project peak hour at any given intersection? <i>**It should be noted that the lead agency may require further analysis of intersections of concern even when a project generates fewer than 50 vehicles in the peak hour. See Subsection 313 of Chapter 16 for more information.</i>	<input checked="" type="checkbox"/>	<input type="checkbox"/>
o Would the proposed project result in more than 200 subway/rail or bus trips per project peak hour?	<input type="checkbox"/>	<input checked="" type="checkbox"/>
o If "yes," would the proposed project result, per project peak hour, in 50 or more bus trips on a single line (in one direction) or 200 subway trips per station or line?	<input type="checkbox"/>	<input type="checkbox"/>
o Would the proposed project result in more than 200 pedestrian trips per project peak hour?	<input checked="" type="checkbox"/>	<input type="checkbox"/>
o If "yes," would the proposed project result in more than 200 pedestrian trips per project peak hour to any given pedestrian or transit element, crosswalk, subway stair, or bus stop?	<input checked="" type="checkbox"/>	<input type="checkbox"/>
14. AIR QUALITY: CEQR Technical Manual Chapter 17		
(a) <i>Mobile Sources:</i> Would the proposed project result in the conditions outlined in Section 210 in Chapter 17 ?	<input type="checkbox"/>	<input checked="" type="checkbox"/>
(b) <i>Stationary Sources:</i> Would the proposed project result in the conditions outlined in Section 220 in Chapter 17 ?	<input checked="" type="checkbox"/>	<input type="checkbox"/>
o If "yes," would the proposed project exceed the thresholds in Figure 17-3, Stationary Source Screen Graph in Chapter 17 ? (Attach graph as needed) See attached report.	<input type="checkbox"/>	<input checked="" type="checkbox"/>
(c) Does the proposed project involve multiple buildings on the project site?	<input type="checkbox"/>	<input checked="" type="checkbox"/>
(d) Does the proposed project require federal approvals, support, licensing, or permits subject to conformity requirements?	<input type="checkbox"/>	<input checked="" type="checkbox"/>
(e) Does the proposed project site have existing institutional controls (e.g., (E) designation or Restrictive Declaration) relating to air quality that preclude the potential for significant adverse impacts?	<input type="checkbox"/>	<input checked="" type="checkbox"/>
15. GREENHOUSE GAS EMISSIONS: CEQR Technical Manual Chapter 18		
(a) Is the proposed project a city capital project or a power generation plant?	<input type="checkbox"/>	<input checked="" type="checkbox"/>
(b) Would the proposed project fundamentally change the City's solid waste management system?	<input type="checkbox"/>	<input checked="" type="checkbox"/>
(c) If "yes" to any of the above, would the project require a GHG emissions assessment based on the guidance in Chapter 18 ?	<input type="checkbox"/>	<input type="checkbox"/>
16. NOISE: CEQR Technical Manual Chapter 19		
(a) Would the proposed project generate or reroute vehicular traffic?	<input checked="" type="checkbox"/>	<input type="checkbox"/>
(b) Would the proposed project introduce new or additional receptors (see Section 124 in Chapter 19) near heavily trafficked roadways, within one horizontal mile of an existing or proposed flight path, or within 1,500 feet of an existing or proposed rail line with a direct line of site to that rail line?	<input checked="" type="checkbox"/>	<input type="checkbox"/>
(c) Would the proposed project cause a stationary noise source to operate within 1,500 feet of a receptor with a direct line of sight to that receptor or introduce receptors into an area with high ambient stationary noise?	<input type="checkbox"/>	<input checked="" type="checkbox"/>
(d) Does the proposed project site have existing institutional controls (e.g., (E) designation or Restrictive Declaration) relating to noise that preclude the potential for significant adverse impacts?	<input type="checkbox"/>	<input checked="" type="checkbox"/>
17. PUBLIC HEALTH: CEQR Technical Manual Chapter 20		
(a) Based upon the analyses conducted, do any of the following technical areas require a detailed analysis: Air Quality;	<input type="checkbox"/>	<input checked="" type="checkbox"/>

	YES	NO
Hazardous Materials; Noise?		
(b) If "yes," explain why an assessment of public health is or is not warranted based on the guidance in <u>Chapter 20</u> , "Public Health." Attach a preliminary analysis, if necessary.		
18. NEIGHBORHOOD CHARACTER: <u>CEQR Technical Manual Chapter 21</u>		
(a) Based upon the analyses conducted, do any of the following technical areas require a detailed analysis: Land Use, Zoning, and Public Policy; Socioeconomic Conditions; Open Space; Historic and Cultural Resources; Urban Design and Visual Resources; Shadows; Transportation; Noise?	<input checked="" type="checkbox"/>	<input type="checkbox"/>
(b) If "yes," explain why an assessment of neighborhood character is or is not warranted based on the guidance in <u>Chapter 21</u> , "Neighborhood Character." Attach a preliminary analysis, if necessary. See attached report.		
19. CONSTRUCTION: <u>CEQR Technical Manual Chapter 22</u>		
(a) Would the project's construction activities involve:		
o Construction activities lasting longer than two years?	<input checked="" type="checkbox"/>	<input type="checkbox"/>
o Construction activities within a Central Business District or along an arterial highway or major thoroughfare?	<input checked="" type="checkbox"/>	<input type="checkbox"/>
o Closing, narrowing, or otherwise impeding traffic, transit, or pedestrian elements (roadways, parking spaces, bicycle routes, sidewalks, crosswalks, corners, etc.)?	<input type="checkbox"/>	<input checked="" type="checkbox"/>
o Construction of multiple buildings where there is a potential for on-site receptors on buildings completed before the final build-out?	<input checked="" type="checkbox"/>	<input type="checkbox"/>
o The operation of several pieces of diesel equipment in a single location at peak construction?	<input type="checkbox"/>	<input checked="" type="checkbox"/>
o Closure of a community facility or disruption in its services?	<input type="checkbox"/>	<input checked="" type="checkbox"/>
o Activities within 400 feet of a historic or cultural resource?	<input type="checkbox"/>	<input checked="" type="checkbox"/>
o Disturbance of a site containing or adjacent to a site containing natural resources?	<input type="checkbox"/>	<input checked="" type="checkbox"/>
o Construction on multiple development sites in the same geographic area, such that there is the potential for several construction timelines to overlap or last for more than two years overall?	<input checked="" type="checkbox"/>	<input type="checkbox"/>
(b) If any boxes are checked "yes," explain why a preliminary construction assessment is or is not warranted based on the guidance in <u>Chapter 22</u> , "Construction." It should be noted that the nature and extent of any commitment to use the Best Available Technology for construction equipment or Best Management Practices for construction activities should be considered when making this determination. See attached report.		

20. APPLICANT'S CERTIFICATION

I swear or affirm under oath and subject to the penalties for perjury that the information provided in this Environmental Assessment Statement (EAS) is true and accurate to the best of my knowledge and belief, based upon my personal knowledge and familiarity with the information described herein and after examination of the pertinent books and records and/or after inquiry of persons who have personal knowledge of such information or who have examined pertinent books and records.

Still under oath, I further swear or affirm that I make this statement in my capacity as the applicant or representative of the entity that seeks the permits, approvals, funding, or other governmental action(s) described in this EAS.

APPLICANT/REPRESENTATIVE NAME John Strauss, Environmental Studies Corp.	DATE October 11, 2018
--	--------------------------

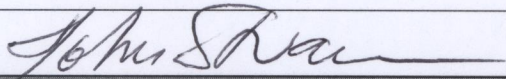
SIGNATURE 
--

PLEASE NOTE THAT APPLICANTS MAY BE REQUIRED TO SUBSTANTIATE RESPONSES IN THIS FORM AT THE DISCRETION OF THE LEAD AGENCY SO THAT IT MAY SUPPORT ITS DETERMINATION OF SIGNIFICANCE.

NEGATIVE DECLARATION (Use of this form is optional)

Statement of No Significant Effect

Pursuant to Executive Order 91 of 1977, as amended, and the Rules of Procedure for City Environmental Quality Review, found at Title 62, Chapter 5 of the Rules of the City of New York and 6 NYCRR, Part 617, State Environmental Quality Review, the Department of City Planning, acting on behalf of the City Planning Commission assumed the role of lead agency for the environmental review of the proposed project. Based on a review of information about the project contained in this environmental assessment statement and any attachments hereto, which are incorporated by reference herein, the lead agency has determined that the proposed project would not have a significant adverse impact on the environment.

Reasons Supporting this Determination

The above determination is based on information contained in this EAS, which finds the proposed actions sought before the City Planning Commission would have no significant effect on the quality of the environment. Reasons supporting this determination are noted below.

Hazardous Materials, Air Quality, Noise

An (E) designation (E-505) for Hazardous Materials, Air Quality, and Noise has been incorporated into the sites affected by the proposed actions. Refer to "Determination of Significance Appendix: (E) Designation" for a list of the sites affected by the proposed (E) designation and applicable requirements. With these measures in place, the proposed actions would not result in significant adverse impacts related to Hazardous Materials, Air Quality, or Noise.

Community Facilities and Services

A detailed analysis of Community Facilities and Services was conducted for Public School and Child Care, and no significant adverse impacts are expected as a result of the Proposed Actions.

Public Schools

Pursuant to CEQR Technical Manual methodology, a significant impact on schools may occur if the collective utilization rate of the elementary and/or intermediate schools in the Sub-district study that is equal to or greater than 100 percent in the With-Action Condition, and if the project results in an increase of five percent or more in the collective utilization rate between the No-Action and the With-Action conditions. With the Proposed Actions, the intermediate schools in Sub-district 1 would be slightly above 100 percent utilization (100.5 percent, a 1.3 percent increase from the No-Action Condition) while the elementary schools would be substantially more than 100 percent utilization (144.3 percent, a 1.4 percent increase from the No-Action Condition). Therefore, based on CEQR Technical Manual methodology, the Proposed Actions would not be expected to result in a significant adverse impacts on elementary or intermediate schools, and no further analysis of the Proposed Actions on public schools is required.

Project Name: Blondell Commons

CEQR #: 17DCP194X

SEQRA Classification: Unlisted

Child Care

The Proposed Actions would result in an increase of 9 percent in the collective utilization rate of the child care/Head Start centers in the study area, to 98.6 percent. Based on *CEQR Technical Manual* methodology, a significant adverse impact related to Child Care may occur if the collective utilization rate would be above 100 percent in the With-Action Condition and the increase would be greater than 5 percent. As the With-Action Condition would not meet both of these criteria, the Proposed Actions would not be expected to result in significant adverse impacts on publicly-financed child care facilities and no further analysis is required.

Open Space

A detailed analysis of Open Space was conducted. The Open Space analysis determines that the Proposed Actions would decrease the Open Space Ratio by 4.9 percent between No-Action and With-Action conditions. While this is below the CEQR Technical Manual threshold of a 5 percent decrease, a qualitative analysis was included and concludes that there are additional open space resources directly adjacent to the .5-mile Open Space study area that were not incorporated into the quantitative analysis. This includes approximately 207.4 acres of primarily passive open space part of the Hutchinson River Parkway Greenway extending between the Whitestone Bridge approach and the NYC border with Westchester County. Additionally, Bufano Park, a 1.9-acre playground and primarily active recreational resource, is adjacent to the Open Space study area and would be expected to be utilized by area residents in the With-Action condition. The Open Space analysis concludes that the Proposed Actions would not have any potentially significant adverse open space impacts and further assessment is not warranted.

Urban Design and Visual Resources

A detailed Urban Design analysis is included in the EAS. The analysis concludes that the Proposed Actions would not result in significant adverse impacts related to Urban Design and Visual Resources. There are two Open Space visual resources (Owen F. Dolen Park and Samuel H. Young Park) located within the rezoning area, neither of which would be affected by the Proposed Actions. The Proposed Actions also would not partially or totally block a view corridor or a natural or built resource that is rare in the area or considered a defining feature of the neighborhood.

No other significant effects upon the environment that would require the preparation of a Draft Environmental Impact Statement are foreseeable. This Negative Declaration has been prepared in accordance with Article 8 of the New York State Environmental Conservation Law (SEQRA)

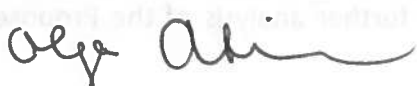
TITLE Acting Director, Environmental Assessment and Review Division	LEAD AGENCY Department of City Planning, acting on behalf of the City Planning Commission
NAME Olga Abinader	DATE 10/12/2018
SIGNATURE 	

Project Name: Blondell Commons

CEQR #: 17DCP194X

SEQRA Classification: Unlisted

TITLE Chair, City Planning Commission	
NAME Marisa Lago	DATE 10/15/18
SIGNATURE	

SEQRA Classification: Unlisted

Part III: DETERMINATION OF SIGNIFICANCE (To Be Completed by Lead Agency)

INSTRUCTIONS: In completing Part III, the lead agency should consult 6 NYCRR 617.7 and 43 RCNY § 6-06 (Executive Order 91 or 1977, as amended), which contain the State and City criteria for determining significance.

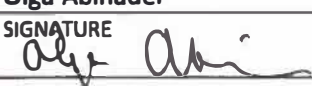
1. For each of the impact categories listed below, consider whether the project may have a significant adverse effect on the environment, taking into account its (a) location; (b) probability of occurring; (c) duration; (d) irreversibility; (e) geographic scope; and (f) magnitude.	Potentially Significant Adverse Impact	
	YES	NO
IMPACT CATEGORY		
Land Use, Zoning, and Public Policy	<input type="checkbox"/>	<input checked="" type="checkbox"/>
Socioeconomic Conditions	<input type="checkbox"/>	<input checked="" type="checkbox"/>
Community Facilities and Services	<input type="checkbox"/>	<input checked="" type="checkbox"/>
Open Space	<input type="checkbox"/>	<input checked="" type="checkbox"/>
Shadows	<input type="checkbox"/>	<input checked="" type="checkbox"/>
Historic and Cultural Resources	<input type="checkbox"/>	<input checked="" type="checkbox"/>
Urban Design/Visual Resources	<input type="checkbox"/>	<input checked="" type="checkbox"/>
Natural Resources	<input type="checkbox"/>	<input checked="" type="checkbox"/>
Hazardous Materials	<input type="checkbox"/>	<input checked="" type="checkbox"/>
Water and Sewer Infrastructure	<input type="checkbox"/>	<input checked="" type="checkbox"/>
Solid Waste and Sanitation Services	<input type="checkbox"/>	<input checked="" type="checkbox"/>
Energy	<input type="checkbox"/>	<input checked="" type="checkbox"/>
Transportation	<input type="checkbox"/>	<input checked="" type="checkbox"/>
Air Quality	<input type="checkbox"/>	<input checked="" type="checkbox"/>
Greenhouse Gas Emissions	<input type="checkbox"/>	<input checked="" type="checkbox"/>
Noise	<input type="checkbox"/>	<input checked="" type="checkbox"/>
Public Health	<input type="checkbox"/>	<input checked="" type="checkbox"/>
Neighborhood Character	<input type="checkbox"/>	<input checked="" type="checkbox"/>
Construction	<input type="checkbox"/>	<input checked="" type="checkbox"/>
2. Are there any aspects of the project relevant to the determination of whether the project may have a significant impact on the environment, such as combined or cumulative impacts, that were not fully covered by other responses and supporting materials? If there are such impacts, attach an explanation stating whether, as a result of them, the project may have a significant impact on the environment.	<input type="checkbox"/>	<input checked="" type="checkbox"/>
3. Check determination to be issued by the lead agency:		
<input type="checkbox"/> Positive Declaration: If the lead agency has determined that the project may have a significant impact on the environment, and if a Conditional Negative Declaration is not appropriate, then the lead agency issues a <i>Positive Declaration</i> and prepares a draft Scope of Work for the Environmental Impact Statement (EIS).		
<input type="checkbox"/> Conditional Negative Declaration: A <i>Conditional Negative Declaration</i> (CND) may be appropriate if there is a private applicant for an Unlisted action AND when conditions imposed by the lead agency will modify the proposed project so that no significant adverse environmental impacts would result. The CND is prepared as a separate document and is subject to the requirements of 6 NYCRR Part 617.		
<input checked="" type="checkbox"/> Negative Declaration: If the lead agency has determined that the project would not result in potentially significant adverse environmental impacts, then the lead agency issues a <i>Negative Declaration</i> . The <i>Negative Declaration</i> may be prepared as a separate document (see template) or using the embedded Negative Declaration on the next page.		
4. LEAD AGENCY'S CERTIFICATION		
TITLE Acting Director, Environmental Assessment and Review Division	LEAD AGENCY Department of City Planning, acting on behalf of the City Planning Commission	
NAME Olga Abinader	DATE October 12, 2018	
SIGNATURE 		

Appendix 1: (E) Designations

Hazardous Materials

The (E) Designation requirements for Hazardous Materials are as follows:

Block 4134, Lot 1, and Block 4133, Lots 1, 2, 10, 61, 62, and 63

Task 1- Sampling Protocol

The applicant submits to OER, for review and approval, a Phase I of the site along with a soil, groundwater and soil vapor testing protocol, including a description of methods and a site map with all sampling locations clearly and precisely represented. If site sampling is necessary, no sampling should begin until written approval of a protocol is received from OER. The number and location of samples should be selected to adequately characterize the site, specific sources of suspected contamination (i.e., petroleum based contamination and non-petroleum based contamination), and the remainder of the site's condition. The characterization should be complete enough to determine what remediation strategy (if any) is necessary after review of sampling data. Guidelines and criteria for selecting sampling locations and collecting samples are provided by OER upon request.

Task 2-Remediation Determination and Protocol

A written report with findings and a summary of the data must be submitted to OER after completion of the testing phase and laboratory analysis for review and approval. After receiving such results, a determination is made by OER if the results indicate that remediation is necessary. If OER determines that no remediation is necessary, written notice shall be given by OER. If remediation is indicated from test results, a proposed remediation plan must be submitted to OER for review and approval. The applicant must complete such remediation as determined necessary by OER. The applicant should then provide proper documentation that the work has been satisfactorily completed.

A construction-related health and safety plan should be submitted to OER and would be implemented during excavation and construction activities to protect workers and the community from potentially significant adverse impacts associated with contaminated soil, groundwater and/or soil vapor. This plan would be submitted to OER prior to implementation.

Air Quality

The (E) Designation requirements for Air Quality are as follows:

Block 4134, Lot 1 (Projected Development Site 1): Any new residential or commercial development on the above-referenced property must exclusively use natural gas as the type of fuel for heating, ventilating, air

Project Name: Blondell Commons
CEQR #: 17DCP194X
SEQRA Classification: Unlisted

conditioning (HVAC) systems and ensure that the HVAC stack(s) is located at the highest tier and at least 98 feet above the grade to avoid any potential significant adverse air quality impacts.

To preclude the potential for significant adverse air quality impacts from the emissions sources located on Blondell Avenue (1341 Blondell Avenue [Block 4072, Lot 19], 1364 Blondell Avenue [Block 4072, Lot 19], and 1345 Blondell Avenue [Block 4072, Lot 19]), no operable windows or air intakes would be permitted on certain limited areas of the western and northern façades of any new residential development located on Block 4134, Lot 1, as identified below:

Block 4134, Lot 1 (Projected Development Site 1): Blondell Avenue Façade	
Grade Level:	Restriction Location:
Ground Floor (0-15 feet above grade)	0-30 feet measuring from the southeast lot line.
Second Floor (15-25 feet above grade)	Measuring from the southeast lot line: <ul style="list-style-type: none"> • 0-45 feet; • 83-128 feet; and • 140-206 feet
Third Floor (25-35 feet above grade)	Measuring from the southeast lot line: <ul style="list-style-type: none"> • 0-35 feet; and • 160-206 feet.
Block 4134, Lot 1 (Projected Development Site 1): Ponton Avenue Façade	
Grade Level:	Restriction Location:
Second Floor (15-25 feet above grade)	0-15 feet measuring from the lot line facing Blondell Avenue.
Third Floor (25 to 35 feet above grade)	0-15 feet measuring form the lot line facing Blondell Avenue.

Block 4133, Lot 1 (Projected Development Site 2): Any new residential or commercial development on the above-referenced property must exclusively use natural gas as the type of fuel for heating, ventilating, air conditioning (HVAC) systems and ensure that the HVAC stack(s) is located at the highest tier and at least 98 feet above the grade and at least 55 feet from the lot line facing Cooper Avenue to avoid any potential significant adverse air quality impact.

Block 4133, Lot 2 (Projected Development Site 3): Any new residential or commercial development on the above-referenced property must exclusively use natural gas as the type of fuel for heating, ventilating, air conditioning (HVAC) systems and ensure that the HVAC stack(s) is located at the highest tier and at least 98 feet above the grade and at least 55 feet from the lot line facing Cooper Avenue to avoid any potential significant adverse air quality impact.

Block 4133, Lot 63 (Projected Development Site 4): Any new residential or commercial development on the above-referenced property must exclusively use natural gas as the type of fuel for heating, ventilating, air conditioning (HVAC) systems and ensure that the HVAC stack(s) is located at the highest tier and at least 98 feet

Project Name: Blondell Commons
CEQR #: 17DCP194X
SEQRA Classification: Unlisted

above the grade and at least 20 feet from the lot line facing Cooper Avenue to avoid any potential significant adverse air quality impacts.

Block 4133, Lot 10 (Projected Development Site 5): Any new residential or commercial development on the above-referenced property must exclusively use natural gas as the type of fuel for heating, ventilating, air conditioning (HVAC) systems and ensure that the HVAC stack(s) is located at the highest tier and at least 98 feet above the grade and at least 55 feet from the lot line facing Cooper Avenue to avoid any potential significant adverse air quality impact.

To preclude the potential for significant adverse air quality impacts from the emissions sources located on Blondell Avenue (1341 Blondell Avenue [Block 4072, Lot 19], 1364 Blondell Avenue [Block 4072, Lot 19], and 1345 Blondell Avenue [Block 4072, Lot 19]),, no operable windows or air intakes would be permitted on certain limited areas of the northern and western façades of any new residential development located on Block 4133, Lot 10, as identified below in Table 1.

Block 4133, Lot 10 (Projected Development Site 5): Blondell Avenue Façade	
Grade Level:	Restriction Location:
Ground Floor (0-15 feet above grade)	0-15 feet measuring from the northern lot line.
Second Floor (15-25 feet above grade)	Complete façade facing Blondell Avenue: from the northern lot line to the southern lot line
Block 4133, Lot 10 (Projected Development Site 5): Northern Façade	
Grade Level:	Restriction Location:
Second Floor (15-25 feet above grade)	Measuring from the lot line facing Blondell Avenue: <ul style="list-style-type: none"> • 25-35 feet.

Block 4133, Lots 61 and 62 (Projected Development Site 6): Any new residential or commercial development on the above-referenced property must exclusively use natural gas as the type of fuel for heating, ventilating, air conditioning (HVAC) systems and ensure that the HVAC stack(s) is located at the highest tier and at least 98 feet above the grade and at least 20 feet from the lot line facing Cooper Avenue to avoid any potential significant adverse air quality impacts.

Noise

The (E) Designation requirements for Noise are as follows:

Block 4134, Lot 1 (Projected Development Site 1): To ensure an acceptable interior noise environment, future residential/community facility/ commercial uses must provide a closed-window condition with a minimum of 28 dB(A) window/wall attenuation on all facades facing west (Blondell Avenue) and 31 dB(A) of attenuation on all other facades to maintain an interior noise level of 45 dB(A). To maintain a closed-window condition, an alternate means of ventilation must also be provided. Alternate means of ventilation includes, but is not limited to, air conditioning.

Project Name: Blondell Commons

CEQR #: 17DCP194X

SEQRA Classification: Unlisted

Block 4133, Lot 1 (Projected Development Site 2): In order to ensure an acceptable interior noise environment, future residential/ commercial uses must provide a closed window condition with a minimum of 38 dB(A) window/wall attenuation on all building's facades in order to maintain an interior noise level of 45 dB(A). In order to maintain a closed-window condition, an alternate means of ventilation must also be provided. Alternate means of ventilation includes, but is not limited to, central air conditioning or air conditioning sleeves containing air conditioners.

Block 4133, Lot 2 (Projected Development Site 3): In order to ensure an acceptable interior noise environment, future residential/ commercial uses must provide a closed window condition with a minimum of 38 dB(A) window/wall attenuation on all building's facades in order to maintain an interior noise level of 45 dB(A). In order to maintain a closed-window condition, an alternate means of ventilation must also be provided. Alternate means of ventilation includes, but is not limited to, central air conditioning or air conditioning sleeves containing air conditioners.

Block 4133, Lot 63 (Projected Development Site 4): In order to ensure an acceptable interior noise environment, future residential/commercial uses must provide a closed window condition with a minimum of 38 dB(A) window/wall attenuation on all building's facades in order to maintain an interior noise level of 45 dB(A). In order to maintain a closed-window condition, an alternate means of ventilation must be provided. Alternate means of ventilation includes, but is not limited to, central air conditioning or air conditioning sleeves containing air conditioners.

Block 4133, Lot 10 (Projected Development Site 5): In order to ensure an acceptable interior noise environment, future residential/ commercial uses must provide a closed window condition with a minimum of 28 dB(A) window/wall attenuation on all facades facing west (Blondell Avenue) and 31 dB(A) of attenuation on all other facades in order to maintain an interior noise level of 45 dB(A). To maintain a closed-window condition, an alternate means of ventilation must also be provided. Alternate means of ventilation includes, but is not limited to, air conditioning.

Block 4133, Lots 61 and 62 (Projected Development Site 6): In order to ensure an acceptable interior noise environment, future residential/ commercial uses must provide a closed-window condition with a minimum of 38 dB(A) on all building's facades in order to maintain an interior noise level of 45 dB(A). In order to maintain a closed-window condition, an alternate means of ventilation must be provided. Alternate means of ventilation includes, but is not limited to, central air conditioning or air conditioning sleeves containing air conditioners.

BLONDELL COMMONS PROJECT DESCRIPTION

Reasonable Worst-Case Development Scenario

INTRODUCTION

The Applicant, HP MJM Housing Development Fund Company, Inc. as legal owner and Blondell Equities LLC, as beneficial owner, is proposing the following Proposed Actions:

- A Zoning Map Amendment from an existing M1-1 district to an R7A/C2-4 district of properties bounded by Blondell Avenue, Ponton Avenue, Westchester Avenue, and the NYC Transit Yard in the Westchester Square neighborhood of the Bronx, Community District 11. This would involve a rezoning of the Applicant's property, Block 4134, Lot 1 (formerly Block 4134, Lots 1, 2, 4, 62, 63, and 70 and Block 4133, Lot 12), and non-Applicant properties, identified as Block 4133, Lots 1, 2, 8 (partial as the Fink Avenue portion of this lot is not zoned and is to be demapped in association with a change to the City Map), 10, 61, 62, and 63 (partial as a portion of this lot is located outside of the rezoning area boundary) plus 50% of the to be demapped portion of Ponton Avenue (Block 4134, Lot 14-partial) adjacent to the rezoning area.
- A Zoning Text Amendment to modify ZR §23-933, Appendix F to designate the newly mapped R7A/C2-4 district as a Mandatory Inclusionary Housing designated area.
- A demapping of Fink Avenue between Blondell and Waters Avenues.

The proposed project on Projected Development Site 1 is the development of a new nine-story and cellar, 95'-0" tall mixed-use building totaling 261,660 gross square feet (gsf) [including cellar area] and containing 228 dwelling units within 198,683 gsf on floors 1-9 (plus 7,558 gsf of cellar space). 227 of the 228 units would be considered affordable with 65% or 148 units at 80% of Area Median Income (AMI) or less and 35% or 79 units at 100% AMI or less as approved by HPD. One dwelling unit would be provided for the building superintendent and is not included in the affordability breakdown. The development would also contain 19,668 gsf of retail space and 2,024 gsf of community facility space. The development would include 225 attended accessory parking spaces.

The remainder of the Proposed Rezoning Area, Block 4133, Lots 1, 2, 8 (partial), 10, 61, 62, and 63 (partial) plus 50% of the to be demapped portion of Ponton Avenue (Block 4134, Lot 14-partial) adjacent to the rezoning area, is not proposed for development and is not controlled by the Applicant. However, it is anticipated that new development would occur on five Projected Development Sites as follows.

Projected Development Site 2 (Block 4133, Lot 1) would be developed with a 9-story, 95'-0" tall, 13,616 gsf mixed use building containing 11,686 gsf of residential floor area for 13 dwelling units, 3 of which would be affordable at 80% AMI. The development would also include 1,930 gsf of ground floor commercial space. Parking would be waived.

Projected Development Site 3 (Block 4133, Lot 2) would be developed with a 9-story, 95'-0" tall, 64,552 gsf mixed use building containing 42,745 gsf of residential floor area for 49 dwelling units, 10 of which would be affordable at 80% AMI. The development would also include 10,557 gsf of ground floor commercial space and 11,250 gsf for cellar level parking. 19 cellar level parking spaces would be provided on the Site.

Projected Development Site 4 (Block 4133, Lot 63 [p/o]) would be developed with a 9-story, 95'-0" tall, 66,922 gsf mixed use building containing 45,989 gsf of residential floor area for 53

dwelling units, 11 of which would be affordable at 80% AMI. The development would also include 9,270 gsf of ground floor commercial space and 11,663 gsf for cellar level parking. 21 cellar level parking spaces would be provided on the Site.

Projected Development Site 5 (Block 4133, Lot 10) would be developed with a 9-story, 95'-0" tall, 23,453 gsf mixed use building containing 19,385 gsf of residential floor area for 22 dwelling units, 5 of which would be affordable at 80% AMI. The development would also include 4,068 gsf of ground floor commercial space. Parking would be waived.

Projected Development Site 6 (Block 4133, Lots 61 & 62) would be developed with a 9-story, 95'-0" tall, 19,625 gsf mixed use building containing 16,389 gsf of residential floor area for 19 dwelling units, 4 of which would be affordable at 80% AMI. The development would also include 3,236 gsf of ground floor commercial space. Parking would be waived.

ACTIONS NECESSARY TO FACILITATE THE PROPOSAL

The Applicant, HP MJM Housing Development Fund Company, Inc. as legal owner and Blondell Equities LLC, as beneficial owner, proposes the following actions:

- I. A zoning map amendment from an M1-1 to a R7A/C2-4 district which would involve a rezoning of the Applicant's property, Block 4134, Lot 1 (formerly Block 4134, Lots 1, 2, 4, 62, 63, and 70 and Block 4133, Lot 12), and non-Applicant properties, identified as Block 4133, Lots 1, 2, 8 (partial), 10, 61, 62, and 63 (partial). 50% of the portion of Ponton Avenue (Block 4134, Lot 14-partial) adjacent to the Applicant's property is also included, but will not be acquired by the Applicant, and is proposed to be zoned R7A/C2-4. The Ponton Avenue Demapping (C110342MMX) was recently adopted by the City Council but the map has not been filed and the map change has not been effectuated. Ponton Avenue is still a mapped City street pending the execution of a mapping agreement between the Applicant and the City.
- II. A zoning text amendment to modify ZR §23-933, Appendix F to designate the newly mapped R7A/C2-4 district as a Mandatory Inclusionary Housing designated area. 227 of the 228 units would be considered affordable with 65% or 148 units at 80% of AMI or less and 35% or 79 units at 100% AMI or less as approved by HPD on the Applicant Site. One dwelling unit would be provided for the building superintendent and is not included in the affordability breakdown. 20% of the dwelling units on the Non-Applicant Sites would be considered affordable at 80% AMI.
- III. A change to the City Map that involves the elimination, discontinuance and closing of Fink Avenue between Blondell Avenue and Waters Avenue (Block 4133, part of Lot 8), and the adjustment of grades necessitated thereby, including authorization for any acquisition or disposition of real property related thereto (demap a mapped but unbuilt portion of Fink Avenue that traverses the Development Site). A draft mapping application was submitted to the NYC Department of City Planning (DCP) on September 7, 2016.
- IV. In a related action, the project will undergo a coordinated review with the NYC Department of Housing Preservation and Development (HPD) because the project seeks discretionary financing.

DESCRIPTION OF THE SURROUNDING AREA

The area surrounding the Rezoning Area is characterized by a wide variety of land uses including both single and multi-family residential, mixed use (residential-commercial),

commercial, manufacturing, transportation/utilities, automotive/parking, and several parks and other community facilities. The New York City Transit's (NYCT) 6-Train elevated subway line runs to the south of the Rezoning Area. The extent of the area is generally defined by a large NYCT Train Yard and the Hutchinson River Parkway, located to the east, a manufacturing district and Westchester Creek to the south, and an Amtrak/Metro-North rail right-of-way located to the north.

There are retail uses fronting on East Tremont Avenue (in close proximity to the Westchester Square elevated subway station) in the area that is currently an R6 district with a C1-2 commercial overlay, and light manufacturing, warehouse, storage yard, and automotive uses throughout the remainder of the area that is currently an M1-1 district.

To the southwest and west of the Rezoning Area is an R6/C1-2 district, which contains retail uses consisting of newsstands, eating and drinking establishments, variety and discount stores, and other convenience retail uses. Most of these are located in one-story buildings, or on the ground floor of two and three-story buildings (with either residential, or office use, above). Said buildings are built to the street line, and do not offer off-street parking, reflecting the pedestrian-oriented nature of the neighborhood.

Residential uses are mostly concentrated in the area to the west and northwest of the Rezoning Area. These neighborhoods include both single- and multi-family residential buildings. Smaller density buildings are either detached, semi-detached, and attached homes of between 1-3 stories, and multi-family apartments buildings rise to 6-stories. The development of these properties predates the mapping of the underlying M1-1 zoning district.

The area's commercial uses are centered around the Westchester Square elevated subway stop, and the portion of East Tremont Avenue running northwest there from, which is the neighborhood's principal shopping street. Such commercial use is primarily retail stores, which are located in purely commercial buildings of 1 and 2 stories, and in the ground floor of mixed-use building that include residential use above.

Manufacturing, transportation/utility, and automotive-related uses are mostly located in the underlying M1-1 district (to the north, south, east, and west of the Applicant Site), and in the smaller M3-1 district located to the south along Westchester Creek. Central among such uses is the NYCT Train Yard that is located adjacent to the east of the Applicant Site that measures approximately 750 feet by 2,000 feet, and consumes most of blocks 4133, 4134, 4137, 4138, 4139, 4140, 4141, 4142 and 4143. The remaining uses are light manufacturing, warehouse, and automotive uses, such as repair shops. These are generally located in one- and two-story detached buildings, and often have adjacent parking or storage yards.

Scattered throughout the surrounding area are a number of parks and other community facilities. Adjacent to the southwest of the proposed Rezoning Area, Owen F. Dolen Park is located in the triangular area bound by East Tremont Avenue, Westchester Avenue and Lane Avenue, adjacent to the Westchester Square elevated subway stop. One block to the east of the Rezoning Area, Samuel H. Young Park occupies the majority of Block 5380. One block southeast of the proposed Rezoning Area is the campus of Herbert H. Lehman High School (Block 5368, Lots 1 and 2), which spans the Hutchinson River Parkway. To the east of the Rezoning Area, beyond the Train Yard, is P.S. 271 – the Steven McSweeney School (Block 4133, Lot 200). Further to the northeast, is the massive campus of the Bronx Psychiatric Center; to the northwest is the Calvary Hospital. Aside from these notable

examples, there are also a number of other smaller community facilities such as small houses of worship, libraries, schools, and a post office located in the surrounding area.

The existing zoning of the surrounding area predominantly consists of an R6 district located to the west and northwest of the Rezoning Area, with C1-2, C1-4, C2-2 and C2-4 commercial overlay districts mapped along portions of Westchester Avenue, East Tremont Avenue, and Williamsbridge Road; and the M1-1 district in which the Applicant Site is located, which extends to the north and south. A small area south of the Rezoning Area (along Westchester Creek) is a M3-1 district, as noted above; to the east of the Rezoning Area (on the far side of the Train Yard, and generally beyond 600 feet) are R4-1, R5 and R7-1 districts.

C1 and C2 are commercial overlay districts. C1 commercial overlays permit 1.0 FAR (in districts below R6) and 2.0 FAR (in districts above R6) of commercial retail (Use Groups 5-6). C2 commercial overlays permit the same level of density but allow an increased range of commercial uses (Use Groups 5-9). The C1-2, C1-4, C2-2 and C2-4 districts primarily vary in terms of accessory parking requirements.

The surrounding R6 district allows residential as well as community facility uses. The bulk parameters of the district allow for buildings up to 2.43 FAR, in a variety of building types, generally designed under the height factor (building height controlled by sky exposure plane) or quality housing (70 foot maximum building height) rules. While a 30-foot rear yard is required, front and side yards are not. Off-street parking is required in R6 districts for 70% of dwelling units under height factor regulations.

The R4-1 district primarily permits contextual one and two-family detached and semi-detached houses at a maximum FAR of 0.75, with an attic allowance of 20%. Front yards of 10 feet and rear yards 30 feet are required, with side yards of at least four feet. The maximum building height is 35 feet and one parking space is required per dwelling unit.

The R5 district is a low-density general residence district that permits residential buildings up to 1.25 FAR and community facility buildings up to 2.0 FAR. The maximum height of buildings within R5 districts is 40 feet, with a maximum street wall height of 30 feet, as well as a 15-foot setback above the street wall. R5 districts require side yards of at least 8 feet and a 10-foot front yard. Parking is required for 85% of dwelling units.

The R7-2 district permits residential and community facility use at a maximum floor area ratio (FAR) of 3.44 for residential use and 6.5 for community facility use. The maximum height of residential buildings in R7-2 districts is regulated by the sky exposure plane, which begins at a height of 60 feet above the front lot line.

The surrounding M1-1 district allows for a variety of light manufacturing uses such as repair shops, wholesale service and storage facilities, as well as heavier industrial uses subject to stringent performance standards. The bulk parameters of the district allow for buildings up to 1.0 FAR for manufacturing and commercial uses and 2.4 for community facility uses, built to the front and side lot lines, with a 20 foot rear yard. Building heights are regulated by a 1:1 sky exposure plane beginning at 30 feet (or two stories) above the street line. Off-street parking and loading facilities are required in M1-1 districts according to the type and size of the use on the property.

On March 22, 2006 the Westchester Square Rezoning was approved (ULURP Application No.: C 060180 ZMX; CEQR No.: 06DCP034X). That action rezoned 17 full blocks and portions of 19 blocks, and modified commercial overlay districts, in the Westchester Square neighborhood. The purpose of the rezoning was to map contextual zoning districts that

would better reflect the scale and character of the Westchester Square neighborhood and ensure that future development fit the prevailing neighborhood context of mid-density residential development. The rezoning also preserved the context of large detached single- and two-family homes in the inner blocks and apartment buildings along wider avenues in the rezoning area.

In addition, 22 commercial overlays were modified to reduce parking requirements on shopping streets close to transit, eliminate one entire commercial overlay and part of another, and add one new commercial overlay. The depth of existing 150-foot commercial overlays was also reduced to 100 feet.

Most of the rezoning area was located north of Westchester Avenue, generally bounded by East Tremont Avenue and Castle Hill Avenue. The remaining portion was located south of Westchester Avenue, generally bounded by Seabury, Zerega and Waterbury Avenues. (All of which area is located to the west and south of the proposed Rezoning Area.)

In 2008, two applications were filed to facilitate the development of a new seven-story mixed-use building on the Applicant Site. (ULURP Application Nos: 090085ZMX and 090086ZSX, CEQR No.: 09DCP008X; requesting a zoning map amendment and a special permit per ZR §74-512, respectively.) ULURP Application No.: 090085ZMX requested two zoning map amendments to rezone a portion of the M1-1 district to an R7-1 district, and to map a C2-4 overlay district in a portion of the proposed R7-1 district. ULURP Application No.: 090086ZSX requested a special permit pursuant to ZR §74-512 to allow for an off-street public parking facility to include 411 parking spaces. These applications were filed on August 19, 2008, but never reached certification. This application is a revision to the previously filed zoning map change application (ULURP Application No.: 090085ZMX); the previously filed special permit application to facilitate public parking (ULURP Application No.: 090086ZSX) will be withdrawn.

Most recently, a City Map change was approved in January of 2014, which affects an area adjacent to the proposed Rezoning Area (ULURP Application No.: 110342MMX; CEQR No.: 11DCP136X). This application involved the elimination, discontinuance, and closing of Ponton Avenue between Blondell Avenue and Waters Avenue (Block 4134, p/o Lot 14; Block 4139 p/o Lots 14, 101), and the adjustment of block dimensions and legal grades related thereto. The objective of this application was to facilitate the sale of the existing street area for use as accessory parking to an existing automotive repair shop. It should be noted this action was unrelated to this application, but falls adjacent to the Applicant Site.

DESCRIPTION OF THE AFFECTED AREA

The Affected Area includes the Applicant's property, Block 4134, Lot 1 (formerly Block 4134, Lots 1, 2, 4, 62, 63, and 70 and Block 4133, Lot 12), and Non-Applicant properties, identified as Block 4133, Lots 1, 2, 8 (partial), 10, 61, 62, and 63 (partial) plus 50% of the to be demapped portion of Ponton Avenue (Block 4134, Lot 14-partial) adjacent to the rezoning area. The existing conditions on these lots are described below.

Project Site (Applicant-Owned)

Block 4134, Lot 1 - This property consists of the following former lots, all of which are zoned M1-1. Per survey dated 11/03/16, the property consists of 46,360 sf of land area developed with 6,210 gsf of building floor area, which represents an FAR of 0.13 (0.02 residential, 0.02 commercial, and 0.10 manufacturing).

- Block 4133, Lot 12 and Block 4134, Lots 62 & 63 are used for vehicle parking and vehicle storage in connection with a towing facility.
- Block 4134, Lot 70 is vacant land used as a street (Cooper Avenue between Ponton and Fink Avenues)
- Block 4134, Lot 2 contains a one-story 4,500 gsf auto body repair facility (Caveman Cycles) occupying the entire lot.
- Block 4134, Lot 4 contains a two-story 944 gsf building used for offices (Darkside Collision + Tow), vehicle parking, and vehicle storage in connection with the towing facility.
- Block 4134, Lot 1 contains a one- to two-story 766 gsf residential structure containing 1 dwelling unit (currently vacant).

Non-Applicant Owned Sites

The Non-Applicant properties, all of which are zoned M1-1, are described as follows:

Block 4133, Lot 1 - The 2,874 sf lot is developed with two 1-story buildings totaling 1,075 gsf in size and used for automobile repair and storage; FAR of 0.37.

Block 4133, Lot 2 - The 11,250 sf lot is developed with a 1-story building totaling 24,900 gsf in size and used for office space, a garage, and related uses; FAR of 2.21.

Block 4133, Lot 8 - The cross-shaped 18,022 sf lot is designated and used as a driveway to adjacent parcels (a portion of Fink Avenue [aka Grant Avenue] between Blondell Avenue and the MTA train yard and a portion of Cooper Avenue between Westchester Avenue and Lot 70 described above).

Block 4133, Lot 10 - The 4,950 sf lot is developed with a 2-story building totaling 13,230 gsf in size and used for 4 dwelling units (4,410 gsf) and 8,820 gsf of retail space; FAR of 2.67.

Block 4133, Lot 61- The 1,642 sf lot is developed with a 2-story building totaling 3,040 gsf in size and used for office and retail space; FAR of 1.85.

Block 4133, Lot 62 - The 2,500 sf lot is developed with a 1-story building totaling 2,000 gsf in size and used for retail space; FAR of 0.8.

Block 4133, Lot 63 - The 11,663 sf lot is developed with a 1-story building totaling 1,200 gsf in size and used for storage; FAR of 0.1.

Block 4134, Lot 14 (partial) - 50% of the to be demapped portion of Ponton Avenue consists of 7,687 sf area of demapped street.

DESCRIPTION OF THE PROPOSED DEVELOPMENT

As mentioned above, the Applicant intends to rezone portions of Blocks 4133 and 4134, the Rezoning Area, from an M1-1 to an R7A/C2-4 district. The district allows a residential base FAR of 4.0 with a residential FAR of 4.6 permitted as a bonus for inclusionary housing. It would also allow a commercial FAR of 2.0 and a community facility FAR of 4.0. It would allow Use Group 6 commercial retail and office uses and also expand the scope of permitted commercial uses to include Use Groups 7B, 8, 9, and 14, which are not permitted in the nearby C1 commercial districts. The district would permit Use Group 3 and 4 community facilities including such uses as educational facilities, houses of worship, and medical office uses.

The proposed R7A/C2-4 zone would facilitate the development on the Applicant's property of a new nine-story and cellar, 95'-0" tall mixed-use building totaling 261,660 gsf (including cellar area) and 211,500 zoning square feet (zsf) on the 46,360 sf lot representing an FAR of 4.56 and containing the following:

The building would contain 228 dwelling units within 189,808 zsf (FAR of 4.09) and 198,683 gsf on floors 1-9 (plus 7,558 gsf of cellar space) comprised of 48 studio apartments (21%), 80 one-bedroom apartments (35%), 60 two-bedroom apartments (26%), and 40 three-bedroom apartments (18%). 227 of the 228 units would be considered affordable with 65% or 148 units at 80% of AMI or less and 35% or 79 units at 100% AMI or less as approved by HPD. One dwelling unit would be provided for the building superintendent and is not included in the affordability breakdown. Funding would be provided by HPD and either the NYS Housing Finance Agency or the NYC Housing Development Corporation, with 4% Low-Income Housing Tax Credits. The project would also most likely require monies from the Borough President's Office and the City Council (Resolution A). The average unit size would be 871 sf (excluding cellar area).

The building would contain 19,668 gsf/zsf (FAR of 0.42) of retail space on the first/ground floor. Anticipated retail uses include clothing and furniture stores of up to 19,668 gsf in floor area, a possible supermarket of up to 10,000 gsf in size, and/or a large chain restaurant.

The building would contain 2,024 gsf/zsf (FAR of 0.04) of community facility space on the first floor. Possible retail community facility uses could include a day care center and medical offices.

Per ZR Sections 25-251, 36-21, and 44-21, 225 attended accessory parking spaces would be provided, including 128 residential spaces, 95 commercial spaces, and 2 community facility spaces within 33,727 gsf in the cellar and on the first floor of the building. The underground parking garage would be accessed via an entrance at the north end of the Project Site on Blondell Avenue.

The development would contain indoor recreational facilities totaling 5,773 sf in area which would include an approximately 1,090 sf children's playroom, an approximately 1,454 sf fitness room, and an approximately 3,229 sf multi-purpose room on the first floor of the building. An approximately 10,011 sf passive outdoor recreational area and a second approximately 2,686 sf passive outdoor recreational area would be provided at the rear of the building.

The proposed development would consist of a one-story base which would cover approximately 24,022 zsf or 51.8% of the 46,360 sf Project Site, upon which six additional floors would be built to a height of 75'-0" before setback. A portion of the 8th and 9th floors of the building would be set back 15'-0" from the Blondell Street frontage of the property to a building height at the roof of 95'-0", which is the maximum permitted building height for a building with a qualifying ground floor (5 additional feet per ZR 23-664). The project would be developed in accordance with the Zoning for Quality and Affordability (ZQA) provisions of the Zoning Resolution. A 30'-0" rear yard would be provided behind the building.

The existing structures and uses on the Site would be demolished and removed.

A part of this application, the mapped but unbuilt portion of Fink Avenue, which comprises the vehicular and pedestrian easement extending from Blondell Avenue through the Project Site, would be demapped. Cooper Avenue and Grant Streets cannot be used as egress for the proposed development. Egress would be provided onto Blondell Avenue.

BUILD YEAR/PROJECT PHASING

Based on an estimated 12-month approval process and a 24-month construction period, the Build Year for the Applicant Controlled Site is assumed to be 2022. As the Proposed Actions would result in the creation of multiple Development Sites that are not controlled by the Applicant, it is anticipated that these Sites would be developed over a seven year period with a Build Year of 2029.

PURPOSE AND NEED OF THE PROPOSED ACTIONS

The Applicant seeks to redevelop Projected Development Site 1, identified as Block 4134, Lot 1 in the Bronx, primarily for residential purposes with accessory retail and community facility space and accessory parking to serve project residents and other persons in the surrounding community.

The proposed Zoning Map Change would include rezoning the Applicant Owned Projected Development Site 1 from its existing M1-1 district to the proposed R7A/C2-4 district which is required in order to develop residential uses on the property. It is also required to allow the proposed bulk of the new building to be increased from the current permitted FAR of 1.0 for manufacturing and commercial uses and 2.4 for community facility uses to 4.0 for all permitted residential and community facility uses (manufacturing uses would not be allowed), 2.0 for commercial uses, and 4.6 as a bonus for inclusionary housing.

The proposed zoning text amendment to modify ZR §23-933, Appendix F is necessary in order to make the newly mapped R7A/C2-4 district a Mandatory Inclusionary Housing designated area. The text amendment is needed to provide the floor area needed to permit buildings that will be providing a large percentage of low- and middle-income dwelling units.

As part of this application, the Applicant is requesting a change to the City Map that involves the elimination, discontinuance and closing of Fink Avenue (between Blondell Avenue and Waters Avenue (Block 4133, part of Lot 8), and the adjustment of grades necessitated thereby, including authorization for any acquisition or disposition of real property related thereto (demap a mapped but unbuilt portion of Fink Avenue that traverses the Development Site).

The subject portion of Fink Avenue (hereafter "the street to be eliminated") is owned by the Metropolitan Transportation Authority and other private parties, is mapped to a width of 60 feet, is not open to traffic, and is not improved. The majority of the street to be eliminated is within a NYC Transit Maintenance Yard. Multiple train tracks, including an elevated subway line, cross over the street within the Maintenance Yard. The Yard is approximately zero feet to 17 feet below the grade of the surrounding streets and approximately five feet below the Applicant's property (on average). The total area of the street to be closed is 40,677.14 square feet.

The northeasterly portion of the street to be eliminated is a NYC Transit Maintenance Yard (Block 4133, Lot 23; Block 4134, Lot 14); the southwesterly portion includes parts of several privately-owned lots (Block 4133, Lots 8, 10, 12 and 23; Block 4134, Lot 1). Title for the street was vested in the City in 1946; however, the street was never built and the major length of it is used by the NYC Transit Maintenance Yard. The yard is owned and operated by the NYC Transit Authority. Access to the yard will not be affected by the street's elimination. Security

fences currently enclose the entirety of the maintenance yard to prevent unauthorized access. Primary access to the Yard is via elevated train tracks or via entrances on Eastchester Road and Waters Place for vehicles. It is unlikely that any development will occur on the portion of the subject street that lies within and is an integral part of the NYC Transit Maintenance Yard and transit system.

The Applicant's property, which is proposed to be developed with a new mixed-use building, includes Block 4134, Lot 1 and Block 4133, Lot 12. The portion of the Development Site that rests within the street to be eliminated is part or all of Block 4133, Lot 12 and Block 4134, Lot 1. The remaining properties within the street to be eliminated (neither part of the Development Site nor the NYC Transit Maintenance Yard) are improved upon as follows: Block 4133, Lot 8 is a cross-shaped lot that is currently used as a right-of-way, known as Cooper Avenue and Grant Street. The portion of Lot 8 that is within the bed of the street to be eliminated is a paved dead end stub that is used as street parking. Block 4133, Lot 10 is improved upon with a 13,230 square foot, two-story mixed use building that includes a catering establishment on the ground floor, and residential apartments above.

The Applicant plans to use the portion of the street to be eliminated that is within the Development Site as an access driveway to the Site. The requested elimination of this portion of Fink Avenue makes ample sense given current conditions for several reasons: (1) The portion of the street in question is mapped, but unbuilt; (2) Given the location of an MTA NYC Transit train yard located to the east of the Development Site, it is highly unlikely the City will ever exercise its ability to build this portion of the street; (3) An application was approved to demap a parallel portion of Ponton Avenue (one block north) to a similar extent, further indicating that this portion of the originally proposed street network will not be built out (ULURP Application No.: 110342MMX; CEQR No.: 11DCP136X); and (4) the area that would theoretically benefit from the building of this portion of Fink Avenue is already accessible from the private streets known as Grant Street and Cooper Street, which predate the mapping of Fink Avenue.

The proposed zoning change from M1-1 to R7A/C2-4 in other portions of the project area in addition to the Applicant Owned Projected Development Site 1 would serve to increase the permitted bulk in that area from an FAR of 1.0 for manufacturing and commercial uses and 2.4 for community facility uses to an FAR of 4.0 for all permitted residential and community facility uses, 2.0 for commercial uses, and 4.6 as a bonus for inclusionary housing. It would allow Use Group 6 commercial retail and office uses and also expand the scope of permitted commercial uses to include Use Groups 7B, 8, 9, and 14, which are not permitted in the nearby C1 commercial districts. It would prohibit the establishment of currently permitted uses in Use Groups 7A, 10, 11, 12, 13, 16, and 17. It would allow for the establishment of new uses in Use Groups 1-4 (residential and community facility use) in the project area. The increase in permitted bulk is appropriate given the City's policy of promoting increased development in close proximity to transit stops. The change is also appropriate given the lack of demand for manufacturing facilities in this area, which is very underdeveloped. Although little new development has occurred recently in the immediately surrounding area, the proposed zoning change is appropriate given recent rezoning actions described under the Description of the Surrounding Area above.

NO-ACTION SCENARIO

It is assumed that under the No-Action Scenario, existing conditions would continue on the Project Site and the Non-Applicant Owned Sites.

WITH-ACTION SCENARIO

This With-Action Scenario reflects the proposed Zoning for Quality and Affordability (ZQA) and Mandatory Inclusionary Housing (MIH) Text Amendments. As approved by HPD, 227 of the 228 units would be considered affordable with 65% or 148 units at 80% of AMI or less and 35% or 79 units at 100% AMI or less. One dwelling unit would be provided for the building superintendent and is not included in the affordability breakdown. For the purposes of providing a conservative analysis, the With-Action Scenario analyzes residential buildings with affordable housing on Projected Sites not owned by the Applicant, where future residential development would be feasible. Per MIH guidelines, 25% or 30% - Option 1 or Option 2 - will be mapped over the affected area. Under Option 1, 25% of residential floor area must be for affordable housing units for residents with incomes averaging 60% AMI (\$46,620 for a family of three) with at least 10% of the residential floor area affordable at or below 40% AMI. Under Option 2, 30% of residential floor area must be for affordable housing units for residents with incomes averaging 80% AMI (\$62,150 for a family of three). The exact percentage of affordable units has not yet been determined, and the exact income bands pertaining to AMI have not been set. CEQR evaluates affordability at 80% AMI and below, yet the MIH options above do not necessarily restrict affordable units to an income band at 80% AMI and below (they may be affordable at levels greater than 80% of AMI). Therefore, for conservative analysis purposes in this EAS, it is assumed that of the affordable units to be set aside, approximately 20% of those units in the remainder of the affected area will be affordable at 80% of AMI and below.

The With-Action RWCDs on Projected Development Site 1 would be the same as the proposed development described above and would include 228 dwelling units, 19,668 gsf of retail space, and 2,024 gsf of community facility space.

Up to 151 dwelling units (based on an average unit size of 871 gsf as proposed on the Applicant's Projected Development Site 1) and 29,061 gsf of commercial retail/office space would be developed on Projected Development Sites 2 through 6. All projected buildings on these Sites would be built to a height of 9-stories and 95'.

The existing structures and uses on all Projected Development Sites would be demolished and removed.

Projected Development Sites

Projected Development Site 1 (Block 4134, Lot 1) - The 46,360 sf lot would be developed with a new nine-story and cellar, 95'-0" tall mixed-use building totaling 261,660 gsf (including cellar area)/211,500 zsf and containing: 228 studio and one-, two-, and three-bedroom dwelling units within 198,683 gsf (excludes residential cellar area)/189,808 zsf on floors 1-9 based on an average size of 871 gsf per dwelling unit. For the purposes of MIH, 65% or 148 of the 228 units would be required to be affordable to those at 80% of AMI or less. However, as approved by HPD, 227 of the 228 units would be considered affordable with 65% or 148 units at 80% of AMI or less and 35% or 79 units at 100% AMI or less. One dwelling unit would be provided for the building superintendent and is not included in the

affordability breakdown. The development would have a total FAR of 4.56 and a residential FAR of 4.09.

- 19,668 gsf/zsf retail on the first/ground floor (FAR of 0.42).
- 2,024 gsf/zsf of community facility space on the first floor of the building (FAR of 0.04).
- 225 attended parking spaces in the cellar and on the first floor of the building.

Projected Development Site 2 (Block 4133, Lot 1) - The 2,874 sf lot would be developed with a 9-story, 95'-0" tall 13,616 gsf/13,220 zsf mixed use building containing 11,686 gsf/11,346 zsf of residential floor area for 13 dwelling units, 3 of which would be affordable at 80% AMI. The development would also include 1,930 gsf/1,874 zsf of ground floor commercial space. The development would have a total FAR of 4.6, a residential FAR of 3.95, and a commercial FAR of 0.65. Pursuant to ZR Section 25-251, parking would be required for 15% of the 3 income restricted units resulting in the need for 1 parking space. Pursuant to ZR Section 25-23, parking would be required for 50% of the 9 market rate units resulting in the need for 5 parking spaces. Pursuant to ZR Section 25-261, parking can be waived where fewer than 15 parking spaces are required. As only 6 parking spaces would be required, parking would be waived.

Projected Development Site 3 (Block 4133, Lot 2) - The 11,250 sf lot would be developed with a 9-story, 95'-0" tall 64,552 gsf/51,750 zsf mixed use building containing 42,745 gsf/41,500 zsf of residential floor area for 49 dwelling units, 10 of which would be affordable at 80% AMI. The development would also include 10,557 gsf/10,250 zsf of ground floor commercial space and 11,250 gsf for cellar level parking. The development would have a total FAR of 4.6, a residential FAR of 3.69, and a commercial FAR of 0.91. Pursuant to ZR Section 25-251, parking would be required for 15% of the 10 income restricted units resulting in the need for 2 parking spaces. Pursuant to ZR Section 25-23, parking would be required for 50% of the 34 market rate units resulting in the need for 17 parking spaces. 19 cellar level parking spaces would be provided on the Site.

Projected Development Site 4 (Block 4133, Lot 63 [p/o]) - The 11,663 sf lot would be developed with a 9-story, 95'-0" tall 66,922 gsf/53,650 zsf mixed use building containing 45,989 gsf/44,650 zsf of residential floor area for 53 dwelling units, 11 of which would be affordable at 80% AMI. The development would also include 9,270 gsf/9,000 zsf of ground floor commercial space and 11,663 gsf for cellar level parking. The development would have a total FAR of 4.6, a residential FAR of 3.83, and a commercial FAR of 0.77. Pursuant to ZR Section 25-251, parking would be required for 15% of the 11 income restricted units resulting in the need for 2 parking spaces. Pursuant to ZR Section 25-23, parking would be required for 50% of the 37 market rate units resulting in the need for 19 parking spaces. 21 cellar level parking spaces would be provided on the Site.

Projected Development Site 5 (Block 4133, Lot 10) - The 4,950 sf lot would be developed with a 9-story, 95'-0" tall 23,453 gsf/22,770 zsf mixed use building containing 19,385 gsf/18,820 zsf of residential floor area for 22 dwelling units, 5 of which would be affordable at 80% AMI. The development would also include 4,068 gsf/3,950 zsf of ground floor commercial space. The development would have a total FAR of 4.6, a residential FAR of 3.80, and a commercial FAR of 0.80. Pursuant to ZR Section 25-251, parking would be required for 15% of the 5 income restricted units resulting in the need for 1 parking space. Pursuant to ZR Section 25-23, parking would be required for 50% of the 15 market rate units

resulting in the need for 8 parking spaces. Pursuant to ZR Section 25-261, parking can be waived where fewer than 15 parking spaces are required. As only 9 parking spaces would be required, parking would be waived.

Projected Development Site 6 (Block 4133, Lots 61 & 62) – The 4,142 sf combined lot would be developed with a 9-story, 95'-0" tall 19,625 gsf/19,053 zsf mixed use building containing 16,389 gsf/15,911 zsf of residential floor area for 19 dwelling units, 4 of which would be affordable at 80% AMI. The development would also include 3,236 gsf/3,142 zsf of ground floor commercial space. The development would have a total FAR of 4.6, a residential FAR of 3.84, and a commercial FAR of 0.76. Pursuant to ZR Section 25-251, parking would be required for 15% of the 4 income restricted units resulting in the need for 1 parking space. Pursuant to ZR Section 25-23, parking would be required for 50% of the 13 market rate units resulting in the need for 7 parking spaces. Pursuant to ZR Section 25-261, parking can be waived where fewer than 15 parking spaces are required. As only 8 parking spaces would be required, parking would be waived.

Other Sites

Other Site 1 (Block 4133, Lot 8) - The Fink Avenue portion of the 18,022 sf lot would be demapped and would not be developed. The Grant and Cooper Avenue portions of this lot would continue to be used as a driveway access to the adjoining parcels.

Other Site 2 (Block 4134, Lot 14 [partial]) – This Site consists of 50% of the to be demapped portion of Ponton Avenue (7,687 sf) and would be improved with parking. Based on the Ponton Avenue Demapping EAS (11DCP136X), the demapped portion of Ponton Avenue would be used for accessory parking and vehicle storage. Up to 12 accessory parking spaces would be provided. No new construction would take place on this portion of Ponton Avenue beyond paving, fencing, lighting, and additional security features.

INCREMENT BETWEEN NO-ACTION AND WITH-ACTION SCENARIOS

Under the With-Action Scenario for the project build year of 2029, the six Projected Development Sites would be developed with six new buildings containing a total of 449,828 gsf of floor area including 384 dwelling units (based on an average size of 871 gsf per dwelling unit excluding cellar space), 260 of which would be affordable units, 48,729 gsf of commercial retail/office space, 2,024 gsf of community facility space (day care center and medical offices), and 265 accessory parking spaces. The existing 39,704 gsf of office and retail space, 6,775 gsf of storage and automobile related floor area (automobile repair and storage), 4,410 gsf of residential floor area for 4 market rate dwelling units, one vacant 766 gsf dwelling unit, and parking areas would be removed. This would result in an increase of 398,173 gsf of total floor area and would include the addition of 380 dwelling units, 260 of which would be affordable units, 9,025 gsf of commercial retail/office space, 2,024 gsf of community facility space (day care center and medical offices), and 265 accessory parking spaces. Other Site 1 would be partially demapped.

DESCRIPTION OF EXISTING AND PROPOSED CONDITIONS

The information requested in this table applies to the directly affected area. The directly affected area consists of the project site and the area subject to any change in regulatory control. The increment is the difference between the No-Action and the With-Action conditions.

	EXISTING CONDITION	NO-ACTION CONDITION	WITH-ACTION CONDITION	INCREMENT
LAND USE				
Residential	<input checked="" type="checkbox"/> YES <input type="checkbox"/> NO	<input checked="" type="checkbox"/> YES <input type="checkbox"/> NO	<input checked="" type="checkbox"/> YES <input type="checkbox"/> NO	
If "yes," specify the following:				
Describe type of residential structures	single- & multi-family	single- & multi-family	multi-family	- single-family
No. of dwelling units	4	4	384	+ 380
No. of low- to moderate-income units	0	0	260	+ 260
Gross floor area (sq. ft.)	4,410	4,410	399,075	+ 394,665
Commercial	<input checked="" type="checkbox"/> YES <input type="checkbox"/> NO	<input checked="" type="checkbox"/> YES <input type="checkbox"/> NO	<input checked="" type="checkbox"/> YES <input type="checkbox"/> NO	
If "yes," specify the following:				
Describe type (retail, office, other)	retail,office	retail,office	retail,office	
Gross floor area (sq. ft.)	39,704	39,704	48,729	+ 9,025
Manufacturing/Industrial	<input checked="" type="checkbox"/> YES <input type="checkbox"/> NO	<input checked="" type="checkbox"/> YES <input type="checkbox"/> NO	<input type="checkbox"/> YES <input checked="" type="checkbox"/> NO	
If "yes," specify the following:				
Type of use	vehicle related & storage	vehicle related & storage		- vehicle related & storage
Gross floor area (sq. ft.)	6,775	6,775		- 6,775
Open storage area (sq. ft.)	unknown	unknown		
If any unenclosed activities, specify:				
Community Facility	<input type="checkbox"/> YES <input checked="" type="checkbox"/> NO	<input type="checkbox"/> YES <input checked="" type="checkbox"/> NO	<input checked="" type="checkbox"/> YES <input type="checkbox"/> NO	
If "yes," specify the following:				
Type			day care, medical offices	+ day care, medical offices
Gross floor area (sq. ft.)			2,024	+ 2,024
Vacant Land	<input checked="" type="checkbox"/> YES <input type="checkbox"/> NO	<input checked="" type="checkbox"/> YES <input type="checkbox"/> NO	<input type="checkbox"/> YES <input checked="" type="checkbox"/> NO	
If "yes," describe:	street rights-of-way	street rights-of-way		- street rights-of-way
Publicly Accessible Open Space	<input type="checkbox"/> YES <input checked="" type="checkbox"/> NO	<input type="checkbox"/> YES <input checked="" type="checkbox"/> NO	<input type="checkbox"/> YES <input checked="" type="checkbox"/> NO	
If "yes," specify type (mapped City, State, or Federal parkland, wetland—mapped or otherwise known, other):				
Other Land Uses	<input checked="" type="checkbox"/> YES <input type="checkbox"/> NO	<input checked="" type="checkbox"/> YES <input type="checkbox"/> NO	<input type="checkbox"/> YES <input checked="" type="checkbox"/> NO	
If "yes," describe:	766 gsf abandoned dwelling unit	766 gsf abandoned dwelling unit		- 766 gsf abandoned dwelling unit
PARKING				
Garages	<input type="checkbox"/> YES <input checked="" type="checkbox"/> NO	<input type="checkbox"/> YES <input checked="" type="checkbox"/> NO	<input checked="" type="checkbox"/> YES <input type="checkbox"/> NO	
If "yes," specify the following:				
No. of public spaces			0	
No. of accessory spaces			265	+ 265
Operating hours			24/7	
Attended or non-attended			225 attended/40 unattended	+ 225 attended/40 unattended
Lots	<input checked="" type="checkbox"/> YES <input type="checkbox"/> NO	<input checked="" type="checkbox"/> YES <input type="checkbox"/> NO	<input type="checkbox"/> YES <input checked="" type="checkbox"/> NO	
If "yes," specify the following:				
No. of public spaces	0	0		
No. of accessory spaces	unknown	unknown		- unknown
Operating hours	unknown	unknown		
Other (includes street parking)	<input type="checkbox"/> YES <input checked="" type="checkbox"/> NO	<input type="checkbox"/> YES <input checked="" type="checkbox"/> NO	<input type="checkbox"/> YES <input checked="" type="checkbox"/> NO	
If "yes," describe:				
POPULATION				

	EXISTING CONDITION	NO-ACTION CONDITION	WITH-ACTION CONDITION	INCREMENT
Residents	<input checked="" type="checkbox"/> YES <input type="checkbox"/> NO	<input checked="" type="checkbox"/> YES <input type="checkbox"/> NO	<input checked="" type="checkbox"/> YES <input type="checkbox"/> NO	
If "yes," specify number:	11	11	1,102	+ 1,091
Briefly explain how the number of residents was calculated:	Based on 2010 Census data, the average household size is 2.87 persons per dwelling unit in the Census Tracts located within 1/4-mile of the Rezoning Area (tracts 96, 194, 200, 202, 264, and 284).			
Businesses	<input checked="" type="checkbox"/> YES <input type="checkbox"/> NO	<input checked="" type="checkbox"/> YES <input type="checkbox"/> NO	<input checked="" type="checkbox"/> YES <input type="checkbox"/> NO	
If "yes," specify the following:				
No. and type	6 auto repair/storage businesses; 3 office uses; 3 retail uses	6 auto repair/storage businesses; 3 office uses; 3 retail uses	5 retail stores; medical office space	- 6 auto repair/storage businesses; -2 office uses; +2 retail uses
No. and type of workers by business	6 auto repair/storage workers; 93 office & retail workers	6 auto repair/storage workers; 93 office & retail workers	146 retail employees, 8 medical office workers, 15 residential employees	- 6 auto repair/storage workers; + 61 office & retail workers; + 15 residential employees
No. and type of non-residents who are not workers	100 customers/visitors per day	100 customers/visitors per day	175 customers/visitors per day	+ 75 customers/visitors per day
Briefly explain how the number of businesses was calculated:	Under existing and no-action conditions, the number of businesses is based on the current existing businesses; under with-action conditions, the number of businesses is based on the proposed and projected development.			
Other (students, visitors, concert-goers, etc.)	<input type="checkbox"/> YES <input checked="" type="checkbox"/> NO	<input type="checkbox"/> YES <input checked="" type="checkbox"/> NO	<input type="checkbox"/> YES <input checked="" type="checkbox"/> NO	
If any, specify type and number:				
Briefly explain how the number was calculated:				
ZONING				
Zoning classification	M1-1	M1-1	R7A/C2-4	- M1-1; + R7A/C2-4
Maximum amount of floor area that can be developed	99,281 M or C; 238,274 CF	99,281 M or C; 238,274 CF	456,692 R; 198,562 C; 397,124 CF	+456,692 R; +99,281 C; +158,850 CF
Predominant land use and zoning classifications within land use study area(s) or a 400 ft. radius of proposed project	Commercial, industrial, transportation, parking, vacant; R6, C1-2, M1-1	Commercial, industrial, transportation, parking, vacant; R6, C1-2, M1-1	Residential, commercial, industrial, community facility, transportation, parking, vacant; R6, R7-2/C2-4, C1-2, M1-1	+ residential, community facility; + R7-2/C2-4
Attach any additional information that may be needed to describe the project.				
If your project involves changes that affect one or more sites not associated with a specific development, it is generally appropriate to include total development projections in the above table and attach separate tables outlining the reasonable development scenarios for each site.				

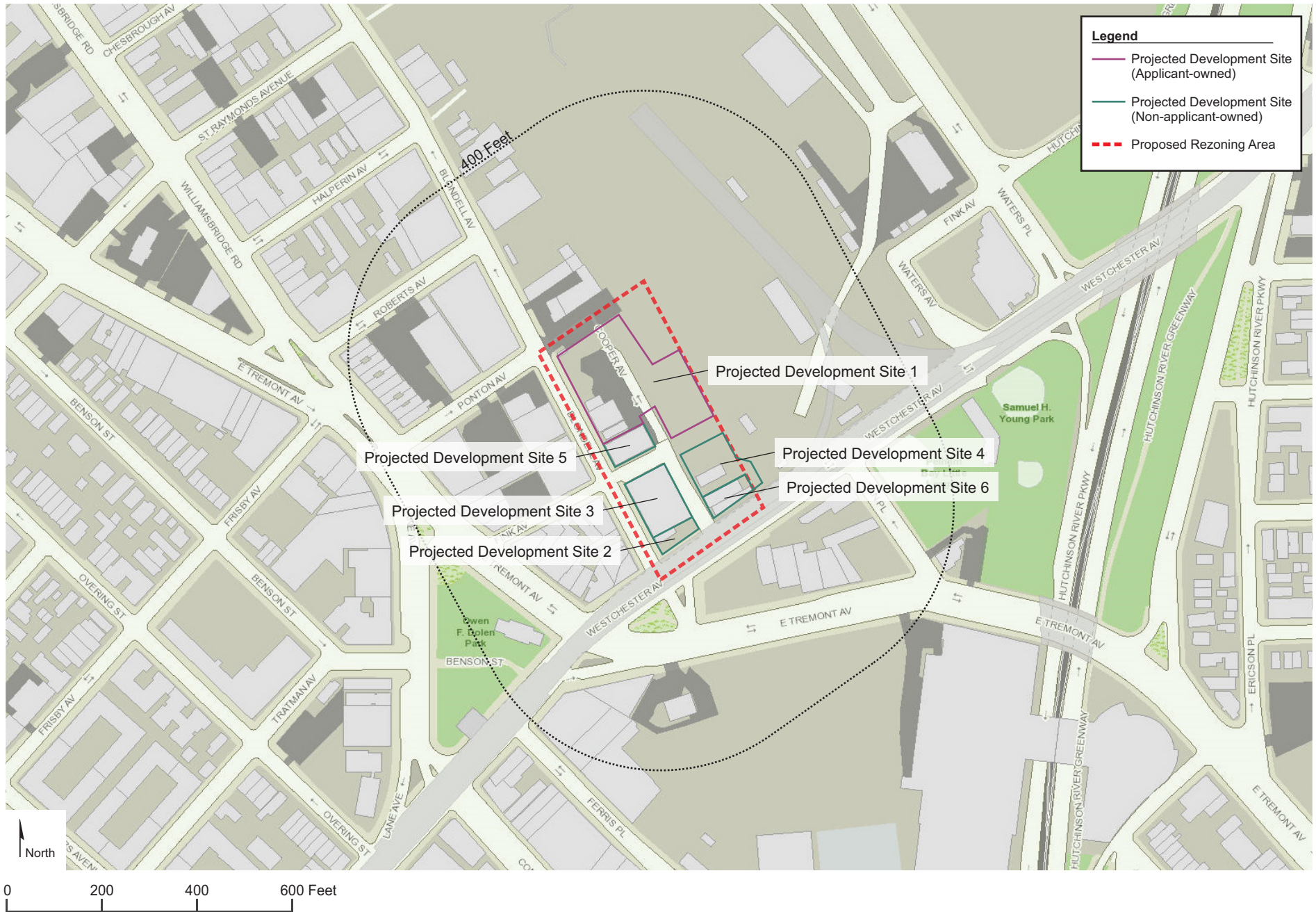



1. View of the Site facing southeast from Blondell Avenue.



2. View of the Site facing east from Blondell Avenue.



3. View of the Site facing northeast from Blondell Avenue.





4. View of Ponton Avenue facing northeast toward Blondell Avenue (Site at right).



5. View of Ponton Avenue facing southwest from the Site.



6. View of Blondell Avenue facing southeast from Ponton Avenue (Site at left).





7. View of the sidewalk along the east side of Blondell Avenue facing southeast (Site at left).



8. View of the west side of Blondell Avenue facing northwest from the Site.



9. View of the west side of Blondell Avenue facing southwest from the Site.





10. View of the east side of Blondell Avenue facing southeast toward Fink Avenue.



11. View of Fink Avenue facing northeast toward Blondell Avenue.



12. View of the sidewalk along the east side of Blondell Avenue facing northwest (Site ahead, at right)





13. View of Fink Avenue facing southwest from Blondell Avenue.



14. View of Fink Avenue facing southwest from Cooper Avenue.



15. View of the north side of Fink Avenue facing northwest from Cooper Avenue.

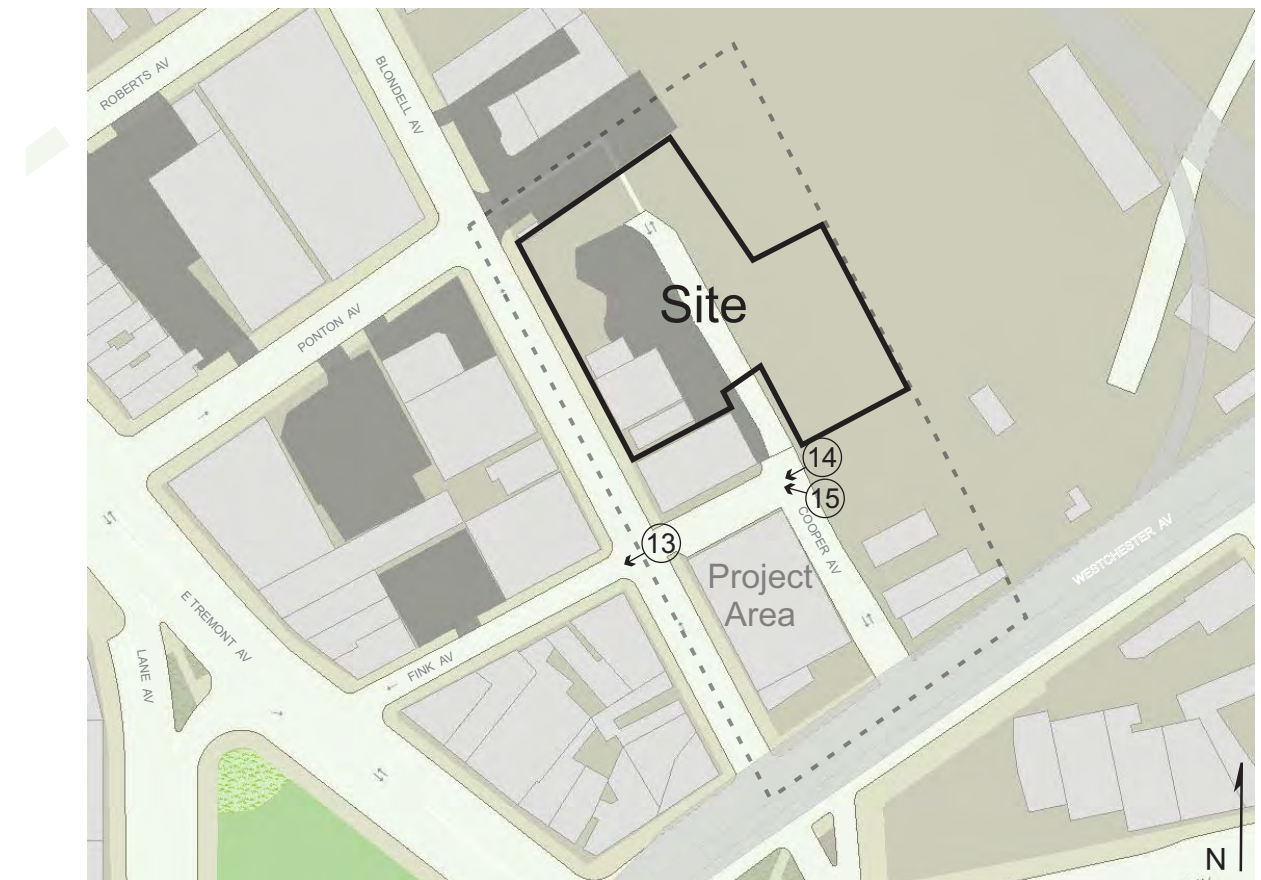



16. View of the south side of Fink Avenue facing southwest from Cooper Avenue.



17. View of Cooper Avenue facing southeast toward Fink Avenue from the Site.



18. View of the Site facing northwest from the intersection of Cooper Avenue and Fink Avenue.





19. View of the east side of Cooper Avenue between Fink Avenue and Westchester Avenue facing northeast.



20. View of the east side of Cooper Avenue facing northeast from Westchester Avenue.



21. View of Cooper Avenue facing northwest from Westchester Avenue.





22. View of the north side of Westchester Avenue facing northeast.



23. View of the sidewalk along the north side of Westchester Avenue facing west.



24. View of the sidewalk along the north side of Westchester Avenue facing east.





25. View of Westchester Avenue facing west toward Cooper Avenue.



26. View of the south side of Westchester Avenue facing southeast from Cooper Avenue.



27. View of Westchester Avenue facing east from Blondell Avenue.





28. View of the north side of Westchester Avenue facing northwest toward Blondell Avenue.



29. View of the south side of Westchester Avenue facing south from Blondell Avenue.



30. View of Blondell Avenue facing northwest from Westchester Avenue (Site far ahead, at right).





31. View of the sidewalk along the east side of Blondell Avenue facing northwest from Westchester Avenue.



32. View of the sidewalk along the east side of Blondell Avenue facing southeast from Fink Avenue.



33. View of the east side of Blondell Avenue between Fink Avenue and Westchester Avenue facing northeast (Site at far left).





34. View of the east side of Blondell Avenue between Fink Avenue and Westchester Avenue facing southeast.



35. View of the west side of Blondell Avenue between Fink Avenue and Westchester Avenue facing northwest.

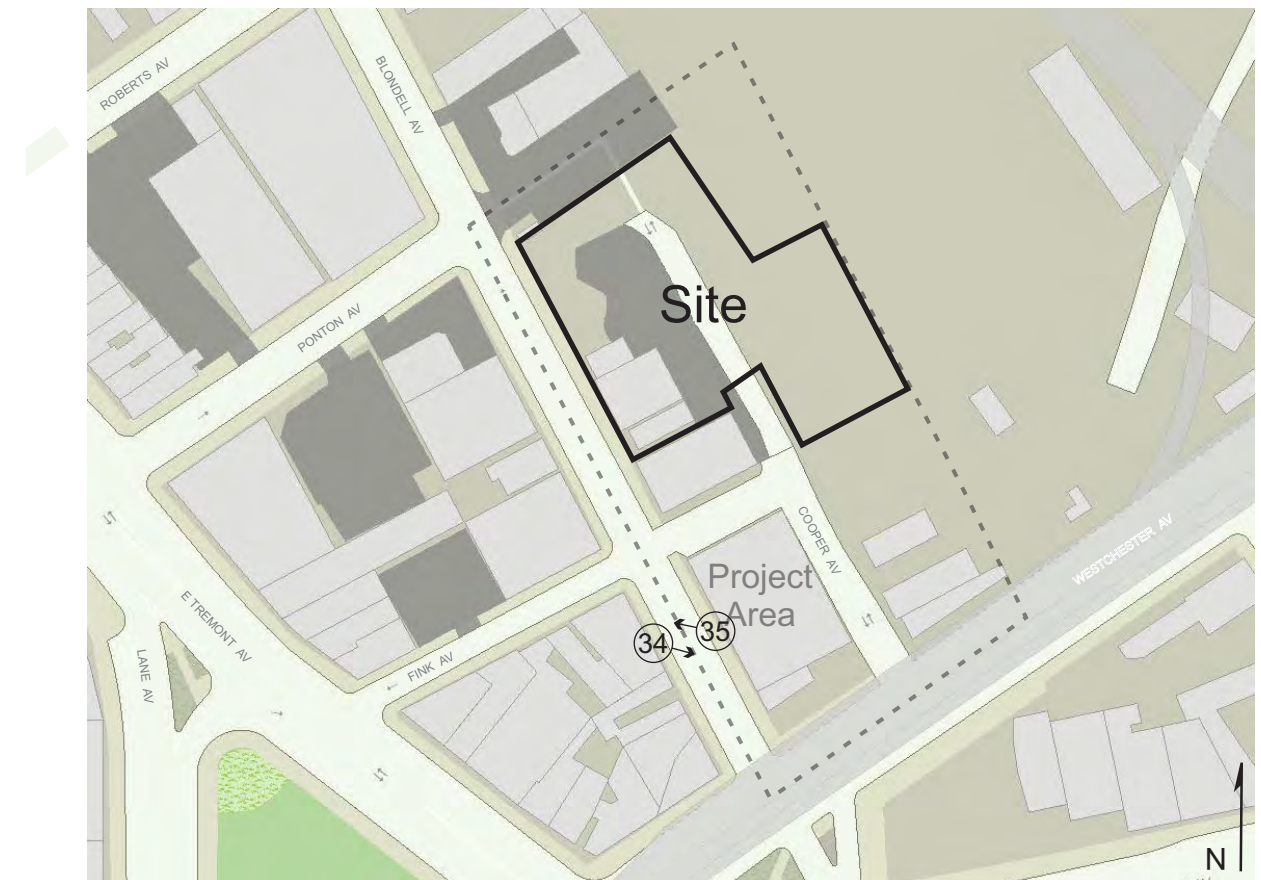

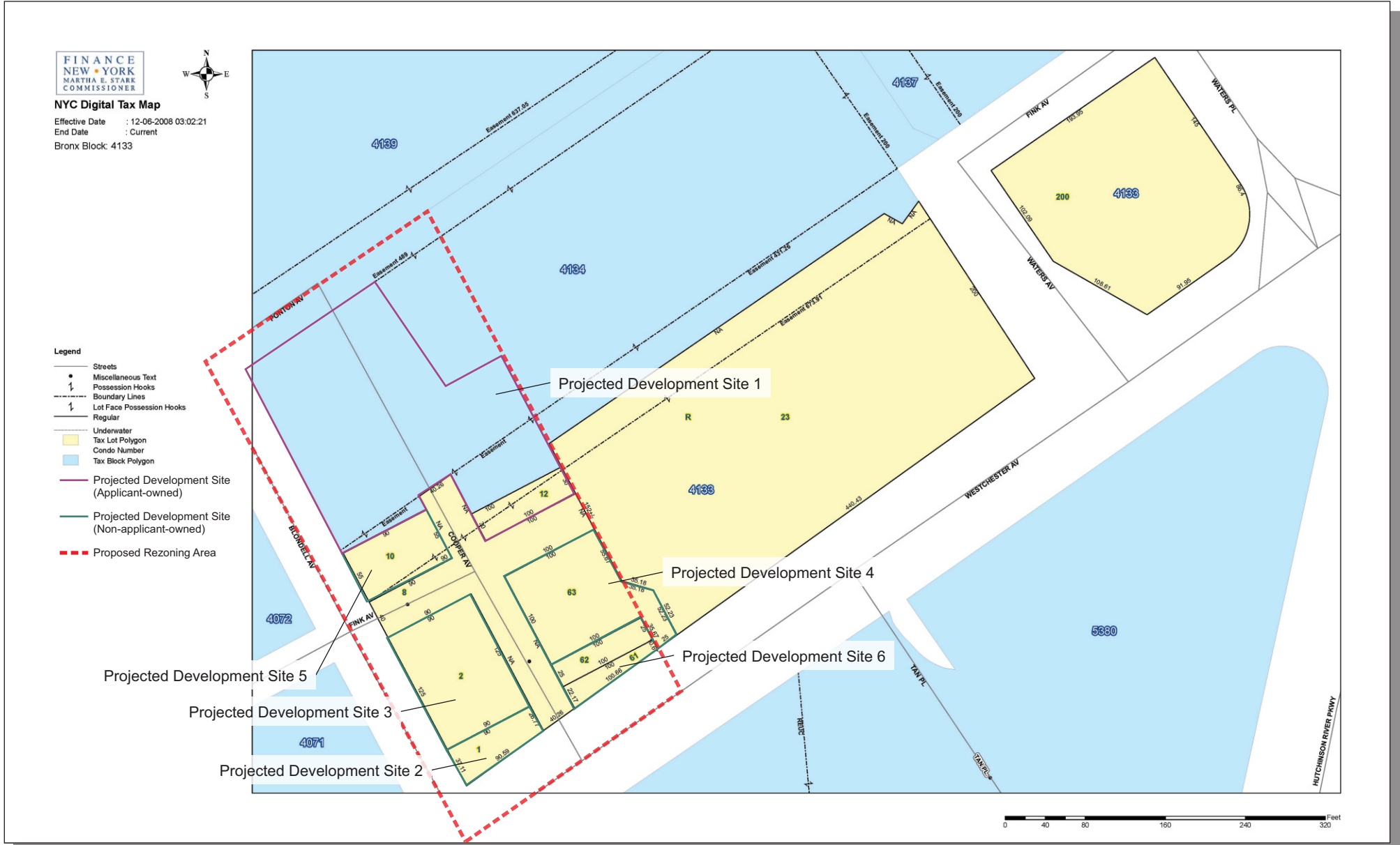

FINANCE
NEW YORK
MARTHA E. STARR
COMMISSIONER



NYC Digital Tax Map

Effective Date : 12-06-2008 03:02:37
End Date : Current
Bronx Block: 4134

Legend

- Streets
- Miscellaneous Text
- Possession Hooks
- Boundary Lines
- Lot Face Possession Hooks
- Regular
- Underwater
- Tax Lot Polygon
- Condo Number
- Tax Block Polygon
- Projected Development Site (Applicant-owned)
- Projected Development Site (Non-applicant-owned)
- Proposed Rezoning Area

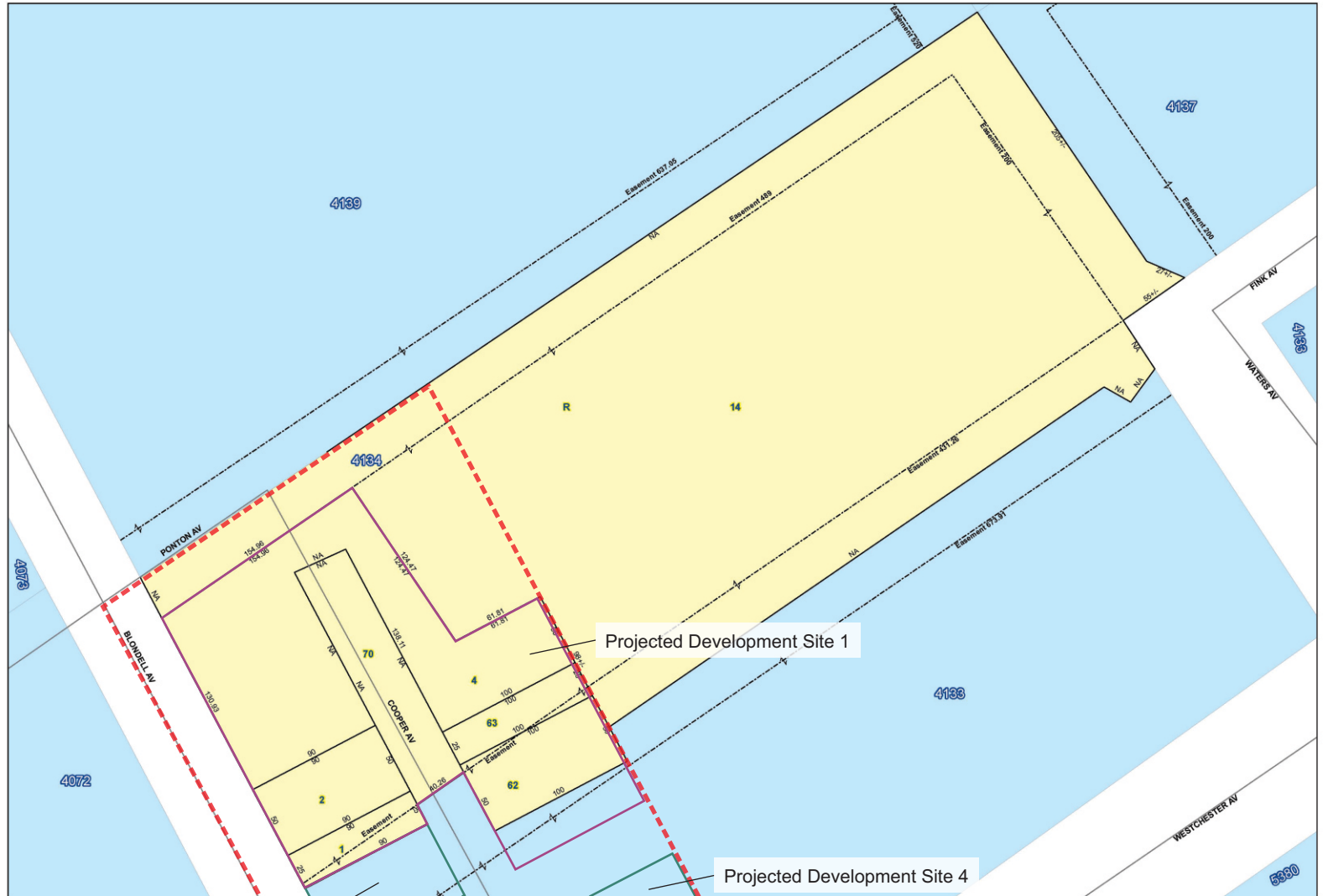



NYC Digital Tax Map

Effective Date : 12-06-2008 03:02:21
End Date : Current
Bronx Block: 4133

Legend

- Streets
- Miscellaneous Text
- ↓ Possession Hooks
- - - Boundary Lines
- ↓ Lot Face Possession Hooks
- Regular
- Underwater
- Yellow Tax Lot Polygon
- Blue Tax Block Polygon

- Red dashed line Development Site
- Black dotted line Area Proposed to be Rezoned
- Hatched area Proposed Demapping
- Red dotted line 400 foot Radius

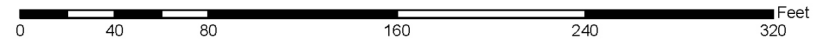
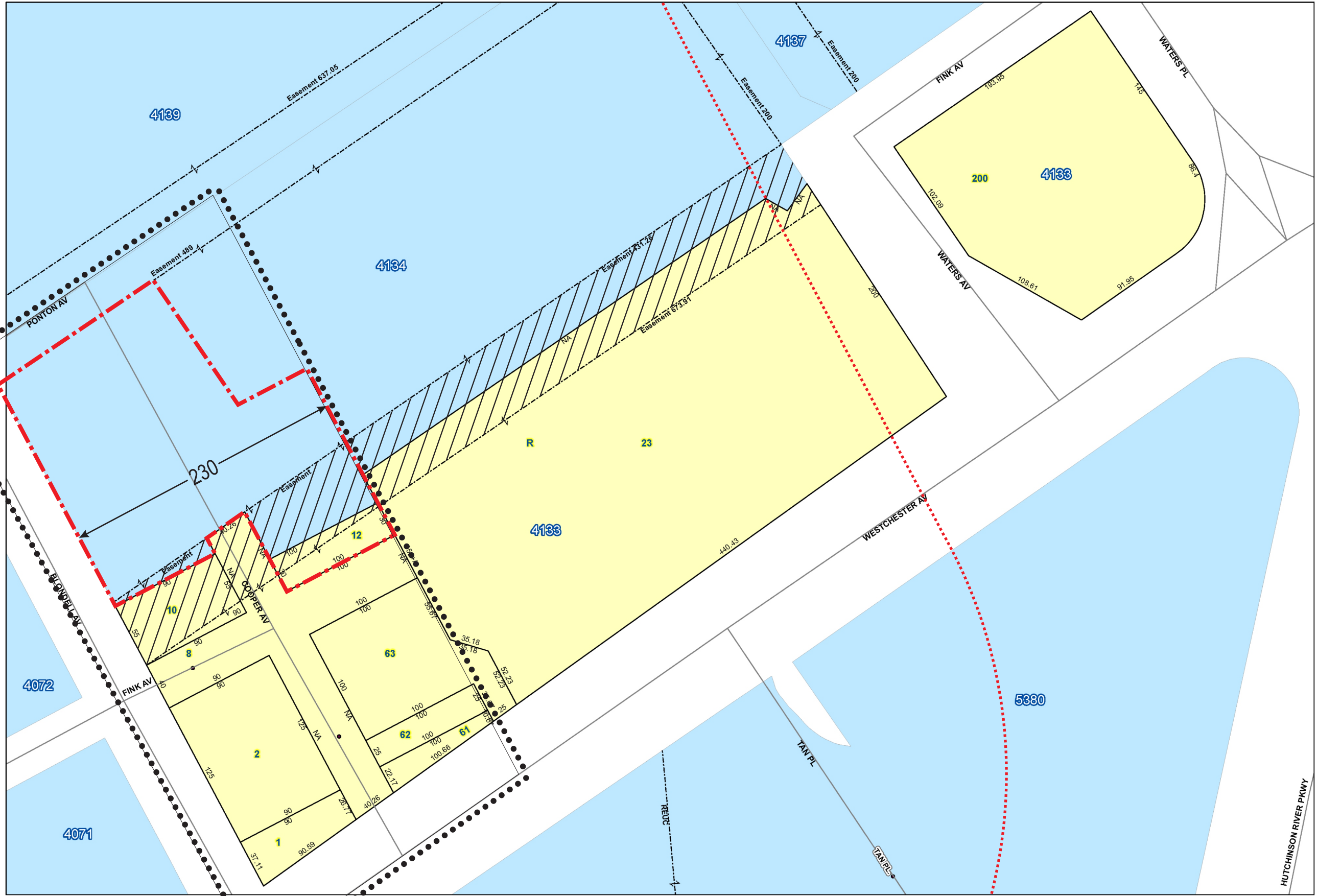

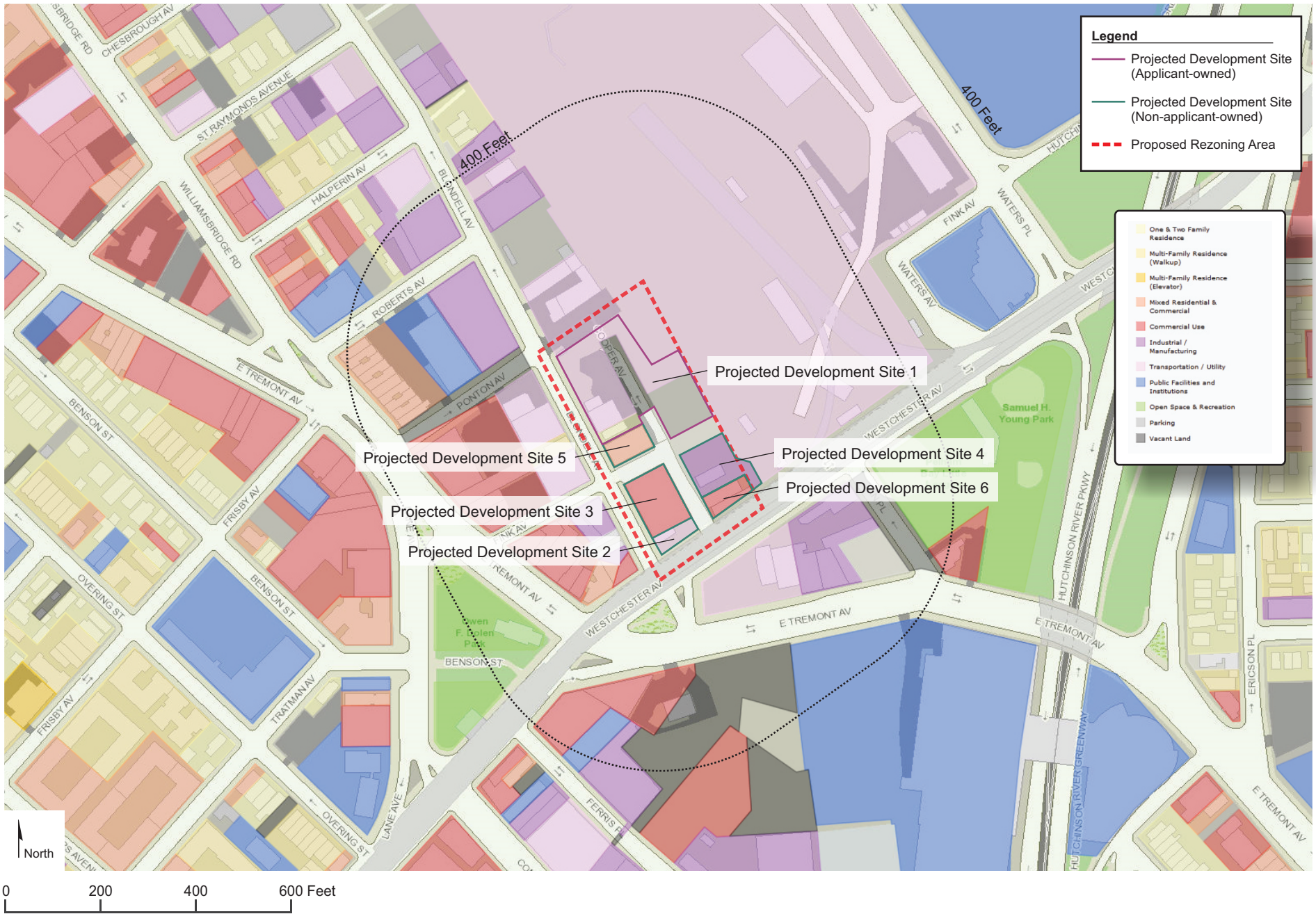

Site

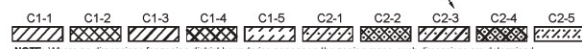
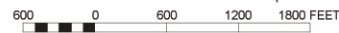
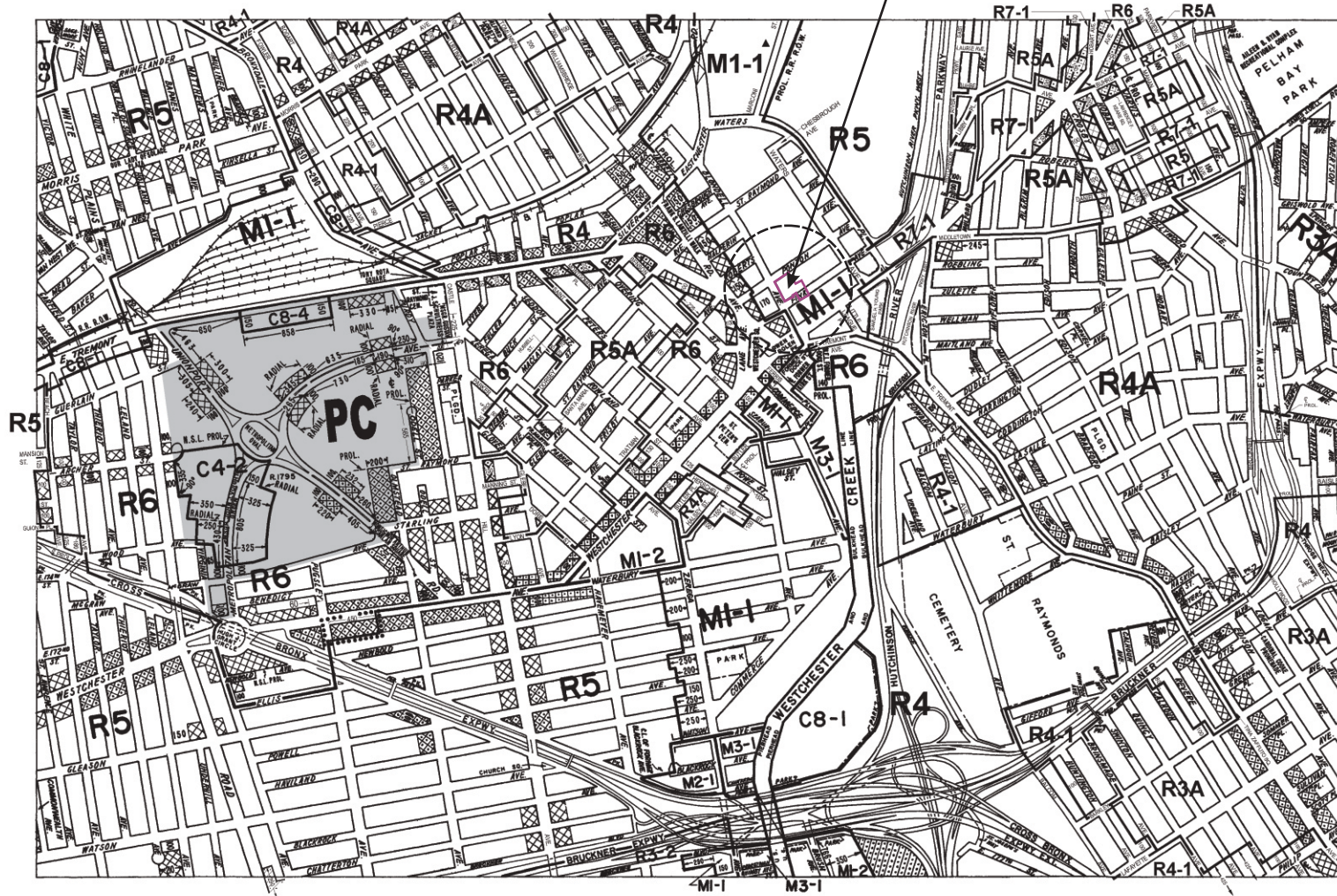

NOTE: Where no dimensions for zoning district boundaries appear on the zoning maps, such dimensions are determined in Article VII, Chapter 6 (Location of District Boundaries) of the Zoning Resolution.

ZONING MAP

THE NEW YORK CITY PLANNING COMMISSION

Major Zoning Classifications:
The number(s) and/or letter(s) that follows an R, C or M District designation indicates use, bulk and other controls as described in the text of the Zoning Resolution.

- R – RESIDENTIAL DISTRICT
- C – COMMERCIAL DISTRICT
- M – MANUFACTURING DISTRICT
- SPECIAL PURPOSE DISTRICT
The letter(s) within the shaded area designates the special purpose district as described in the text of the Zoning Resolution.
- AREA(S) REZONED

Effective Date(s) of Rezoning:
06-12-2008 C 050172 ZMX

Special Requirements:
For a list of lots subject to CEQR environmental requirements, see APPENDIX C.
For a list of lots subject to "D" restrictive declarations, see APPENDIX D.
For Inclusionary Housing designated areas on this map, see APPENDIX F.

CITY MAP CHANGE(S):
▲ 12-18-2010 C 080197 MMX

MAP KEY

3c	4a	4c
3d	4b	4d
6c	7a	7c

© Copyrighted by the City of New York

NOTE: Zoning information as shown on this map is subject to change. For the most up-to-date zoning information for this map, visit the Zoning section of the Department of City Planning website: www.nyc.gov/planning or contact the Zoning Information Desk at (212) 720-5291.

ZONING MAP 4b





- Area proposed to be rezoned

Zoning Change Map

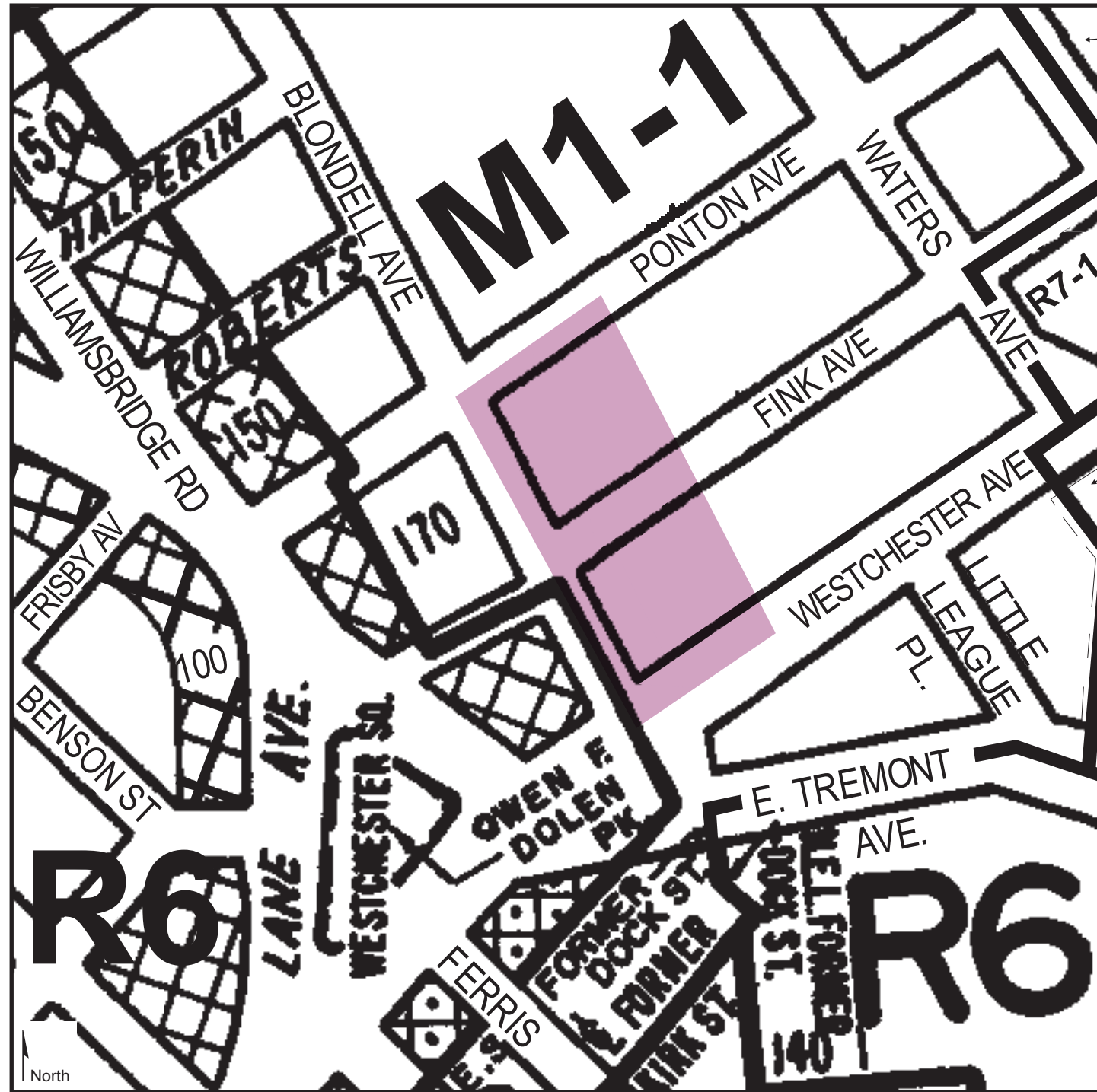

Current Zoning Map (4b)

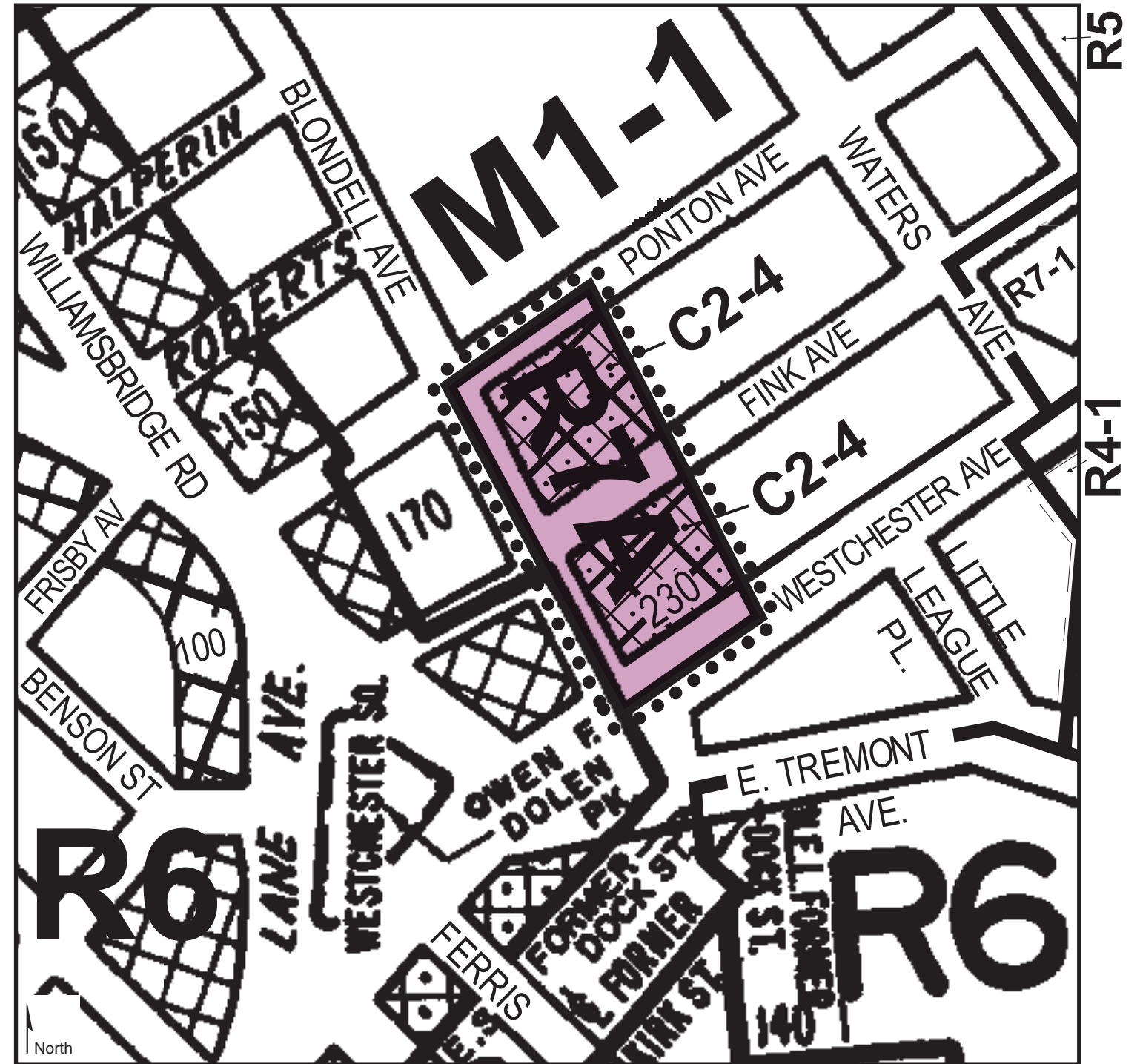

Proposed Zoning Map (4b) - Project Area is outlined with dotted lines

Rezoning from M1-1 to R7A/C2-4

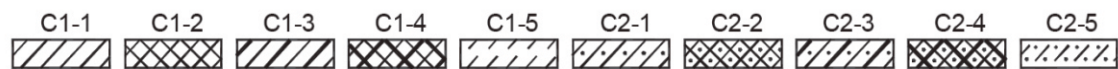

**1346 Blondell Avenue
Community District 11, The Bronx
12/12/17
Zoning Map 4b**

Matter underlined is new, to be added;
Matter ~~struck out~~ is to be deleted;
Matter within # # is defined in Section 12-10;
* * * indicates where unchanged text appears in the Zoning Resolution
* * *

**APPENDIX F
Inclusionary Housing Designated Areas and Mandatory Inclusionary Housing Areas**

The Bronx

The Bronx Community District 11

* * *
* * *
* * *



 Mandatory Inclusionary Housing Area (see Section 23-154(d)(3))

Area 2 — [date of adoption] — MIH Program Option 1 and Option 2

Portion of Community District 11, The Bronx

* * *

FOR ILLUSTRATIVE
PURPOSE ONLY

1340
BLONDELL
AVE.
BRONX, NY

AUFGANG
ARCHITECTS

PROGRESS SET
09.24.18

PRELIMINARY
3D RENDERING

T-001.00

PROPOSED ZONE: R7A/C2-4
EX. ZONE: M1-1 09.24.18
BLOCK: 4133/4134 LOT: 1,2,4,62
63,70,12

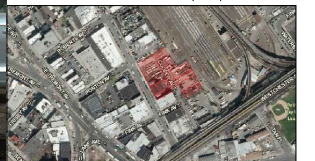

FOR ILLUSTRATIVE
PURPOSE ONLY

AUFGANG
ARCHITECTS

PROGRESS SET
09.24.18

ZONING LOT
SITE PLAN

C-100.00

PROPOSED ZONE: R7A/C2-4
EX. ZONE: M1-1 09.24.18
BLOCK: 4133/4134 LOT: 1,2,4,62
63.70.12

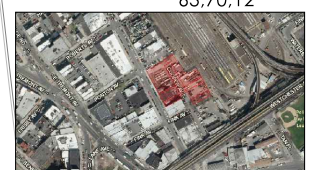

LEGEND:

← TRAFFIC DIRECTIONS	EXISTING CURB CUTS
— PROPERTY LINE	EXISTING TREE PIT
— MERGED ZONING LOT	⊕ FIRE HYDRANT
⊕ NEW STREET TREE	⊕ SIGNS
⊕ EXISTING STREET TREE	⊕ UTILITY LIGHT POLE
■ PROPOSED DEVELOPMENT	⊕ MANHOLES
▭ EXISTING BUILDINGS	■ GRATES

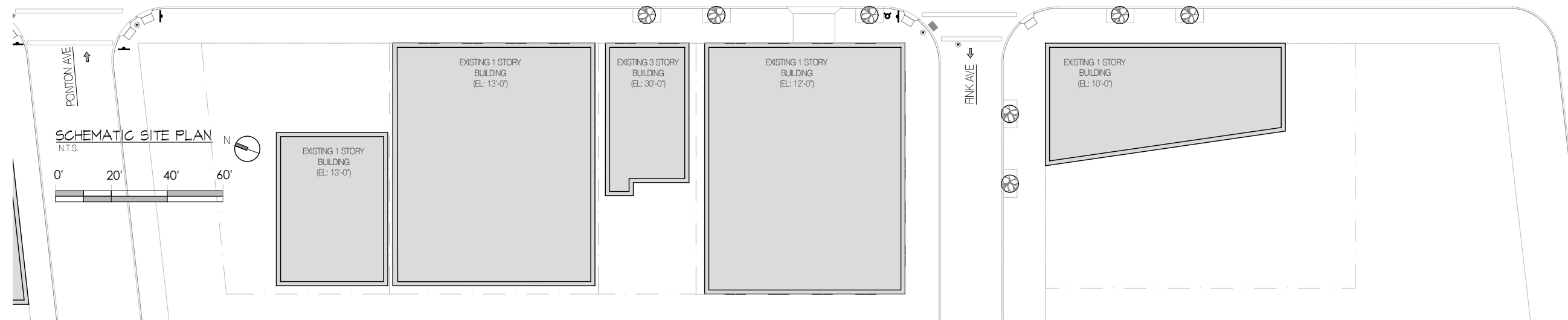

FOR ILLUSTRATIVE
PURPOSE ONLY

1340
BLONDELL
AVE.
BRONX, NY

AUFGANG
ARCHITECTS

PROGRESS SET
09.24.18

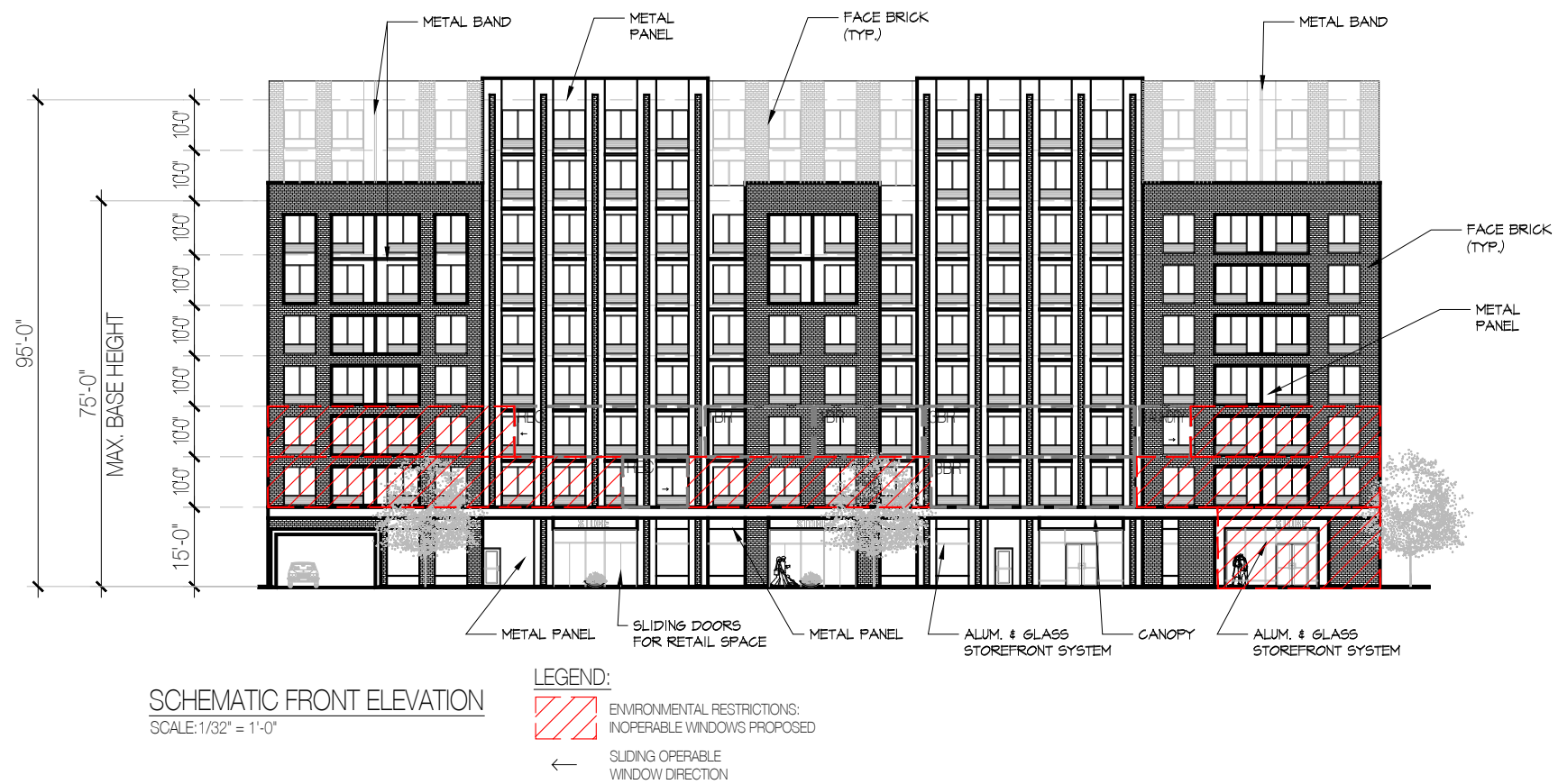

SCHMATIC
ELEVATION

A-106.00

PROPOSED ZONE: R7A/C2-4
EX. ZONE: M1-1 09.24.18
BLOCK: 4133/4134 LOT: 1,2,4,62
63,70,12



FOR ILLUSTRATIVE
PURPOSE ONLY

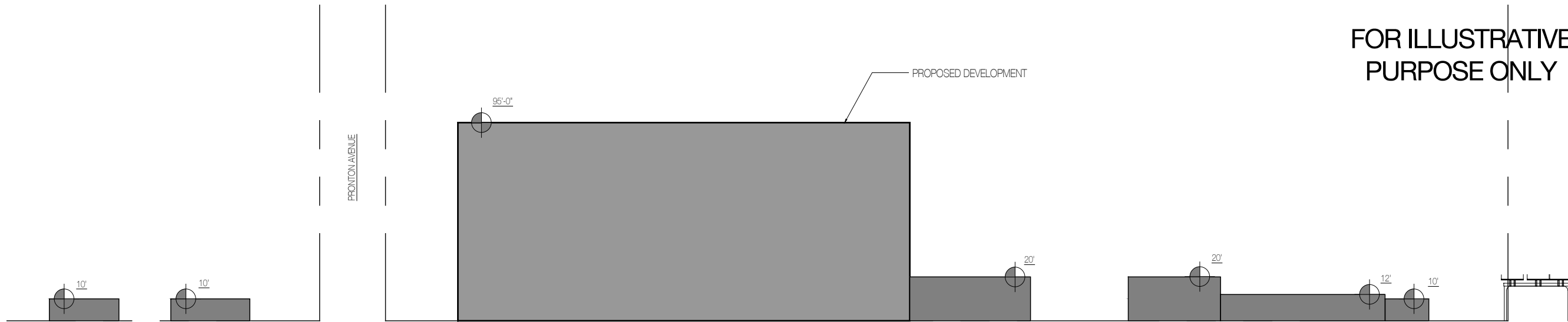

STREETSCAPE ELEVATION A-A
NOT TO SCALE

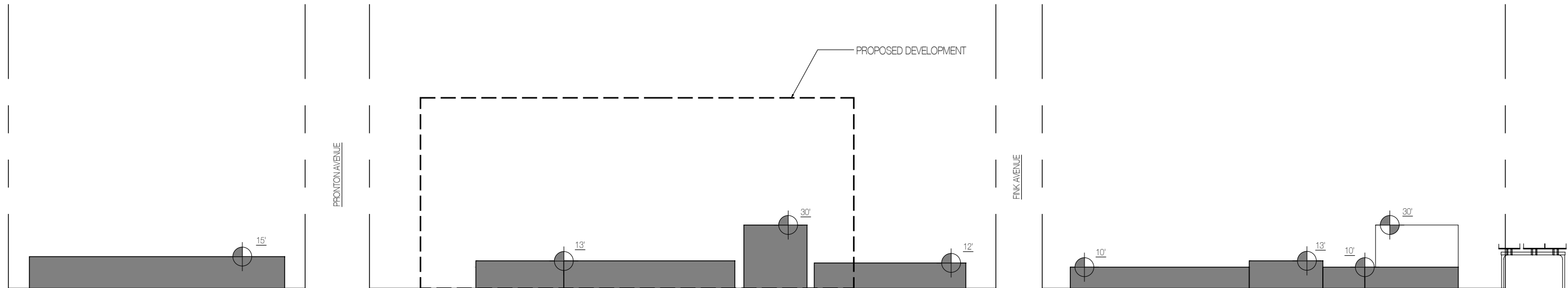

STREETSCAPE ELEVATION B-B
NOT TO SCALE

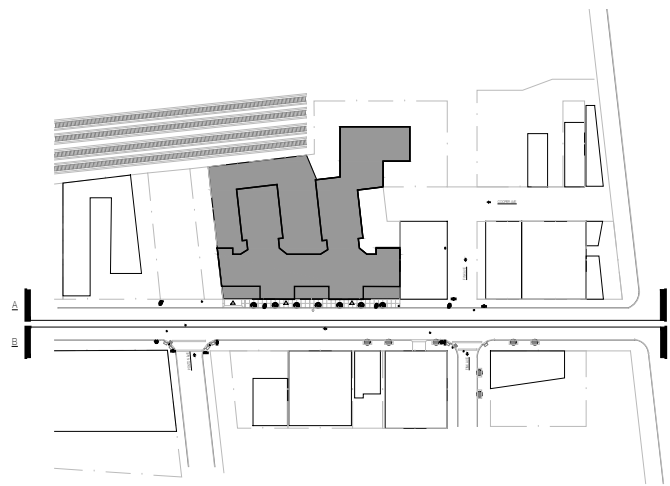

KEY PLAN
NOT TO SCALE

- LEGEND:**
- PROPOSED DEVELOPMENT
 - STREETS
 - PROPOSED DEVELOPMENT BEHIND
 - BUILDING HEIGHTS
 - EXISTING BUILDINGS ON ELEVATION STREETSCAPE
 - EXISTING BUILDINGS BEYOND STREET WALL

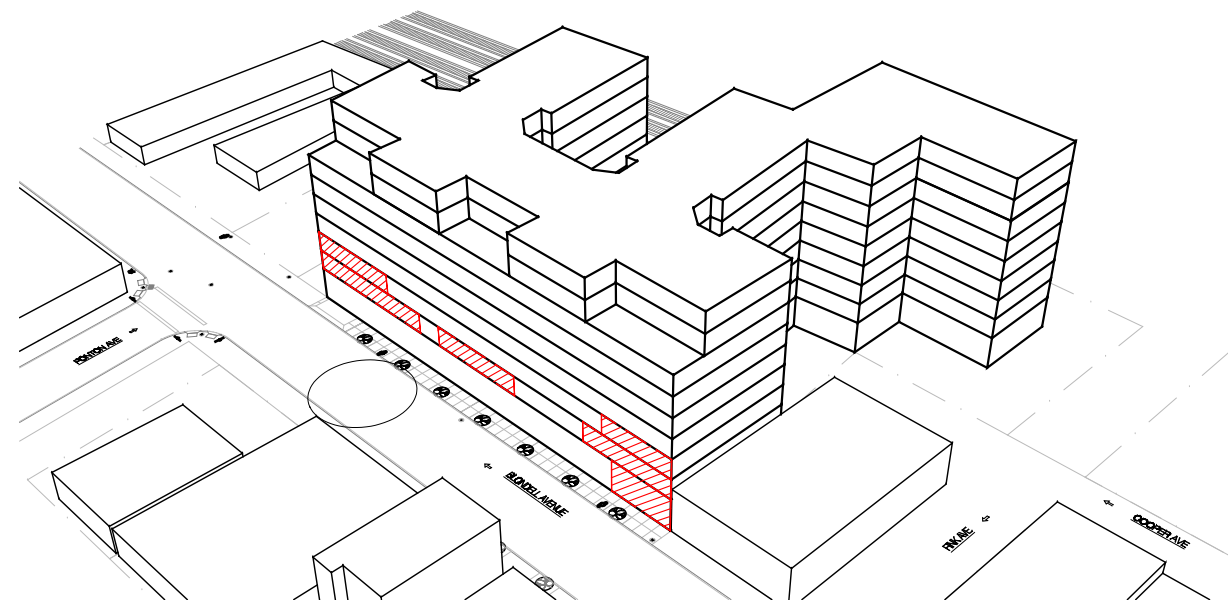

3D MASSING
NOT TO SCALE

PROGRESS SET
09.24.18

NEIGHBORHOOD
CHARACTER
DIAGRAM

A-107.00

PROPOSED ZONE: R7A/C2-4
EX. ZONE: M1-1 09.24.18
BLOCK: 4133/4134 LOT: 1,2,4,62
63.70.12

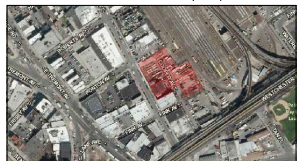

ENVIRONMENTAL ASSESSMENT STATEMENT

INTRODUCTION

Based on the analysis and the screens contained in the Environmental Assessment Statement Short Form, the analysis areas that require further explanation include land use, zoning, and public policy (including waterfront revitalization), socioeconomics, community facilities, open space, shadows, historic and cultural resources, urban design and visual resources, hazardous materials, transportation, air quality, noise, neighborhood character, and construction as further detailed below. The subject heading numbers below correlate with the relevant chapters of the *CEQR Technical Manual*.

4. LAND USE, ZONING AND PUBLIC POLICY

Under the *City Environmental Quality Review (CEQR) Technical Manual* guidelines, a land use analysis evaluates the use and development trends in the area that may be affected by a proposed action and determines whether the proposed action is compatible with those conditions or may affect them. Similarly, the analysis considers the proposed action's compliance with, and effect on, the area's zoning and other applicable public policies.

The Proposed Actions consist of a Zoning Map Amendment that would rezone a portion of Block 4133 (Lots 1, 2, 8 (partial), 10, 12, 61, 62, and 63 (partial) and Block 4134 (Lots 1 and 14 [partial]) in Bronx Community District 11 from the existing M1-1 district to a R7A/C2-4 district. The Proposed Actions also include a Zoning Text Amendment to modify Zoning Resolution (ZR) Section 23-933, Appendix F to designate the newly mapped R7A/C2-4 district as a Mandatory Inclusionary Housing (MIH) designated area. The Proposed Actions also include a demapping of Fink Avenue between Blondell and Waters Avenues. With the proposed map and text amendments, the Applicant seeks to develop a new nine-story and cellar, 95'-0" tall mixed-use building totaling 261,660 gross square feet (gsf) [including cellar area] and containing 228 dwelling units within 198,683 gsf on floors 1-9 (plus 7,558 gsf of cellar space) on their Site (Block 4134, Lot 1, the "Project Site"). 227 of the 228 units would be considered affordable with 65% or 148 units at 80% of Area Median Income (AMI) or less and 35% or 79 units at 100% AMI or less as approved by HPD. One dwelling unit would be provided for the building superintendent and is not included in the affordability breakdown. The development would also contain 19,668 gsf of retail space and 2,024 gsf of community facility space. The development would include 225 attended accessory parking spaces.

The With-Action Scenario analyzes residential buildings with affordable housing on Projected Sites not owned by the Applicant, where future residential development

would be feasible. Per MIH guidelines, 25% or 30% - Option 1 or Option 2 - will be mapped over the affected area. Under Option 1, 25% of residential floor area must be for affordable housing units for residents with incomes averaging 60% AMI (\$46,620 for a family of three) with at least 10% of the residential floor area affordable at or below 40% AMI. Under Option 2, 30% of residential floor area must be for affordable housing units for residents with incomes averaging 80% AMI (\$62,150 for a family of three). The exact percentage of affordable units has not yet been determined, and the exact income bands pertaining to AMI have not been set. CEQR evaluates affordability at 80% AMI and below, yet the MIH options above do not necessarily restrict affordable units to an income band at 80% AMI and below (they may be affordable at levels greater than 80% of AMI). Therefore, for conservative analysis purposes in this EAS, it is assumed that of the affordable units to be set aside, approximately 20% of those units in the remainder of the affected area will be affordable at 80% of AMI and below.

As discussed in the Project Description, the Proposed Development on the Project Site is expected to be completed by 2022. As the Proposed Actions would result in the creation of multiple development Sites that are not controlled by the Applicant, it is anticipated that these Sites would be developed over a seven year period with a Build Year of 2029. Absent the Proposed Actions (the No-Action condition) it is assumed that existing conditions would continue on the Project Site and the Non-Applicant Owned Sites.

According to the *CEQR Technical Manual*, the appropriate study area for land use, zoning and public policy is related to the type and size of the project, as well as the location and context of the area that could be affected by the project. To assess the potential for project related impacts, the land use study area has been defined as the area located within a 400-foot radius of the proposed Rezoning Area/Affected Area. The 400-foot radius study area is generally bounded by an area between Roberts and Halperin Avenues on the north, an area south of East Tremont Avenue on the south, East Tremont Avenue on the west, and Waters Avenue on the east. Various sources have been used to prepare a comprehensive analysis of land use, zoning, and public policy characteristics of the area, including field surveys, studies of the neighborhood, census data, and land use and zoning maps.

LAND USE

Existing Conditions

Rezoning Area

The Rezoning Area (the area subject to the Zoning Map and Zoning Text Amendments) is located in the Westchester Square neighborhood of the Bronx on a portion of two blocks located between Blondell, Ponton, Waters, and Westchester Avenues. The Rezoning Area includes Block 4134, Lot 1 (formerly Block 4134, Lots 1, 2, 4, 62, 63, and 70 and Block 4133, Lot 12) and Lot 14 (partial) consisting of 50% of the to be demapped

portion of Ponton Avenue adjacent to the Rezoning Area; and Block 4133, Lots 1, 2, 8 (partial as the Fink Avenue portion of this lot is not zoned and is to be demapped in association with a change to the City Map), 10, 12, 61, 62, and 63 (partial as a portion of this lot is located outside of the Rezoning Area boundary). Block 4134, Lot 1 constitutes the Applicant's property which is proposed for development. Block 4133, Lots 1, 2, 8 (partial), 10, 61, 62, and 63 (partial) and Block 4134, Lot 14 (partial) would be rezoned but are not controlled by the Applicant. Development is projected to occur on Block 4133, Lots 1, 2, 10, 61/62, and 63 (p/o). No development would occur on Block 4133, Lot 8 or Block 4134, Lot 14 (p/o). The Fink Avenue portion of the 18,022 sf Block 4133, Lot 8 would be demapped and would not be developed but would be used as an access driveway to the project site. The Grant Street and Cooper Avenue portions of Block 4133, Lot 8 would continue to be used as a driveway access to the adjoining parcels. Block 4134, Lot 14 (p/o) consists of 50% of the to be demapped portion of Ponton Avenue (7,687 sf) and would be improved with parking. Based on the Ponton Avenue Demapping EAS (11DCP136X), which is not yet finalized, the demapped portion of Ponton Avenue would be used for accessory parking and vehicle storage. Up to 12 accessory parking spaces would be provided. No new construction would take place on this portion of Ponton Avenue beyond paving, fencing, lighting, and additional security features.

The 106,968 sf Rezoning Area is developed with 39,704 gsf of office and retail space, 6,775 gsf of storage and automobile related floor area (automobile repair and storage), 4,410 gsf of residential floor area for 4 market rate dwelling units, one abandoned 766 gsf dwelling unit, parking areas, street rights-of-way, and vacant land. The existing development on each of the Projected Development Sites as well as Other Sites is detailed below. See Land Use map.

Projected Development Sites

Projected Development Site 1 (Block 4134, Lot 1) – The 46,360 sf lot consists of the following former lots developed with 6,210 gsf of building floor area, which represents an FAR of 0.13 (0.02 residential, 0.02 commercial, and 0.10 manufacturing).

- Block 4133, Lot 12 and Block 4134, Lots 62 & 63 are used for vehicle parking and vehicle storage in connection with a towing facility.
- Block 4134, Lot 70 is vacant land used as a street (Cooper Avenue between Ponton and Fink Avenues)
- Block 4134, Lot 2 contains a one-story 4,500 gsf auto body repair facility (Caveman Cycles) occupying the entire lot.
- Block 4134, Lot 4 contains a two-story 944 gsf building used for offices (Darkside Collision + Tow), vehicle parking, and vehicle storage in connection with the towing facility.

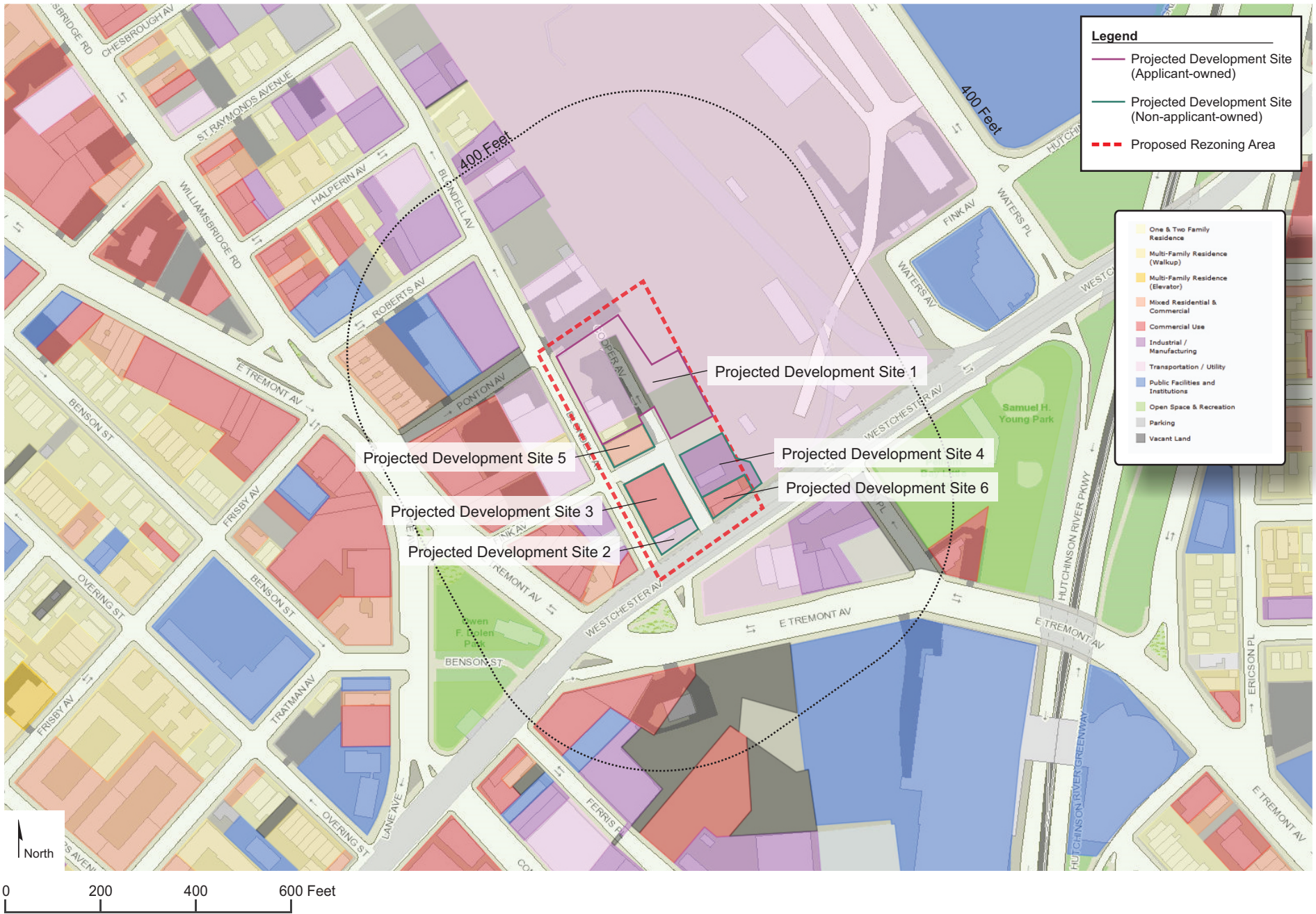

- Block 4134, Lot 1 contains a one- to two-story 766 gsf residential structure containing 1 dwelling unit (currently abandoned).

Projected Development Site 2 (Block 4133, Lot 1) is a 2,874 sf lot developed with two 1-story buildings totaling 1,075 gsf in size and used for automobile repair and storage (FAR of 0.37).

Projected Development Site 3 (Block 4133, Lot 2) is an 11,250 sf lot developed with a 1-story building totaling 24,900 gsf in size and used for office space, a garage, and related uses (FAR of 2.21).

Projected Development Site 4 (Block 4133, p/o Lot 63) is an 11,663 sf lot developed with a 1-story building totaling 1,200 gsf in size and used for storage (FAR of 0.1).

Projected Development Site 5 (Block 4133, Lot 10) is a 4,950 sf lot developed with a 2-story building totaling 13,230 gsf in size and used for 4 dwelling units (4,410 gsf) and 8,820 gsf of retail space (FAR of 2.67).

Projected Development Site 6 (Block 4133, Lots 61 and 62) consists of two lots that would be merged. The 1,642 sf Lot 61 is developed with a 2-story building totaling 3,040 gsf in size and used for office and retail space (FAR of 1.85). The 2,500 sf Lot 62 is developed with a 1-story building totaling 2,000 gsf in size and used for retail space (FAR of 0.8).

Other Sites

Other Site 1 (Block 4133, Lot 8) is an 18,022 sf cross shaped lot. The horizontal portion of the lot consists of Fink Avenue [aka Grant Street, the official name of the street on the City Map even though the street sign says Fink Avenue] which extends east from Blondell Avenue and is a mapped but unbuilt street. The vertical portion of the lot consists of Cooper Avenue which extends north from Westchester Avenue and is used as a driveway access to the adjoining parcels. Grant Street is also used as a driveway access to the adjoining parcels.

Other Site 2 (Block 4134, p/o Lot 14) is a 7,687 sf strip of land forming the northern boundary of the Rezoning Area consisting of 50% of the to be demapped portion of Ponton Avenue extending east from Blondell Avenue.

400-Foot Radius Project Study Area

The area surrounding the Rezoning Area is characterized by a wide variety of land uses including both single and multi-family residential, mixed use (residential-commercial), commercial, manufacturing, transportation/utilities, automotive/parking, and several parks and other community facilities. The New York City Transit's (NYCT) 6-Train

elevated subway line runs to the south of the Rezoning Area and a large NYCT Train Yard occupies the eastern portion of the project study area.

There are retail uses fronting on East Tremont Avenue in close proximity to the Westchester Square elevated subway station and light manufacturing, warehouse, storage yard, and automotive uses are located along both sides of Blondell Avenue. Retail uses consisting of newsstands, eating and drinking establishments, variety and discount stores, and other convenience retail uses are located to the southwest and west of the Rezoning Area. Most of these are located in one-story buildings, or on the ground floor of two- and three-story buildings (with either residential or office use above). Said buildings are built to the street line, and do not offer off-street parking, reflecting the pedestrian-oriented nature of the neighborhood.

Residential uses are mostly concentrated in the area to the west and northwest of the Rezoning Area. These neighborhoods include both single- and multi-family residential buildings. Lower density buildings are either detached, semi-detached, and attached homes of between 1-3 stories, and multi-family apartments buildings rise to 6-stories.

Manufacturing, transportation/utility, and automotive-related uses are mostly located in the underlying M1-1 district (to the north, south, east, and west of the Applicant Site), and in the smaller M3-1 district located to the south along Westchester Creek. Central among such uses is the NYCT Train Yard that is located adjacent to the east of the Applicant Site that measures approximately 750 feet by 2,000 feet, and consumes most of blocks 4133, 4134, 4137, 4138, 4139, 4140, 4141, 4142 and 4143. The remaining uses are light manufacturing, warehouse, and automotive uses, such as repair shops. These are generally located in one- and two- story detached buildings, and often have adjacent parking or storage yards.

Scattered throughout the surrounding area are a number of parks and other community facilities. Southwest of the proposed Rezoning Area, Owen F. Dolen Park is located in the triangular area bound by East Tremont Avenue, Westchester Avenue and Lane Avenue, adjacent to the Westchester Square elevated subway stop. One block to the east of the Rezoning Area, Samuel H. Young Park occupies the majority of Block 5380. One block southeast of the proposed Rezoning Area is the campus of Herbert H. Lehman High School (Block 5368, Lots 1 and 2), which spans the Hutchinson River Parkway. Aside from these notable examples, there are also a number of other smaller community facilities such as small houses of worship, libraries, schools, and a post office located in the surrounding area.

Future No-Action Scenario

Rezoning Area

Under the No-Action Scenario for the project build year of 2029, it is assumed that the six Projected Development Sites would remain in their existing condition as detailed above. No new as-of-right development would occur on the Projected Development Sites as the area's existing M1-1 zoning precludes the development of any residential uses. In addition, market conditions in the area are not supportive of the development of new or expanded manufacturing or 'free-standing' (without the development of residential uses) commercial uses. Although a maximum community facility FAR of 2.4 would be permitted on these lots, the proposed Rezoning Area and the surrounding project study area are primarily commercial and industrial in character and do not contain a residential population large enough to support community facility uses. Further explanation for why the individual Sites in the Rezoning Area would not be developed in the No-Action condition is provided below.

At an FAR of 2.21 and 2.67, respectively, Projected Development Sites 3 and 5 are developed in excess of the permitted FAR of 1.0 in the M1-1 district while Projected Development Site 6 is developed to an FAR of 0.8 which is close to the maximum permitted FAR. Although the remaining Projected Development Sites 1, 2, and 4 are developed at well below the maximum permitted FAR of 1.0, most of the surface area of these Sites is used for vehicle parking and storage in connection with vehicle repair and towing businesses located on these properties. Therefore, no further development would be anticipated on any of these Sites.

It is assumed that Other Site 1 would also remain in its existing condition as detailed above. The Fink Avenue portion of the lot is a mapped but unbuilt street. No change would occur to this portion of the lot absent the proposed demapping in the With-Action scenario. The Cooper Avenue and Grant Street portions of the lot would continue to be used as a driveway access to the adjoining parcels.

It is assumed that Other Site 2, which consists of 50% of the to be demapped portion of Ponton Avenue, would be improved with parking. Based on the Ponton Avenue Demapping EAS (11DCP136X), the demapped portion of Ponton Avenue would be used for accessory parking and vehicle storage. Up to 12 accessory parking spaces would be provided. No new construction would take place on this portion of Ponton Avenue beyond paving, fencing, lighting, and additional security features.

400-Foot Radius Project Study Area

A review was conducted of the NYC Department of City Planning's (DCP) Land Use & CEQR Application Tracking System (LUCATS) for Bronx Community District 11 for the past ten year period. This review found no uncompleted actions for the 400-foot radius

project study area. No development plans are known to exist for the existing parking lots or other uses within the project study area as identified above by the project build year of 2029.

Therefore, surrounding land uses within the immediate study area are expected to remain largely unchanged by the project build year of 2029. The 400-foot area surrounding the Rezoning Area is developed with a mixture of single and multi-family residences, mixed-use (residential-commercial) buildings, commercial and manufacturing uses, transportation/utilities including a large NYCT Train Yard, automotive/parking, and several parks and other community facilities. Other than the lots used for parking and vehicle storage which are heavily utilized, few usable undeveloped parcels remain within the project study area and it is therefore anticipated that no significant new development would occur within this area by 2029.

Future With-Action Scenario

Rezoning Area

Under the With-Action Scenario for the project build year of 2029, the six Projected Development Sites would be developed with six new buildings containing a total of 449,828 gsf of floor area including 384 dwelling units (based on an average size of 871 gsf per dwelling unit excluding cellar space) 260 of which would be affordable units, 48,729 gsf of commercial retail/office space, 2,024 gsf of community facility space (day care center and medical offices), and 265 accessory parking spaces. The existing 39,704 gsf of office and retail space, 6,775 gsf of storage and automobile related floor area (automobile repair and storage), 4,140 gsf of residential floor area for 4 market rate dwelling units, one abandoned 766 gsf dwelling unit, and parking areas would be removed. Other Site 1 would be partially demapped. The projected development on each of the six Development Sites and the two Other Sites is detailed below.

Projected Development Site 1 would be developed with a new nine-story and cellar, 95'-0" tall mixed-use building totaling 261,660 gsf (including cellar area) and containing 228 studio and one-, two-, and three-bedroom dwelling units within 198,683 gsf (excludes residential cellar area) on floors 1-9 based on an average size of 871 gsf per dwelling unit. All units would be affordable. The development would also include 19,668 gsf of retail space on the first/ground floor, 2,024 gsf of community facility space on the first floor (day care center and medical offices), and 225 attended parking spaces in the cellar and on the first floor of the building. For the purposes of Mandatory Inclusionary Housing (MIH), 30% or 68 of the 228 units would be required to be affordable to those at 80% of AMI or less. However, as approved by HPD, 227 of the 228 units would be considered affordable with 65% or 148 units at 80% of AMI or less and 35% or 79 units at 100% AMI or less. One dwelling unit would be provided for the building superintendent and is not included in the affordability breakdown.

Projected Development Site 2 would be developed with a 9-story, 95'-0" tall 13,616 gsf mixed-use building containing 11,686 gsf of residential floor area for 13 dwelling units, 3 of which would be affordable pursuant to MIH. The development would also include 1,930 gsf of ground floor commercial space. No parking would be provided.

Projected Development Site 3 would be developed with a 9-story, 95'-0" tall 64,552 gsf mixed-use building containing 42,745 gsf of residential floor area for 49 dwelling units, 10 of which would be affordable pursuant to MIH. The development would also include 10,557 gsf of ground floor commercial space and 11,250 gsf for cellar level parking. 19 cellar level parking spaces would be provided on the Site.

Projected Development Site 4 would be developed with a 9-story, 95'-0" tall 66,922 gsf mixed-use building containing 45,989 gsf of residential floor area for 53 dwelling units, 11 of which would be affordable pursuant to MIH. The development would also include 9,270 gsf of ground floor commercial space and 11,663 gsf for cellar level parking. 21 cellar level parking spaces would be provided on the Site.

Projected Development Site 5 would be developed with a 9-story, 95'-0" tall 23,453 gsf mixed-use building containing 19,385 gsf of residential floor area for 22 dwelling units, 5 of which would be affordable pursuant to MIH. The development would also include 4,068 gsf of ground floor commercial space. No parking would be provided.

Projected Development Site 6 would be developed with a 9-story, 95'-0" tall 19,625 gsf mixed-use building containing 16,389 gsf of residential floor area for 19 dwelling units, 4 of which would be affordable pursuant to MIH. The development would also include 3,236 gsf of ground floor commercial space. No parking would be provided.

The Fink Avenue portion of Other Site 1 would be demapped and would not be developed. The Cooper Avenue and Grant Street portions of this lot would continue to be used as a driveway access to the adjoining parcels.

As described in the Future No-Action section above, Other Site 2 would be improved with parking. Up to 12 accessory parking spaces would be provided. No new construction would take place on this portion of Ponton Avenue beyond paving, fencing, lighting, and additional security features.

The With-Action Scenario analyzes residential buildings with affordable housing on Projected Sites not owned by the Applicant, where future residential development would be feasible. Per MIH guidelines, 25% or 30% - Option 1 or Option 2 - will be mapped over the affected area. Under Option 1, 25% of residential floor area must be for affordable housing units for residents with incomes averaging 60% AMI (\$46,620 for a family of three) with at least 10% of the residential floor area affordable at or below

40% AMI. Under Option 2, 30% of residential floor area must be for affordable housing units for residents with incomes averaging 80% AMI (\$62,150 for a family of three). The exact percentage of affordable units has not yet been determined, and the exact income bands pertaining to AMI have not been set. CEQR evaluates affordability at 80% AMI and below, yet the MIH options above do not necessarily restrict affordable units to an income band at 80% AMI and below (they may be affordable at levels greater than 80% of AMI). Therefore, for conservative analysis purposes in this EAS, it is assumed that of the affordable units to be set aside, approximately 20% of those units in the remainder of the affected area will be affordable at 80% of AMI and below. All affordable units would be permanently affordable.

Table 4-1 below presents the No-Action and With-Action developments on the six Projected Development Sites and two Other Sites and shows the increment between these two scenarios.

Table 4-1						
No-Action and With-Action Development Scenarios and Increment						
Projected Develop Site #	Block/Lot	Applic/Non-Applic Owned	Lot Size (SF)	No-Action Scenario	With-Action Scenario	Increment
1	4134/1	Applicant	46,360	4,500 gsf auto body repair, 944 gsf offices, 766 gsf abandoned residential-1 DU, vehicle parking and vehicle storage for towing facility, vacant land used as a street	206,241 gsf residential-228 DUs (227 affordable), 19,668 gsf retail, 2,024 gsf comm facil, 225 parking spaces	Removed: 4,500 gsf auto body repair, 944 gsf offices, 766 gsf abandoned residential-1 DU, vehicle parking and vehicle storage for towing facility, vacant land used as a street Added: 206,241 gsf residential-228 DUs (227 affordable), 19,668 gsf retail, 2,024 gsf comm facil, 225 parking spaces
2	4133/1	Non-Applicant	2,874	1,075 gsf automobile repair and storage	11,686 gsf residential - 13 DUs (3 affordable), 1,930 gsf commercial	Removed: 1,075 gsf automobile repair and storage Added: 11,686 gsf residential - 13 DUs (3 affordable), 1,930 gsf commercial
3	4133/2	Non-Applicant	11,250	24,900 gsf office, garage, related uses	42,745 gsf residential - 49 DUs (10 affordable), 10,557 gsf commercial, 19 parking spaces	Removed: 24,900 gsf office, garage, related uses Added: 42,745 gsf residential - 49 DUs (10 affordable), 10,557 gsf commercial, 19 parking spaces

4	4133/ 63 (p/o)	Non-Applicant	11,663	1,200 gsf storage	45,989 gsf residential - 53 DUs (11 affordable), 9,270 gsf commercial, 21 parking spaces	Removed: 1,200 gsf storage Added: 45,989 gsf residential - 53 DUs (11 affordable), 9,270 gsf commercial, 21 parking spaces
5	4133/ 10	Non-Applicant	4,950	4,410 gsf residential - 4 residential -27 DUs, 8,820 gsf retail	19,385 gsf residential - 22 DUs (5 affordable), 4,068 gsf commercial	Removed: 4,410 gsf residential - 4 residential -27 DUs, 8,820 gsf retail Added: 19,385 gsf residential - 22 DUs (5 affordable), 4,068 gsf commercial
6	4133/ 61, 62	Non-Applicant	4,142	5,040 gsf office and retail	16,389 gsf residential - 19 DUs (4 affordable), 3,236 gsf commercial	Removed: 5,040 gsf office and retail Added: 16,389 gsf residential - 19 DUs (4 affordable), 3,236 gsf commercial
Other Site #	Block/Lot	Applic/Non-Applic Owned	Lot Size (SF)	No-Action Scenario	With-Action Scenario	Increment
1	4133/8	Non-Applicant	18,022	Mapped unbuilt street, driveway	Demapped street, driveway	Removed: mapped street Added: demapped street
2	4134/ 14 (p/o)	Non-Applicant	7,687	12 accessory parking spaces	12 accessory parking spaces	0

400-Foot Radius Project Study Area

The Proposed Actions would not result in any changes in land use within the 400-foot radius project study area.

Conclusion

The Applicant seeks to develop his property to provide 228 dwelling units, 227 of which would be considered affordable, together with 19,668 gsf of retail space, 2,024 gsf of community facility space, and 225 attended accessory parking spaces to serve project residents and other persons in the surrounding community.

Five additional Sites within the Rezoning Area are projected to be developed with five new buildings containing a total of 188,168 gsf of floor area including 156 dwelling units, 33 of which would be affordable units, 29,061 gsf of commercial space, and 40 accessory parking spaces. In addition, a mapped but unbuilt street would be demapped. This would constitute a significant land use change in the Rezoning Area but the Applicant believes this change would be beneficial as it would fully develop these underutilized Sites and would provide new housing, including affordable housing, commercial and community facility space, and accessory parking.

The projected developments on the non-Applicant Owned Sites would primarily replace automobile repair uses and parking lots and storage uses which would not be

considered to be a significant land use impact. The projected developments could alter existing development patterns in the surrounding project study area in the future, especially of the underutilized parking lots and vacant parcels, by encouraging the development of new residential uses. However, this would be in compliance with City policies to encourage the development of new housing, especially affordable housing, in underutilized areas of the City.

Based on the above analyses, it has been determined that no potentially significant adverse impacts related to land use are expected to occur as a result of the Proposed Actions. Therefore, further analysis of land use is not warranted.

ZONING

Existing Conditions

Rezoning Area

The Rezoning Area is currently zoned M1-1. The M1 district is often a buffer between M2 and M3 districts and adjacent residential or commercial districts. Light industries typically found in M1 areas include woodworking shops, auto storage and repair shops, and wholesale service and storage facilities. Offices, most retail uses, and some community facility uses are also permitted but residential uses are not allowed. Strict performance standards are common to all M1 districts. The M1-1 district permits a maximum FAR of 1.0 for manufacturing and commercial uses and 2.4 for Use Group 4 community facility uses. The M1-1 district permits a maximum building height of 30 feet. The M1-1 district requires a setback of 20 feet on narrow streets and 15 feet on wide streets and permits a maximum building height of 30 feet or two-stories, whichever is less. No front or side yards are generally required but a standard rear yard of 20 feet is required in the M1-1 district. Parking is required based on the type of use and the size of the establishment.

In 2008, two applications were filed to facilitate the development of a new seven-story mixed-use building on the Applicant Site. (ULURP Application Nos: 090085ZMX and 090086ZSX, CEQR No.: 09DCP008X; requesting a zoning map amendment and a special permit per ZR §74-512, respectively.) ULURP Application No.: 090085ZMX requested two zoning map amendments to rezone a portion of the M1-1 district to an R7-1 district, and to map a C2-4 overlay district in a portion of the proposed R7-1 district. ULURP Application No.: 090086ZSX requested a special permit pursuant to ZR §74-512 to allow for an off-street public parking facility to include 411 parking spaces. These applications were filed on August 19, 2008, but never reached certification, and have both been withdrawn. The subject application is a new land use application (ULURP Applications Nos: 170438ZMX and 170439ZRX).

400-Foot Radius Project Study Area

Most of the 400-foot radius project study area around the Rezoning Area is zoned M1-1 including the entire radius area to the north and east, the area to the south (north of East Tremont Avenue), and the area to the west (up to approximately 150 feet east of East Tremont Avenue). The area south of East Tremont Avenue is zoned in a combination of M1-1, M3-1, and R6 districts. A C2-4 commercial overlay is mapped over one blockfront along Westchester Avenue in this area. The project study area to the west of the Rezoning Area beyond the area zoned M1-1 is zoned R6/C1-2. C1-2 commercial overlays are mapped over all the easterly East Tremont Avenue blockfronts from Westchester Avenue to Roberts Avenue. The R6, C1-2, C2-4, and M3-1 districts are discussed below.

R6 zoning districts are widely mapped in built-up, medium-density areas of the City. The character of R6 districts can range from neighborhoods with a diverse mix of building types and heights to large-scale “tower in the park” developments. Two sets of bulk regulations apply in the R6 district. Standard height factor regulations produce small multi-family buildings on small zoning lots and, on larger lots, tall buildings that are set back from the street. Optional Quality Housing regulations produce high lot coverage buildings within height limits that often reflect the scale of older, pre-1961 apartment buildings in the neighborhood.

Buildings developed pursuant to height factor regulations are often tall buildings set back from the street and surrounded by open space and on-site parking. The FAR in R6 districts ranges from 0.78 (for a single-story building) to 2.43 at a typical height of 13 stories. It allows a community facility FAR of up to 4.8. There are no height limits for height factor buildings although they must be set within a sky exposure plane which begins at a height of 60 feet above the street line and then slopes inward over the zoning lot. Off-street parking is required for 70% of a building’s dwelling units.

The optional Quality Housing regulations produce high lot coverage buildings set at or near the street line. The FAR is 3.0; the maximum base height before setback is 60 feet with a maximum building height of 70 feet. On a narrow street (beyond 100 feet of a wide street), the maximum FAR is 2.2; the maximum base height before setback is 45 feet with a maximum building height of 55 feet. Off-street parking is required for 50% of all dwelling units.

C1 and C2 overlay districts accommodate the retail and personal service shops needed in residential neighborhoods, and are generally mapped along major avenues. C2 districts permit a slightly wider range of uses than C1 districts, such as funeral homes and repair shops. The maximum commercial FAR for C1-2 and C2-4 overlays in the R6 zone is 2.0. Residential uses are permitted within these overlays with residential bulk being governed by the provisions of the surrounding residential zone. Parking

requirements vary by use within the C1-2 zone with one parking space required for each 300 square feet of general retail and ambulatory diagnostic floor area. The C2-4 district requires one parking space required for each 1,000 square feet of general retail and ambulatory diagnostic floor area. No loading spaces are required for the first 8,000 square feet of floor area, and one loading berth is required for the next 17,000 square feet of commercial retail floor area.

M3 districts are for heavy industries that generate noise, traffic, or pollutants. Typical uses include power plants, solid waste transfer facilities and recycling plants, and fuel supply depots. M3 districts are usually located near the waterfront and are buffered from residential uses. Only manufacturing and commercial uses are located within this district. Uses with potential nuisance effects in M3 districts are required to conform to minimum performance standards. The M3-1 district permits a maximum commercial or manufacturing FAR of 2.0. The district permits a maximum building height of 60 feet. Parking is required based on the type of use and the size of the establishment.

On March 22, 2006 the Westchester Square Rezoning was approved (ULURP Application No.: C 060180 ZMX; CEQR No.: 06DCP034X). That action rezoned 17 full blocks and portions of 19 blocks, and modified commercial overlay districts, in the Westchester Square neighborhood. The purpose of the rezoning was to map contextual zoning districts that would better reflect the scale and character of the Westchester Square neighborhood and ensure that future development fit the prevailing neighborhood context of mid-density residential development. The rezoning also preserved the context of large detached single- and two-family homes in the inner blocks and apartment buildings along wider avenues in the rezoning area. In addition, 22 commercial overlays were modified to reduce parking requirements on shopping streets close to transit, eliminate one entire commercial overlay and part of another, and add one new commercial overlay. The depth of existing 150-foot commercial overlays was also reduced to 100 feet.

Most of the Rezoning Area was located north of Westchester Avenue, generally bounded by East Tremont Avenue and Castle Hill Avenue. The remaining portion was located south of Westchester Avenue, generally bounded by Seabury, Zerega and Waterbury Avenues. (All of which area is located to the west and south of the proposed Rezoning Area.)

Most recently, a City Map change was approved by the City Council in January of 2014, which affects an area adjacent to the proposed Rezoning Area (ULURP Application No.: 110342MMX; CEQR No.: 11DCP136X). This application involved the elimination, discontinuance, and closing of Ponton Avenue between Blondell Avenue and Waters Avenue (Block 4134, p/o Lot 14; Block 4139 p/o Lots 14, 101), and the adjustment of block dimensions and legal grades related thereto. The objective of this application was

to facilitate the sale of the existing street area for use as accessory parking to an existing automotive repair shop. It should be noted this action was unrelated to this application, but falls adjacent to the Applicant Site. Although the Ponton Avenue Demapping was adopted by the City Council, the map has not been filed and the map change has not been effectuated. Ponton Avenue is still a mapped City street pending the execution of a mapping agreement between the Applicant and the City.

Future No-Action Scenario

Rezoning Area

In the future and absent the Actions, the Rezoning Area would continue to be zoned M1-1.

400-Foot Radius Project Study Area

Based on a review of DCP's LUCATS listings for Bronx Community District 11, no rezoning applications are proposed for the 400-foot radius project study area. No rezoning actions are presently being contemplated by the DCP, as indicated on the DCP website, for the study area by the final project build year of 2029.

Future With-Action Scenario

Rezoning Area

The Proposed Actions consist of a Zoning Map Amendment, a Zoning Text Amendment, and a change to the City Map. The Zoning Map Amendment would rezone a portion of Block 4133 (Lots 1, 2, 8 (partial), 10, 12, 61, 62, and 63 (partial) and Block 4134 (Lots 1 and 14 [partial]) from the existing M1-1 district to a R7A/C2-4 district. The Proposed Actions also include a Zoning Text Amendment to modify ZR Section 23-933, Appendix F to designate the newly mapped R7A/C2-4 district as a Mandatory Inclusionary Housing (MIH) designated area. The Proposed Actions also include a demapping of Fink Avenue between Blondell and Waters Avenues.

As indicated above, the Rezoning Area is projected to be developed with six new buildings containing a total of 449,828 gsf of floor area including 384 dwelling units (based on an average size of 871 gsf per dwelling unit excluding cellar space) 260 of which would be affordable units, 48,729 gsf of commercial retail/office space, 2,024 gsf of community facility space (day care center and medical offices), and 265 accessory parking spaces. The existing 39,704 gsf of office and retail space, 6,775 gsf of storage and automobile related floor area (automobile repair and storage), 4,410 gsf of residential floor area for 4 market rate dwelling units, one vacant 766 gsf dwelling unit, and parking areas would be removed. In addition, Fink Avenue between Blondell and Waters Avenues would be demapped. Table 4-2 below summarizes the major provisions of the existing and proposed zoning districts as applicable to the six Projected Development Sites.

Table 4-2

No-Action and With-Action Development Scenarios and Increment

Proj Devel Site #	Existing Zoning					Proposed Zoning				
	Zoning	Max FAR	Max GSF	Max Ht	Use Groups	Zoning	Max FAR	Max GSF	Max Ht	Use Grps
1	M1-1	1.0 M, C; 2.4 CF	46,360 M, C; 111,312 CF	30' or 2- stories before setback	4-14, 16, 17	R7A/C2-4	4.6 R; 2.0 C; 4.0 CF	213,348 R; 92,760 C; 185,520 CF	95'	1-4, 6, 7B, 8, 9, 14
2	M1-1	1.0 M, C; 2.4 CF	2,874 M, C; 6,897 CF	30' or 2- stories before setback	4-14, 16, 17	R7A/C2-4	4.6 R; 2.0 C; 4.0 CF	13,220 R; 5,748 C; 11,496 CF	95'	1-4, 6, 7B, 8, 9, 14
3	M1-1	1.0 M, C; 2.4 CF	11,250 M, C; 27,000 CF	30' or 2- stories before setback	4-14, 16, 17	R7A/C2-4	4.6 R; 2.0 C; 4.0 CF	51,750 R; 22,500 C; 45,000 CF	95'	1-4, 6, 7B, 8, 9, 14
4	M1-1	1.0 M, C; 2.4 CF	11,663 M, C; 27,991 CF	30' or 2- stories before setback	4-14, 16, 17	R7A/C2-4	4.6 R; 2.0 C; 4.0 CF	53,649 R; 23,326 C; 46,652 CF	95'	1-4, 6, 7B, 8, 9, 14
5	M1-1	1.0 M, C; 2.4 CF	4,950 M, C; 11,880 CF	30' or 2- stories before setback	4-14, 16, 17	R7A/C2-4	4.6 R; 2.0 C; 4.0 CF	22,770 R; 9,900 C; 19,800 CF	95'	1-4, 6, 7B, 8, 9, 14
6	M1-1	1.0 M, C; 2.4 CF	4,142 M, C; 9,940 CF	30' or 2- stories before setback	4-14, 16, 17	R7A/C2-4	4.6 R; 2.0 C; 4.0 CF	19,053 R; 8,284 C; 16,568 CF	95'	1-4, 6, 7B, 8, 9, 14

The proposed R7A zoning district is a contextual zoning district that requires development to be in accordance with Quality Housing standards. The district typically produces high lot coverage seven- and eight-story apartment buildings, blending with existing buildings in many established neighborhoods. The maximum residential and community facility FAR in the R7A zone is 4.0. The residential FAR can be increased up to 4.6 with the Inclusionary Housing Program bonus. Above a base height of 40 to 65 feet, the building must set back to a depth of 10 feet on a wide street and 15 feet on a narrow street before rising to a maximum height of 80 feet. Parking is required for 50% of the dwelling units but may be waived if 15 or fewer spaces are required.

The proposed zoning map amendment also includes a C2-4 commercial overlay mapped over the Rezoning Area. The C2-4 overlay would permit a maximum commercial FAR of 2.0 for local retail services. The C2-4 district requires one parking space required for each 1,000 square feet of general retail and ambulatory diagnostic floor area. No loading spaces are required for the first 8,000 square feet of floor area, and one loading berth is required for the next 17,000 square feet of commercial retail floor area.

The proposed R7A/C2-4 district was chosen for the Rezoning Area in order to develop residential uses on the Applicant's property which is not allowed under its current M1-1 zoning. It is also required to allow the proposed bulk of the new building to be increased from the current permitted FAR of 1.0 for manufacturing and commercial uses and 2.4 for community facility uses to 4.0 for all permitted residential and community facility uses (manufacturing uses would not be allowed), 2.0 for commercial uses, and 4.6 as a bonus for inclusionary housing.

R7A/C2-4 zoning was chosen for the Rezoning Area as an R7-1 district is mapped on a block bounded by Westchester Avenue, Waters Place, Waters Avenue, and Fink Avenue just outside of the 400-foot radius project study area to the east. R6 zoning districts are also mapped within and just beyond 400 feet of the Rezoning Area to the south and west. C2-4 commercial overlays are mapped within and just beyond 400 feet of the Rezoning Area along Westchester Avenue to the southwest.

The proposed Zoning Text Amendment to modify ZR Section 23-933, Appendix F is necessary in order map the Rezoning Area as an MIH area. As approved by HPD, 227 of the 228 units on the Applicant Owned property would be considered affordable with 65% or 148 units at 80% of AMI or less and 35% or 79 units at 100% AMI or less. One dwelling unit would be provided for the building superintendent and is not included in the affordability breakdown.

The With-Action Scenario analyzes residential buildings with affordable housing on Projected Sites not owned by the Applicant, where future residential development would be feasible. Per MIH guidelines, 25% or 30% - Option 1 or Option 2 - will be mapped over the affected area. Under Option 1, 25% of residential floor area must be for affordable housing units for residents with incomes averaging 60% AMI (\$46,620 for a family of three) with at least 10% of the residential floor area affordable at or below 40% AMI. Under Option 2, 30% of residential floor area must be for affordable housing units for residents with incomes averaging 80% AMI (\$62,150 for a family of three). The exact percentage of affordable units has not yet been determined, and the exact income bands pertaining to AMI have not been set. CEQR evaluates affordability at 80% AMI and below, yet the MIH options above do not necessarily restrict affordable units to an income band at 80% AMI and below (they may be affordable at levels greater than 80% of AMI). Therefore, it is assumed that of the affordable units to be set aside, approximately 20% of those units in the remainder of the affected area will be affordable at 80% of AMI and below.

As an MIH area, developments within the proposed R7A district may build up to a maximum residential FAR of 4.6, the maximum base height may increase up to 75 feet, and the maximum total building height may increase up to 95 feet with qualifying ground floors or 90 feet without non-qualifying ground floors. The Text Amendment is

needed to provide the floor area needed to permit buildings that will be providing a large percentage of low- and middle-income dwelling units.

The proposed development on the Applicant's property would total 211,500 zsf (261,660 gsf) on the 46,360 sf lot representing an FAR of 4.56 and containing 189,808 zsf (198,683 gsf) of residential floor area (FAR of 4.09), 19,668 zsf/gsf of retail space (FAR of 0.42), and 2,024 zsf/gsf of community facility space (FAR of 0.04). Per ZR Sections 25-251, 36-21, and 44-21, 225 attended accessory parking spaces would be provided, including 128 residential spaces, 95 commercial spaces, and 2 community facility spaces.

The proposed development would consist of a one-story base which would cover approximately 24,022 sf or 51.8% of the 46,360 sf Project Site, upon which six additional floors would be built to a height of 75'-0" before setback. A portion of the 8th and 9th floors of the building would be set back 15'-0" from the Blondell Street frontage of the property to a building height at the roof of 95'-0", which is the maximum permitted building height for a building with a qualifying ground floor (5 additional feet per ZR 23-664). The project would be developed in accordance with the Zoning for Quality and Affordability (ZQA) provisions of the Zoning Resolution. A 30'-0" rear yard would be provided behind the building.

The proposed zoning change from M1-1 to R7A/C2-4 in other portions of the Rezoning Area in addition to the Applicant Owned Projected Development Site 1 would serve to increase the permitted bulk in that area from an FAR of 1.0 for manufacturing and commercial uses and 2.4 for community facility uses to an FAR of 4.0 for all permitted residential and community facility uses, 2.0 for commercial uses, and 4.6 as a bonus for inclusionary housing. It would allow Use Group 6 commercial retail and office uses and also expand the scope of permitted commercial uses to include Use Groups 7B, 8, 9, and 14, which are not permitted in the nearby C1 commercial districts. It would prohibit the establishment of currently permitted uses in Use Groups 5, 7A, 10, 11, 12, 13, 16, and 17. It would allow for the establishment of new uses in Use Groups 1-4 (residential and community facility use) in the Project Area. Under MIH and ZQA, parking would be provided for 25% of income restricted units and 50% of market rate units per ZR Sections 25-251 and 25-23, respectively. Pursuant to ZR Section 25-261, parking can be waived where fewer than 15 parking spaces are required.

The Applicant believes the increase in permitted bulk is appropriate given the City's policy of promoting increased development in close proximity to transit stops. The Applicant believes the change is also appropriate given the lack of demand for manufacturing facilities in this area, which is very underdeveloped. Although little new development has occurred recently in the immediately surrounding area, the proposed zoning change is believed to be appropriate given recent rezoning actions described under the Existing Conditions section above.

The Proposed Actions include a change to the City Map that involves the elimination, discontinuance and closing of Fink Avenue between Blondell Avenue and Waters Avenue (Block 4133, part of Lot 8), and the adjustment of grades necessitated thereby, including authorization for any acquisition or disposition of real property related thereto (demap a mapped but unbuilt portion of Fink Avenue that traverses the Development Site).

The subject portion of Fink Avenue (hereafter "the street to be eliminated") is owned by the Metropolitan Transit Authority and other private parties, is mapped to a width of 60 feet, is not open to traffic, and is not improved. The majority of the street to be eliminated is within a NYC Transit Maintenance Yard. Multiple train tracks, including an elevated subway line, cross over the street within the Maintenance Yard. The Yard is approximately zero feet to 17 feet below the grade of the surrounding streets and approximately five feet below the Applicant's property (on average). The total area of the street to be closed is 40,677.14 square feet.

The northeasterly portion of the street to be eliminated is a NYC Transit Maintenance Yard (Block 4133, Lot 23; Block 4134, Lot 14); the southwesterly portion includes parts of several privately-owned lots (Block 4133, Lots 8, 10, 12 and 23; Block 4134, Lot 1). Title for the street was vested in the City in 1946; however, the street was never built and the major length of it is used by the NYC Transit Maintenance Yard. The yard is owned and operated by the NYC Transit Authority. Access to the yard will not be affected by the street's elimination. Security fences currently enclose the entirety of the Maintenance Yard to prevent unauthorized access. Primary access to the Yard is via elevated train tracks or via entrances on Eastchester Road and Waters Place for vehicles. It is unlikely that any development will occur on the portion of the subject street that lies within and is an integral part of the NYC Transit Maintenance Yard and transit system.

The Applicant's property, which is proposed to be developed with a new mixed-use building, includes Block 4134, Lot 1; and Block 4133, Lot 12. The portion of the Development Site that rests within the street to be eliminated is part or all of Block 4133, Lot 12 and Block 4134, Lot 1. The remaining properties within the street to be eliminated (neither part of the Development Site nor the NYC Transit Maintenance Yard) are improved upon as follows: Block 4133, Lot 8 is a cross-shaped lot that is currently used as a right-of-way, known as Cooper Avenue and Grant Street. The portion of Lot 8 that is within the bed of the street to be eliminated is a paved dead end stub that is used as street parking. Block 4133, Lot 10 is improved upon with a 13,230 square foot, two-story mixed use building that includes a catering establishment on the ground floor, and residential apartments above.

The Applicant plans to use the portion of the street to be eliminated that is within the Development Site to provide driveway access to the Site as it does currently. The

requested elimination of this portion of Fink Avenue makes ample sense given current conditions for several reasons: (1) The portion of the street in question is mapped, but unbuilt; (2) Given the location of an MTA NYC Transit train yard located to the east of the Development Site, it is highly unlikely the City will ever exercise its ability to build this portion of the street; (3) An application was approved to demap a parallel portion of Ponton Avenue (one block north) to a similar extent, further indicating that this portion of the originally proposed street network will not be built out (ULURP Application No.: 110342MMX; CEQR No.: 11DCP136X); and (4) the area that would theoretically benefit from the building of this portion of Fink Avenue is already accessible from the private streets known as Grant Street and Cooper Avenue, which predate the mapping of Fink Avenue.

400-Foot Radius Project Study Area

The Proposed Actions would not result in any changes in zoning in the 400-foot radius project study area.

Conclusion

The proposed Zoning Map and Zoning Text Amendments would only apply to the Rezoning Area and would not affect lots beyond this area. The Applicant believes that the Proposed Actions would not result in any significant impacts to zoning patterns in the area since the mapping of the proposed R7A/C2-4 zoning district in the Rezoning Area would result in development that would be compatible with the existing mixed neighborhood context while also providing enough floor area to develop affordable dwelling units on the Applicant Site and on certain non-Applicant owned Sites. The Applicant believes the change in zoning would be appropriate for this area as the proposed R7A/C2-4 zoning district would be similar to the R7-1 district mapped on a block just outside of the 400-foot radius project study area to the east as well as the C2-4 commercial overlays mapped within and just beyond 400 feet of the Rezoning Area along Westchester Avenue to the southwest. R6 zoning districts are also mapped within and just beyond 400 feet of the Rezoning Area to the south and west. The Applicant believes the current M1-1 zoning is no longer believed to be appropriate for the project area given the lack of demand for manufacturing facilities in this area, which is very underdeveloped.

Based on the above analysis, it has been determined that no potentially significant adverse impacts related to zoning are expected to occur as a result of the Proposed Actions. Therefore, further analysis of zoning is not warranted.

PUBLIC POLICY

Existing Conditions

According to the *CEQR Technical Manual*, a project that would be located within areas governed by public policies controlling land use, or that has the potential to substantially affect land use regulation or policy controlling land use, requires an analysis of public policy. Public policies applicable to the Rezoning Area and 400-foot radius project study area are discussed below.

Rezoning Area and 400-Foot Radius Project Study Area

The Rezoning Area and the entire 400-foot radius project study area are located within the City's Coastal zone boundary. These areas are therefore subject to the provisions of the City's Waterfront Revitalization Program (WRP).

The Food Retail Expansion to Support Health (FRESH) program is mapped over the entire Rezoning Area and over the 400-foot radius project study area area. The City has established the FRESH program in response to the issues raised in neighborhoods that are underserved by grocery stores. FRESH provides zoning and financial incentives to promote the establishment and retention of neighborhood grocery stores in underserved communities throughout the five boroughs. The FRESH program is open to grocery store operators renovating existing retail space or developers seeking to construct or renovate retail space that will be leased by a full-line grocery store operator. Stores that benefit from the FRESH program must provide a minimum of 6,000 square feet of retail space for a general line of food and nonfood grocery products intended for home preparation, consumption and utilization. The Project Site is eligible for various tax incentives related to grocery store development and operation.

The western and southern portions of the 400-foot radius project study area along East Tremont Avenue are located within the 0.1 square mile Westchester Square Business Improvement District (WSBID) which extends from Seabury Avenue on the south to Silver Street on the north. The mission of the WSBID is to make the Westchester Square district cleaner, safer, more beautiful, and to undertake enhancement projects. The BID focuses its efforts on supplemental sanitation and promoting and marketing the area's business and cultural offerings.

The Rezoning Area and the 400-foot radius project study area are located within the boundaries of the Hutchinson River Parkway Study which is a transportation study of the Hutchinson River Parkway Corridor that began in the spring of 2013. The corridor study area lies roughly along the Hutchinson River Parkway/ New England Thruway between Baychester Avenue/Pelham Parkway and Ferry Point Park. The purpose of the Study is to evaluate the transportation needs along and surrounding the Hutchinson River Parkway corridor with the goal of improving existing conditions and developing

longer-term recommendations for improvements as the area continues to grow. The Rezoning Area and the 400-foot radius project study area are located within the Study's secondary study area. Specific concerns identified in the Study that would be applicable to the Rezoning Area and/or the 400-foot radius project study area include illegal pedestrian midblock crossings observed in the Westchester Square Area, insufficient on-street parking in this area to meet the needs of the local residents, and safety improvements at the Westchester Avenue and East Tremont Avenue intersection and in the area of East Tremont Avenue between Fink, Ponton and Lane Avenues (Westchester Square Area).

No other public policies would apply to the Proposed Actions as the Rezoning Area and the surrounding 400-foot radius study area are not located within the boundaries of any 197-a Community Development Plans or Urban Renewal Area plans, and also are not within a critical environmental area, a significant coastal fish and wildlife habitat, a wildlife refuge, or a special natural waterfront area. No Historic Districts or individually designated historic resources are located within the Rezoning Area or the surrounding 400-foot radius study area.

Future No-Action Scenario

In the future, without the Actions, new development in the Rezoning Area and within the 400-foot radius project study area would remain within the boundaries of the City's Coastal Zone, and therefore subject to the provisions of the WRP. These areas would also remain subject to the provisions of the FRESH Program. Similarly, new development within affected portions of the 400-foot radius project study area located within the WSBID would be subject to BID requirements. The concerns and recommendations of the Hutchinson River Parkway Study would also continue to be applicable to the Rezoning Area and surrounding study area. No other public policy initiatives would pertain to the Rezoning Area or to the 400-foot study area around the Area by the project build year of 2029. In addition, no changes are anticipated to any public policy documents relating to the Rezoning Area or the surrounding study area by the project build year.

Future With-Action Scenario

Mayor Bill de Blasio has implemented a plan entitled "Housing New York: A Five Borough Ten Year Plan". In July 2018 as part of the Housing New York 2.0 Plan, the Mayor has made affordable housing a top priority of his administration and has committed the City to build or preserve nearly 300,000 affordable units by the year 2026, and help both tenants and small landlords preserve the quality and affordability of their homes.

As part of the Mayor's Housing New York plan, the City Council has approved a citywide zoning text amendment to authorize a Mandatory Inclusionary Housing

(MIH) program (ULURP # 160051ZRY). The purpose of the MIH program is to promote neighborhood economic diversity in locations where land use actions create substantial new housing opportunities. The text amendment will have no effect until mapped through subsequent discretionary actions of the CPC, each of which will be subject to a public review process and separate environmental review. As with zoning actions generally, MIH Areas may be applied through DCP-initiated actions or as part of private applications, including certain zoning map amendments, text amendments, and Special Permits that create opportunities for significant new housing development. The MIH program requires (through zoning) that when CPC actions create significant new housing capacity in medium and high-density areas, either 25 or 30 percent of new housing would be permanently affordable. Under the proposal, the CPC and ultimately the City Council would apply at least one of these requirements to each MIH area:

- 25 percent of residential floor area must be for affordable housing units for residents with incomes averaging 60 percent Area Median Income (AMI) (\$46,620 for a family of three) with at least 10% of the residential floor area affordable at or below 40% AMI; or
- 30 percent of residential floor area must be for affordable housing units for residents with incomes averaging 80 percent AMI (\$62,150 for a family of three).

In addition to the options above, the City Council and the CPC could decide to apply one or both of the following options:

- A deep affordability option, where
 - o 20% of the total residential floor area must be for housing units for residents with incomes averaging 40% AMI (\$31,080 per year for a family of three);
 - o No direct subsidies could be used for these units except where needed to support more affordable housing; or
- An additional, workforce option for markets where moderate-income development is marginally feasible without subsidy. Under this option,
 - o 30 percent of the residential floor area must be for housing units for residents with incomes averaging 115 percent AMI (\$104,895/year for a family of three);
 - o No units could go to residents with incomes above 130 percent AMI (\$101,010/year for a family of three);
 - o No direct subsidies could be used for these affordable housing units; and
 - o This option would not be available in Manhattan CDs 1-8, which extend south of 96th Street on the east side and south of 110th Street on the west side.

Requirements would apply to developments, enlargements and residential conversions of more than ten units. Developments between 11 and 25 units would have the optional alternative of making a payment into an affordable housing fund, to be used to support affordable housing within that Community District. As indicated, the Proposed Actions include a Zoning Text Amendment to modify ZR Section 23-933, Appendix F to designate the newly mapped R7A/C2-4 district as an Inclusionary Housing designated area. Under the MIH provisions applicable to the project, and as approved by HPD, 227 of the 228 units would be considered affordable with 65% or 148 units at 80% of AMI or less and 35% or 79 units at 100% AMI or less as approved by HPD. One dwelling unit would be provided for the building superintendent and is not included in the affordability breakdown.

The With-Action Scenario analyzes residential buildings with affordable housing on Projected Sites not owned by the Applicant, where future residential development would be feasible. Per MIH guidelines, 25% or 30% - Option 1 or Option 2 - will be mapped over the affected area. Under Option 1, 25% of residential floor area must be for affordable housing units for residents with incomes averaging 60% AMI (\$46,620 for a family of three) with at least 10% of the residential floor area affordable at or below 40% AMI. Under Option 2, 30% of residential floor area must be for affordable housing units for residents with incomes averaging 80% AMI (\$62,150 for a family of three). The exact percentage of affordable units has not yet been determined, and the exact income bands pertaining to AMI have not been set. CEQR evaluates affordability at 80% AMI and below, yet the MIH options above do not necessarily restrict affordable units to an income band at 80% AMI and below (they may be affordable at levels greater than 80% of AMI). Therefore, for conservative analysis purposes in this EAS, it is assumed that of the affordable units to be set aside, approximately 20% of those units in the remainder of the affected area will be affordable at 80% of AMI and below.

Waterfront approval is required for the proposed development as the Rezoning Area is located within the City's Coastal Zone Boundary Area and the project must be assessed for its consistency with the City's Waterfront Revitalization Program. The Waterfront Consistency Assessment Form and a narrative explaining how the Proposed Actions would be consistent with WRP policies are attached to this document. The narrative explains how the Actions comply with the policies noted after each Consistency Assessment Form question that has been affirmatively responded to. The Proposed Actions are consistent with WRP policies, and no potentially significant adverse impacts related to the WRP are anticipated as a result of these Actions.

The FRESH program would not be relevant to the Proposed Actions as grocery stores are not currently located on any of the Projected or Potential Development Sites and are not proposed.

It is not anticipated that the concerns and recommendations of the Hutchinson River Parkway Study would affect any development within the proposed Rezoning Area.

The proposed development would not have any impact on the Coastal Zone, the WSBD, or the concerns and recommendations of the Hutchinson River Parkway Study within a 400-foot radius of the Rezoning Area.

Conclusion

No impact to public policies would occur as a result of the Proposed Actions. The Applicant believes that the Proposed Actions would be an appropriate development in the Rezoning Area and would be a positive contribution to Bronx Community District 11 and to the surrounding neighborhood.

The proposed project would meet the City's public policy goals related to MIH and Housing New York as explained above as well as similar State and national public policy goals related to the provision of affordable housing. All development would comply with the provisions of the City's WRP applicable to the Coastal Zone area.

Based on the above analyses, it has been determined that no potentially significant adverse impacts related to public policy are expected to occur as a result of the Proposed Actions. Therefore, further analysis of public policy is not warranted.

NEW YORK CITY WATERFRONT REVITALIZATION PROGRAM Consistency Assessment Form

Proposed actions that are subject to CEQR, ULURP or other local, state or federal discretionary review procedures, and that are within New York City's Coastal Zone, must be reviewed and assessed for their consistency with the [New York City Waterfront Revitalization Program](#) (WRP) which has been approved as part of the State's Coastal Management Program.

This form is intended to assist an applicant in certifying that the proposed activity is consistent with the WRP. It should be completed when the local, state, or federal application is prepared. The completed form and accompanying information will be used by the New York State Department of State, the New York City Department of City Planning, or other city or state agencies in their review of the applicant's certification of consistency.

A. APPLICANT INFORMATION

Name of Applicant: _____

Name of Applicant Representative: _____

Address: _____

Telephone: _____ Email: _____

Project site owner (if different than above): _____

B. PROPOSED ACTIVITY

If more space is needed, include as an attachment.

1. Brief description of activity

2. Purpose of activity

C. PROJECT LOCATION

Borough: _____ Tax Block/Lot(s): _____

Street Address: _____

Name of water body (if located on the waterfront): _____

D. REQUIRED ACTIONS OR APPROVALS

Check all that apply.

City Actions/Approvals/Funding

City Planning Commission

Yes No

- | | | |
|---|--|--|
| <input type="checkbox"/> City Map Amendment | <input type="checkbox"/> Zoning Certification | <input type="checkbox"/> Concession |
| <input type="checkbox"/> Zoning Map Amendment | <input type="checkbox"/> Zoning Authorizations | <input type="checkbox"/> UDAAP |
| <input type="checkbox"/> Zoning Text Amendment | <input type="checkbox"/> Acquisition – Real Property | <input type="checkbox"/> Revocable Consent |
| <input type="checkbox"/> Site Selection – Public Facility | <input type="checkbox"/> Disposition – Real Property | <input type="checkbox"/> Franchise |
| <input type="checkbox"/> Housing Plan & Project | <input type="checkbox"/> Other, explain: _____ | |
| <input type="checkbox"/> Special Permit | | |
- (if appropriate, specify type: Modification Renewal other) Expiration Date: _____

Board of Standards and Appeals

Yes No

- Variance (use)
- Variance (bulk)
- Special Permit
- (if appropriate, specify type: Modification Renewal other) Expiration Date: _____

Other City Approvals

- | | |
|--|---|
| <input type="checkbox"/> Legislation | <input type="checkbox"/> Funding for Construction, specify: _____ |
| <input type="checkbox"/> Rulemaking | <input type="checkbox"/> Policy or Plan, specify: _____ |
| <input type="checkbox"/> Construction of Public Facilities | <input type="checkbox"/> Funding of Program, specify: _____ |
| <input type="checkbox"/> 384 (b) (4) Approval | <input type="checkbox"/> Permits, specify: _____ |
| <input type="checkbox"/> Other, explain: _____ | |

State Actions/Approvals/Funding

- State permit or license, specify Agency: _____ Permit type and number: _____
- Funding for Construction, specify: _____
- Funding of a Program, specify: _____
- Other, explain: _____

Federal Actions/Approvals/Funding

- Federal permit or license, specify Agency: _____ Permit type and number: _____
- Funding for Construction, specify: _____
- Funding of a Program, specify: _____
- Other, explain: _____

Is this being reviewed in conjunction with a [Joint Application for Permits?](#) Yes No

E. LOCATION QUESTIONS

1. Does the project require a waterfront site? Yes No
2. Would the action result in a physical alteration to a waterfront site, including land along the shoreline, land under water or coastal waters? Yes No
3. Is the project located on publicly owned land or receiving public assistance? Yes No
4. Is the project located within a FEMA 1% annual chance floodplain? (6.2) Yes No
5. Is the project located within a FEMA 0.2% annual chance floodplain? (6.2) Yes No
6. Is the project located adjacent to or within a special area designation? See [Maps – Part III](#) of the NYC WRP. If so, check appropriate boxes below and evaluate policies noted in parentheses as part of WRP Policy Assessment (Section F).
 - Significant Maritime and Industrial Area (SMIA) (2.1)
 - Special Natural Waterfront Area (SNWA) (4.1)
 - Priority Martine Activity Zone (PMAZ) (3.5)
 - Recognized Ecological Complex (REC) (4.4)
 - West Shore Ecologically Sensitive Maritime and Industrial Area (ESMIA) (2.2, 4.2)

F. WRP POLICY ASSESSMENT

Review the project or action for consistency with the WRP policies. For each policy, check Promote, Hinder or Not Applicable (N/A). For more information about consistency review process and determination, see **Part I** of the [NYC Waterfront Revitalization Program](#). When assessing each policy, review the full policy language, including all sub-policies, contained within **Part II** of the WRP. The relevance of each applicable policy may vary depending upon the project type and where it is located (i.e. if it is located within one of the special area designations).

For those policies checked Promote or Hinder, provide a written statement on a separate page that assesses the effects of the proposed activity on the relevant policies or standards. If the project or action promotes a policy, explain how the action would be consistent with the goals of the policy. If it hinders a policy, consideration should be given toward any practical means of altering or modifying the project to eliminate the hindrance. Policies that would be advanced by the project should be balanced against those that would be hindered by the project. If reasonable modifications to eliminate the hindrance are not possible, consideration should be given as to whether the hindrance is of such a degree as to be substantial, and if so, those adverse effects should be mitigated to the extent practicable.

		Promote	Hinder	N/A
I	Support and facilitate commercial and residential redevelopment in areas well-suited to such development.	<input type="checkbox"/>	<input type="checkbox"/>	<input type="checkbox"/>
1.1	Encourage commercial and residential redevelopment in appropriate Coastal Zone areas.	<input type="checkbox"/>	<input type="checkbox"/>	<input type="checkbox"/>
1.2	Encourage non-industrial development with uses and design features that enliven the waterfront and attract the public.	<input type="checkbox"/>	<input type="checkbox"/>	<input type="checkbox"/>
1.3	Encourage redevelopment in the Coastal Zone where public facilities and infrastructure are adequate or will be developed.	<input type="checkbox"/>	<input type="checkbox"/>	<input type="checkbox"/>
1.4	In areas adjacent to SMIA's, ensure new residential development maximizes compatibility with existing adjacent maritime and industrial uses.	<input type="checkbox"/>	<input type="checkbox"/>	<input type="checkbox"/>
1.5	Integrate consideration of climate change and sea level rise into the planning and design of waterfront residential and commercial development, pursuant to WRP Policy 6.2.	<input type="checkbox"/>	<input type="checkbox"/>	<input type="checkbox"/>

		Promote	Hinder	N/A
2	Support water-dependent and industrial uses in New York City coastal areas that are well-suited to their continued operation.	<input type="checkbox"/>	<input type="checkbox"/>	<input type="checkbox"/>
2.1	Promote water-dependent and industrial uses in Significant Maritime and Industrial Areas.	<input type="checkbox"/>	<input type="checkbox"/>	<input type="checkbox"/>
2.2	Encourage a compatible relationship between working waterfront uses, upland development and natural resources within the Ecologically Sensitive Maritime and Industrial Area.	<input type="checkbox"/>	<input type="checkbox"/>	<input type="checkbox"/>
2.3	Encourage working waterfront uses at appropriate sites outside the Significant Maritime and Industrial Areas or Ecologically Sensitive Maritime Industrial Area.	<input type="checkbox"/>	<input type="checkbox"/>	<input type="checkbox"/>
2.4	Provide infrastructure improvements necessary to support working waterfront uses.	<input type="checkbox"/>	<input type="checkbox"/>	<input type="checkbox"/>
2.5	Incorporate consideration of climate change and sea level rise into the planning and design of waterfront industrial development and infrastructure, pursuant to WRP Policy 6.2.	<input type="checkbox"/>	<input type="checkbox"/>	<input type="checkbox"/>
3	Promote use of New York City's waterways for commercial and recreational boating and water-dependent transportation.	<input type="checkbox"/>	<input type="checkbox"/>	<input type="checkbox"/>
3.1.	Support and encourage in-water recreational activities in suitable locations.	<input type="checkbox"/>	<input type="checkbox"/>	<input type="checkbox"/>
3.2	Support and encourage recreational, educational and commercial boating in New York City's maritime centers.	<input type="checkbox"/>	<input type="checkbox"/>	<input type="checkbox"/>
3.3	Minimize conflicts between recreational boating and commercial ship operations.	<input type="checkbox"/>	<input type="checkbox"/>	<input type="checkbox"/>
3.4	Minimize impact of commercial and recreational boating activities on the aquatic environment and surrounding land and water uses.	<input type="checkbox"/>	<input type="checkbox"/>	<input type="checkbox"/>
3.5	In Priority Marine Activity Zones, support the ongoing maintenance of maritime infrastructure for water-dependent uses.	<input type="checkbox"/>	<input type="checkbox"/>	<input type="checkbox"/>
4	Protect and restore the quality and function of ecological systems within the New York City coastal area.	<input type="checkbox"/>	<input type="checkbox"/>	<input type="checkbox"/>
4.1	Protect and restore the ecological quality and component habitats and resources within the Special Natural Waterfront Areas.	<input type="checkbox"/>	<input type="checkbox"/>	<input type="checkbox"/>
4.2	Protect and restore the ecological quality and component habitats and resources within the Ecologically Sensitive Maritime and Industrial Area.	<input type="checkbox"/>	<input type="checkbox"/>	<input type="checkbox"/>
4.3	Protect designated Significant Coastal Fish and Wildlife Habitats.	<input type="checkbox"/>	<input type="checkbox"/>	<input type="checkbox"/>
4.4	Identify, remediate and restore ecological functions within Recognized Ecological Complexes.	<input type="checkbox"/>	<input type="checkbox"/>	<input type="checkbox"/>
4.5	Protect and restore tidal and freshwater wetlands.	<input type="checkbox"/>	<input type="checkbox"/>	<input type="checkbox"/>
4.6	In addition to wetlands, seek opportunities to create a mosaic of habitats with high ecological value and function that provide environmental and societal benefits. Restoration should strive to incorporate multiple habitat characteristics to achieve the greatest ecological benefit at a single location.	<input type="checkbox"/>	<input type="checkbox"/>	<input type="checkbox"/>
4.7	Protect vulnerable plant, fish and wildlife species, and rare ecological communities. Design and develop land and water uses to maximize their integration or compatibility with the identified ecological community.	<input type="checkbox"/>	<input type="checkbox"/>	<input type="checkbox"/>
4.8	Maintain and protect living aquatic resources.	<input type="checkbox"/>	<input type="checkbox"/>	<input type="checkbox"/>

		Promote	Hinder	N/A
5	Protect and improve water quality in the New York City coastal area.	<input type="checkbox"/>	<input type="checkbox"/>	<input type="checkbox"/>
5.1	Manage direct or indirect discharges to waterbodies.	<input type="checkbox"/>	<input type="checkbox"/>	<input type="checkbox"/>
5.2	Protect the quality of New York City's waters by managing activities that generate nonpoint source pollution.	<input type="checkbox"/>	<input type="checkbox"/>	<input type="checkbox"/>
5.3	Protect water quality when excavating or placing fill in navigable waters and in or near marshes, estuaries, tidal marshes, and wetlands.	<input type="checkbox"/>	<input type="checkbox"/>	<input type="checkbox"/>
5.4	Protect the quality and quantity of groundwater, streams, and the sources of water for wetlands.	<input type="checkbox"/>	<input type="checkbox"/>	<input type="checkbox"/>
5.5	Protect and improve water quality through cost-effective grey-infrastructure and in-water ecological strategies.	<input type="checkbox"/>	<input type="checkbox"/>	<input type="checkbox"/>
6	Minimize loss of life, structures, infrastructure, and natural resources caused by flooding and erosion, and increase resilience to future conditions created by climate change.	<input type="checkbox"/>	<input type="checkbox"/>	<input type="checkbox"/>
6.1	Minimize losses from flooding and erosion by employing non-structural and structural management measures appropriate to the site, the use of the property to be protected, and the surrounding area.	<input type="checkbox"/>	<input type="checkbox"/>	<input type="checkbox"/>
6.2	Integrate consideration of the latest New York City projections of climate change and sea level rise (as published in <i>New York City Panel on Climate Change 2015 Report, Chapter 2: Sea Level Rise and Coastal Storms</i>) into the planning and design of projects in the city's Coastal Zone.	<input type="checkbox"/>	<input type="checkbox"/>	<input type="checkbox"/>
6.3	Direct public funding for flood prevention or erosion control measures to those locations where the investment will yield significant public benefit.	<input type="checkbox"/>	<input type="checkbox"/>	<input type="checkbox"/>
6.4	Protect and preserve non-renewable sources of sand for beach nourishment.	<input type="checkbox"/>	<input type="checkbox"/>	<input type="checkbox"/>
7	Minimize environmental degradation and negative impacts on public health from solid waste, toxic pollutants, hazardous materials, and industrial materials that may pose risks to the environment and public health and safety.	<input type="checkbox"/>	<input type="checkbox"/>	<input type="checkbox"/>
7.1	Manage solid waste material, hazardous wastes, toxic pollutants, substances hazardous to the environment, and the unenclosed storage of industrial materials to protect public health, control pollution and prevent degradation of coastal ecosystems.	<input type="checkbox"/>	<input type="checkbox"/>	<input type="checkbox"/>
7.2	Prevent and remediate discharge of petroleum products.	<input type="checkbox"/>	<input type="checkbox"/>	<input type="checkbox"/>
7.3	Transport solid waste and hazardous materials and site solid and hazardous waste facilities in a manner that minimizes potential degradation of coastal resources.	<input type="checkbox"/>	<input type="checkbox"/>	<input type="checkbox"/>
8	Provide public access to, from, and along New York City's coastal waters.	<input type="checkbox"/>	<input type="checkbox"/>	<input type="checkbox"/>
8.1	Preserve, protect, maintain, and enhance physical, visual and recreational access to the waterfront.	<input type="checkbox"/>	<input type="checkbox"/>	<input type="checkbox"/>
8.2	Incorporate public access into new public and private development where compatible with proposed land use and coastal location.	<input type="checkbox"/>	<input type="checkbox"/>	<input type="checkbox"/>
8.3	Provide visual access to the waterfront where physically practical.	<input type="checkbox"/>	<input type="checkbox"/>	<input type="checkbox"/>
8.4	Preserve and develop waterfront open space and recreation on publicly owned land at suitable locations.	<input type="checkbox"/>	<input type="checkbox"/>	<input type="checkbox"/>

		Promote	Hinder	N/A
8.5	Preserve the public interest in and use of lands and waters held in public trust by the State and City.	<input type="checkbox"/>	<input type="checkbox"/>	<input type="checkbox"/>
8.6	Design waterfront public spaces to encourage the waterfront's identity and encourage stewardship.	<input type="checkbox"/>	<input type="checkbox"/>	<input type="checkbox"/>
9	Protect scenic resources that contribute to the visual quality of the New York City coastal area.	<input type="checkbox"/>	<input type="checkbox"/>	<input type="checkbox"/>
9.1	Protect and improve visual quality associated with New York City's urban context and the historic and working waterfront.	<input type="checkbox"/>	<input type="checkbox"/>	<input type="checkbox"/>
9.2	Protect and enhance scenic values associated with natural resources.	<input type="checkbox"/>	<input type="checkbox"/>	<input type="checkbox"/>
10	Protect, preserve, and enhance resources significant to the historical, archaeological, architectural, and cultural legacy of the New York City coastal area.	<input type="checkbox"/>	<input type="checkbox"/>	<input type="checkbox"/>
10.1	Retain and preserve historic resources, and enhance resources significant to the coastal culture of New York City.	<input type="checkbox"/>	<input type="checkbox"/>	<input type="checkbox"/>
10.2	Protect and preserve archaeological resources and artifacts.	<input type="checkbox"/>	<input type="checkbox"/>	<input type="checkbox"/>

G. CERTIFICATION

The applicant or agent must certify that the proposed activity is consistent with New York City's approved Local Waterfront Revitalization Program, pursuant to New York State's Coastal Management Program. If this certification cannot be made, the proposed activity shall not be undertaken. If this certification can be made, complete this Section.

"The proposed activity complies with New York State's approved Coastal Management Program as expressed in New York City's approved Local Waterfront Revitalization Program, pursuant to New York State's Coastal Management Program, and will be conducted in a manner consistent with such program."

Applicant/Agent's Name: _____

Address: _____

Telephone: _____ Email: _____

Applicant/Agent's Signature: _____

Date: _____

Submission Requirements

For all actions requiring City Planning Commission approval, materials should be submitted to the Department of City Planning.

For local actions not requiring City Planning Commission review, the applicant or agent shall submit materials to the Lead Agency responsible for environmental review. A copy should also be sent to the Department of City Planning.

For State actions or funding, the Lead Agency responsible for environmental review should transmit its WRP consistency assessment to the Department of City Planning.

For Federal direct actions, funding, or permits applications, including Joint Applicants for Permits, the applicant or agent shall also submit a copy of this completed form along with his/her application to the [NYS Department of State Office of Planning and Development](#) and other relevant state and federal agencies. A copy of the application should be provided to the NYC Department of City Planning.

The Department of City Planning is also available for consultation and advisement regarding WRP consistency procedural matters.

New York City Department of City Planning

Waterfront and Open Space Division
120 Broadway, 31st Floor
New York, New York 10271
212-720-3525
wrp@planning.nyc.gov
www.nyc.gov/wrp

New York State Department of State

Office of Planning and Development
Suite 1010
One Commerce Place, 99 Washington Avenue
Albany, New York 12231-0001
(518) 474-6000
www.dos.ny.gov/opd/programs/consistency

Applicant Checklist

- Copy of original signed NYC Consistency Assessment Form
- Attachment with consistency assessment statements for all relevant policies
- For Joint Applications for Permits, one (1) copy of the complete application package
- Environmental Review documents
- Drawings (plans, sections, elevations), surveys, photographs, maps, or other information or materials which would support the certification of consistency and are not included in other documents submitted. All drawings should be clearly labeled and at a scale that is legible.

Blondell Commons
Explanation of Consistency with Waterfront Policies

1. Policy 1: Support and facilitate commercial and residential redevelopment in areas well-suited to such development.

Policy 1 relates to the development of new residential, commercial, and community facility uses on the waterfront in order to revitalize derelict waterfront areas. The Rezoning Area is not located directly on the waterfront but is located over 900 feet from the Hutchinson River and separated from it by an MTA train yard, an occupational training center, and several open space areas. Nevertheless, the proposed rezoning and the associated development would bring new residents, shoppers, and other visitors to the area resulting in new activity in the playground and park across Westchester Avenue from the Rezoning Area and in the nearby waterfront areas.

2. Policy 1.1: Encourage commercial and residential redevelopment in appropriate coastal zone areas.

The project site is an appropriate location for the proposed development and meets the criteria of Policy 1.1 as described below.

A. Criteria that should be considered to determine areas appropriate for reuse through public and private actions include: compatibility with the continued functioning of the designated Special Natural Waterfront Areas, the Arthur Kill Ecologically Sensitive Maritime and Industrial Area, or Significant Maritime and Industrial Areas, where applicable; the absence of unique or significant natural features or, if present, the potential for compatible development; the presence of substantial vacant or underused land; proximity to existing residential or commercial uses; the potential for strengthening upland residential or commercial areas and for opening up the waterfront to the public; transportation access; the maritime and industrial jobs potentially displaced or created; and the new opportunities created by redevelopment.

Public actions – such as property disposition, urban renewal plans, and infrastructure provision – should facilitate redevelopment of underused property to promote housing and economic development and enhance the city's tax base, subject to consideration of Policy 2, where applicable.

Relative to Policy 1.1 A., the project site is not designated as a Special Natural Waterfront Area (SNWA), as the Arthur Kill Ecologically Sensitive Maritime and Industrial Area, or as a Significant Maritime and Industrial Area (SMIA) nor is it in close proximity to any areas so designated. The Rezoning Area does not border the shoreline and is separated from it by a distance of approximately 900 feet and an area developed with an MTA train yard, an occupational training center, and several open space areas. The Rezoning Area does not contain any unique and significant natural features. The Applicant's 46,380 square foot lot is developed primarily with vehicle related uses (vehicle repair, parking, and storage). The five Non-Applicant owned Projected Development Sites are developed with vehicle related uses, office and retail space, storage space, residences, and street rights-of-way.

The Applicant proposes to develop a 9-story mixed-use building totaling 261,660 gs in size

including 228 dwelling units, 19,668 gsf of retail space, 2,024 gsf of community facility space, and 225 accessory parking spaces. The Applicant also proposes to demap a mapped but unbuilt portion of Fink Avenue that traverses the development site.

The area surrounding the Rezoning Area is characterized by a wide variety of land uses including both single and multi-family residential, mixed use (residential-commercial), commercial, manufacturing, transportation/utilities, automotive/parking, and several parks and other community facilities. The New York City Transit's (NYCT) 6-Train elevated subway line runs to the south of the Rezoning Area. The extent of the area is generally defined by a large NYCT Train Yard and the Hutchinson River Parkway, located to the east, a manufacturing district and Westchester Creek to the south, and an Amtrak/Metro-North rail right-of-way located to the north.

The projected development would add to and strengthen the surrounding mixed-use community. The development would have no impact upon public access to the waterfront as the Rezoning Area is not located along the waterfront. The development would result in the loss of approximately 10 existing jobs, and is anticipated to result in the generation of approximately 76 new retail, office, and residential service jobs on the Applicant's property. Additional jobs would be generated by new development on the Non-Applicant Owned Projected Development Sites.

The Proposed Actions would not involve any public actions, such as property disposition, Urban Renewal Plans, and infrastructure provision although the Actions would demap a mapped but unbuilt portion of Fink Avenue that traverses the development site. The Actions would facilitate redevelopment of underused property to promote housing and economic development and would thereby enhance the city's tax base.

3. Policy 1.3: Encourage redevelopment in the Coastal Zone where public facilities and infrastructure are adequate or will be developed.

A. Encourage development at a density compatible with the capacity of surrounding roadways, mass transit, and essential community services such as public schools. Lack of adequate local infrastructure need not preclude development, but it may suggest the need to upgrade or expand inadequate or deteriorated local infrastructure.

The Project Site is located in an area with fully developed infrastructure with adequate capacity to serve the proposed project. The Rezoning Area is bounded by Blondell Avenue, which provides access to areas to the north, and Westchester Avenue which provides east-west roadway access to major traffic thoroughfares including the Hutchinson River Parkway and the Bruckner Expressway to the east and the Cross Bronx Expressway to the south and west.

The Rezoning Area is approximately 0.12 miles from the Westchester Avenue/Feris Place subway station (#6 train). The Rezoning Area is also served by several bus lines along Westchester Avenue, which borders the Rezoning Area to the south, as well as along East Tremont Avenue and Williamsbridge Road one block to the west. The nearest public

elementary/middle school, P. S./I. S. 194 at 1301 Zerega Avenue serving grades Kindergarten through 8, is located approximately 1/2-mile from the Applicant's property.

4. Policy 1.5: Integrate consideration of climate change and sea level rise into the planning and design of waterfront residential and commercial development, pursuant to WRP Policy 6.2.

A. Projects should consider potential risks related to coastal flooding to features specific to each project, including, but not limited to, critical electrical and mechanical systems, residential living areas, and public access areas.

See discussion under Policy 6.2 below.

5. Policy 6: Minimize loss of life, structures, infrastructure, and natural resources caused by flooding and erosion, and increase resilience to future conditions caused by climate change.

As shown on FEMA Panel 3604970104F, effective 9/5/2007, most of the Rezoning Area is located within Zone X, which has a 0.2 percent annual chance flood hazard. Zone X is described as "Areas of 0.2% chance annual flood; areas of 1% annual chance flood with average depths of less than 1 foot or with drainage areas less than 1 square mile; and areas protected by levees with 1% chance annual flood."

A preliminary updated flood zone map was prepared in 2013 for the area containing the Rezoning Area. This map shows that nearly the entire site is now located in Zone AE which is defined as "An area inundated by 1% annual chance flooding, for which Base Flood Elevations (BFEs) have been determined."

The building does not contain a publicly accessible waterfront and is located upland from any shore. The FEMA elevation for the site is 13 feet and the required Design Flood Elevation (DFE) is 14 feet including one foot of freeboard. The lowest elevation of the proposed development would be at 3.0 feet and would consist of the cellar floor of the proposed building which would contain accessory parking spaces and storage areas. The cellar level would currently be below the current 1% annual chance floodplain height of approximately 3.5 feet, and will be below the 1% flood elevation between now and the year 2100 under all sea level rise projections. Parking will be below grade and will be wet floodproofed with openings to allow for water to leave the building after any flooding from stormwaters. Potential consequences from flooding would include minor damage to parking areas and storage areas. This could result in a temporary loss of building services, minor damage to property, and temporary displacement of resident vehicles, bicycles, and other stored items. No building mechanicals would be utilized in this area as they would be located on higher levels of the structure.

The next lowest point in the proposed development would consist of the residential entrances, the building's common areas, the retail and community facility uses, and the building mechanicals which are planned to be on the first floor at an elevation of 20 feet which would be above the required DFE of 14 feet. The entire 1st floor will be above the BFE and there will be no flood resiliency measures required for this level of the building. The building's flood resistant

construction elevation would be at 20 feet which would represent the DFE for the project. The lowest habitable residential floor would be at the second floor at an elevation of 35 feet. The first and second floors would be above the current 1% annual change flood elevation height of 13 feet and would remain above the 1% flood elevation under all projections for the year 2100, which would represent the anticipated lifespan of the project. Therefore, no flood damage would be anticipated to the residential entrances, the building's common areas, the retail and community facility uses, the building mechanicals, or the habitable residential floors under all flood projections to the year 2100.

Coastal storms could bring high winds in addition to the flood hazards described above. The site is not within a Coastal A or V zone.

In summary, the proposed project is currently within the official FEMA 1% annual chance floodplain and is required to meet NYC Building Code requirements for flood resistant construction which are further discussed below. The buildings have been designed to only locate parking and storage areas below the level of the floodplain which, if exposed to flood waters, would result in minimal damage to the buildings and their operations. No dwelling units, residential entrances, or critical building mechanicals are proposed in the cellar level of the building.

The project would not make flooding on adjacent sites worse, nor would it conflict with other plans for flood protection on adjacent sites.

The project architect, Aufgang Architects, has provided the following responses regarding the design of the building relative to protecting the structure and its residents, workers, visitors, and natural features.

Due to the development's (preliminary) location in an AE flood zone, the proposed building on the Applicant's property has been designed to meet the requirements of the NYC Building Code in order to minimize the effect of flooding. The FEMA elevation for the site is 13 feet and the required DFE is 14 feet including one foot of freeboard. Thus, the proposed building, consistent with these regulations, will have a DFE of 20 feet. Pursuant to the Zoning Resolution, the building height is measured from the flood resistant construction elevation. Below the DFE, there may not be habitable floor area and only crawlways, parking, storage, and building access are allowed. As a result of these regulations, the cellar floor of the building will be used for required parking and for bicycle storage. Additionally, the boiler equipment and other mechanical and electric and gas systems will be located on the first floor of the building and above at a minimum elevation of 20 feet. The existing grades on the site range from 20 feet at the sidewalk to approximately 8 feet at the rear of the property (see attached Property Survey).

The residential entrances, the building's common areas, the retail and community facility uses, and the building mechanicals are planned to be on the first floor at an elevation of 20 feet which would be at the building's DFE of 20'. The lowest residential floors would be at an elevation of 35 feet. The parking and storage areas will be in the cellar level of the building at an elevation of 3 feet and will be wet/unprotected. The development will be landscaped with salt water proof plantings.

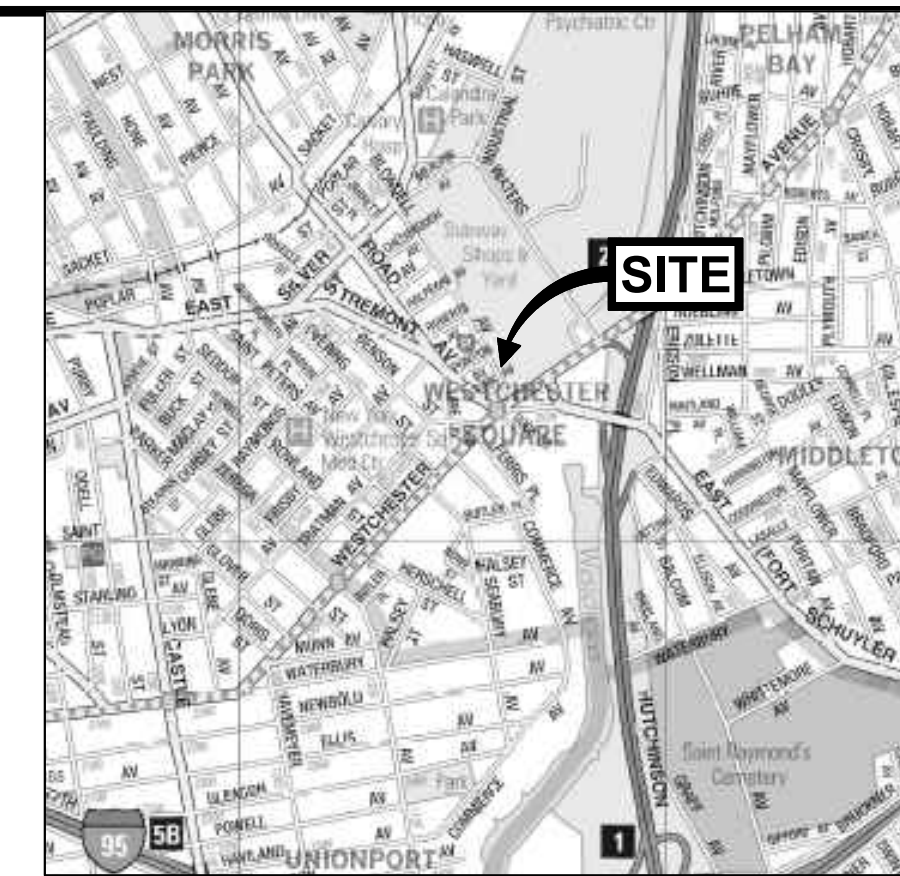

VICINITY MAP
© 2004 DeLorme Street Atlas USA

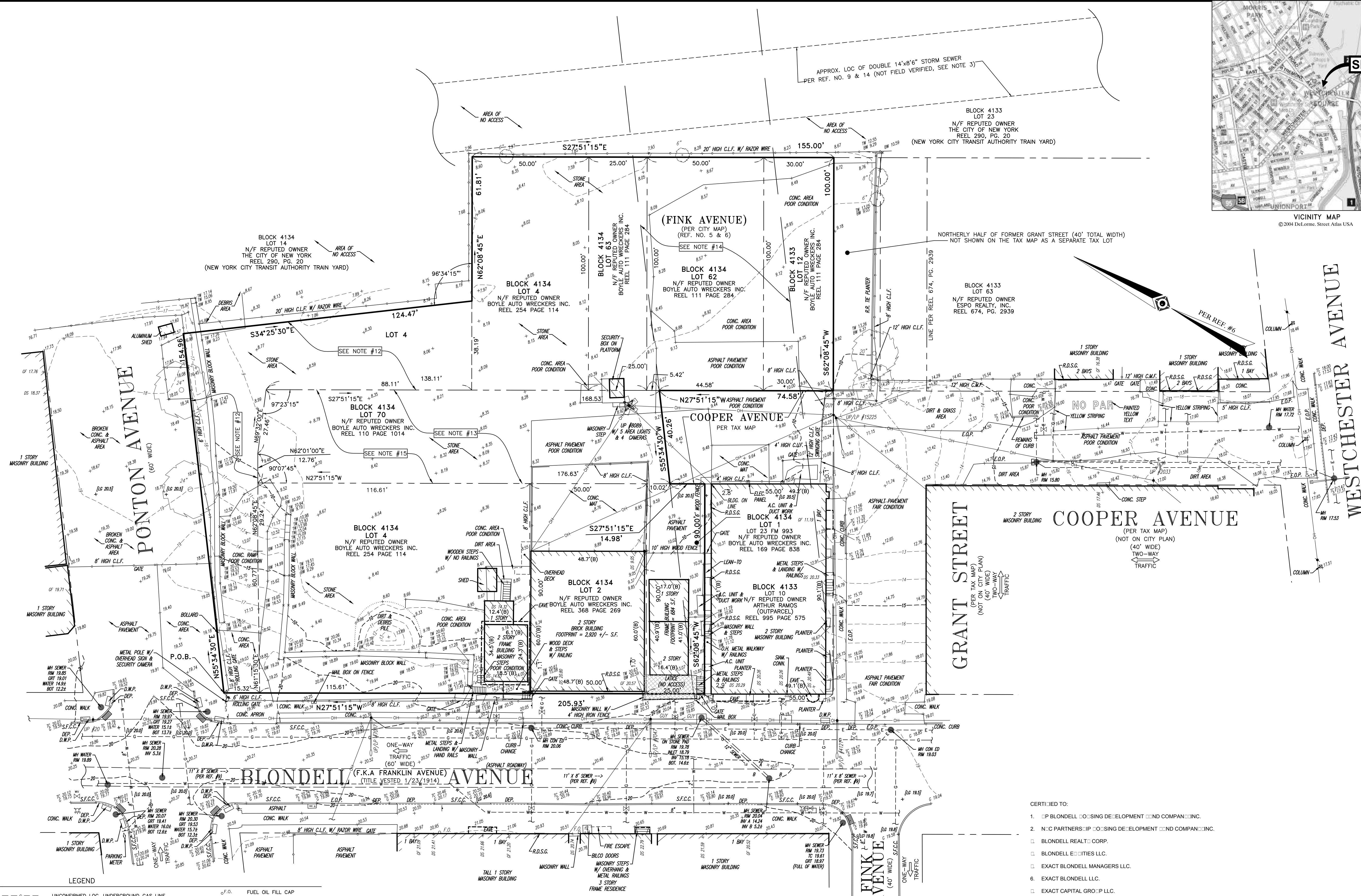

CONTROL POINT ASSOCIATES, INC. - ALL RIGHTS RESERVED. THIS DOCUMENT IS THE PROPERTY OF CONTROL POINT ASSOCIATES, INC. AND IS NOT TO BE REPRODUCED OR TRANSMITTED IN ANY FORM OR BY ANY MEANS, ELECTRONIC OR MECHANICAL, INCLUDING PHOTOCOPYING, RECORDING, OR BY ANY INFORMATION STORAGE AND RETRIEVAL SYSTEM.

LEGEND	
--- 123 ---	EXISTING CONTOUR
x 123.45	EXISTING SPOT ELEVATION
x TC 123.45	EXIST. TOP OF CURB ELEVATION
x G 123.45	EXIST. GUTTER ELEVATION
x TW 123.45	EXIST. TOP OF WALL ELEVATION
x BW 123.45	EXIST. BOTTOM OF WALL ELEVATION
x DS 123.45	EXIST. DOOR SILL ELEVATION
x GF 123.45	EXIST. GARAGE FLOOR ELEVATION
x [LG 123.45]	LEGAL GRADE PER REF. #7 & #8
(B)	TITLE REPORT EXCEPTION
○	TREE W/ TRUNK DIAMETER
○	OFFSET OF STRUCTURE AT GROUND LEVEL RELATIVE TO PROPERTY LINE
(B)	EXTERIOR DIMENSION OF BUILDING
---	UNCONFIRMED LOC. UNDERGROUND GAS LINE PER REF. #11 & UTILITY MARKOUT
---	UNCONFIRMED LOC. UNDERGROUND ELEC. LINE PER REF. #12 & #13 (NOT FIELD VERIFIED, SEE NOTE #3)
---	UNCONFIRMED LOC. & SIZE UNDERGROUND WATER LINE PER REF. #10 (NOT FIELD VERIFIED, SEE NOTE #3)
OH	OVERHEAD WIRES
U.P.	UTILITY POLE
U.P./L.P.	UTILITY POLE/LIGHT POLE
G.W.	GUY WIRE
SL	STREET LIGHT
AL	AREA LIGHT
WV	WATER VALVE
GV	GAS VALVE
F.O.	FUEL OIL FILL CAP
M.P.	METAL POST
S	SIGN
C.L.F.	CHAIN LINK FENCE
C.M.F.	CORRUGATED METAL FENCE
DEP.	DEPRESSED CURB
D.W.P.	DETECTABLE WARNING PAD
E.O.C.	EDGE OF CONC.
E.O.P.	EDGE OF PAVEMENT
R.D.S.G.	ROLL DOWN SECURITY GATE
PA	PAINTED ARROWS
EP	ELECTRIC PANEL
H	HYDRANT
TL	DENOTES TAX LOT LINE

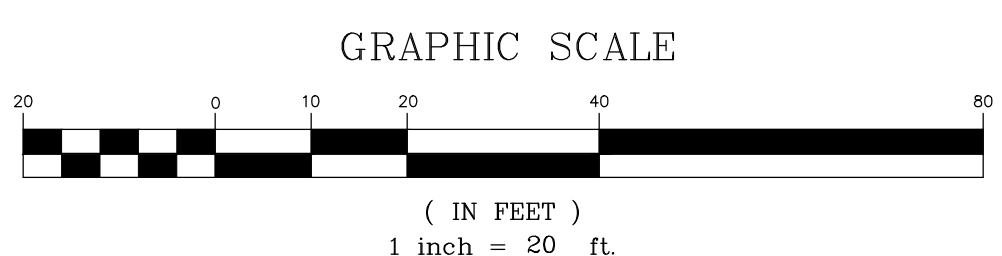

NOT A VALID ORIGINAL DOCUMENT UNLESS EMBOSSED WITH BLUE INK SEAL.
 THIS IS TO CERTIFY THAT THIS MAP OR PLAN AND THE SURVEY ON WHICH IT WAS BASED WERE MADE IN ACCORDANCE WITH THE 2011 MINIMUM STANDARD DETAIL REQUIREMENTS ON ALTA/ACSM LAND TITLE SURVEYS, ESTABLISHED AND ADOPTED BY ALTA AND NSPS, AND INCLUDES ITEMS 2, 6, 8, 10, 11, 12, 13, 14, 15, 16, 17, 18, 19, 20, 21, 22, 23, 24, 25, 26, 27, 28, 29, 30, 31, 32, 33, 34, 35, 36, 37, 38, 39, 40, 41, 42, 43, 44, 45, 46, 47, 48, 49, 50, 51, 52, 53, 54, 55, 56, 57, 58, 59, 60, 61, 62, 63, 64, 65, 66, 67, 68, 69, 70, 71, 72, 73, 74, 75, 76, 77, 78, 79, 80, 81, 82, 83, 84, 85, 86, 87, 88, 89, 90, 91, 92, 93, 94, 95, 96, 97, 98, 99, 100. TABLE A TERE. THE FIELD WORK WAS COMPLETED ON 11-20-11.

CERTIFIED TO:

- OP BLONDELL; OSING DEVELOPMENT; OND COMPAN; OINC.
- NO; CP PARTNERS; IP; OSING DEVELOPMENT; OND COMPAN; OINC.
- BLONDELL REALTY; CORP.
- BLONDELL REALTY; LLC.
- EXACT BLONDELL MANAGERS LLC.
- EXACT BLONDELL LLC.
- EXACT CAPITAL GROUP LLC.
- RA-A DEVELOPMENT; OND.

SEE SHEET 2 OF 2 FOR NOTES AND REFERENCES

FIELD DATE	11-20-11	ALTA/ACSM LAND TITLE SURVEY
FIELD BOOK NO.	0000	VAN ZANDT AGENCY
FIELD BOOK PG.	0000	LOT 12; BLOCK 4133
DRAWN	W.P.B.	LOTS 1, 2, 3, 4, 5, 6, 7, 8, 9, 10, 11, 12, 13, 14, 15, 16, 17, 18, 19, 20, 21, 22, 23, 24, 25, 26, 27, 28, 29, 30, 31, 32, 33, 34, 35, 36, 37, 38, 39, 40, 41, 42, 43, 44, 45, 46, 47, 48, 49, 50, 51, 52, 53, 54, 55, 56, 57, 58, 59, 60, 61, 62, 63, 64, 65, 66, 67, 68, 69, 70, 71, 72, 73, 74, 75, 76, 77, 78, 79, 80, 81, 82, 83, 84, 85, 86, 87, 88, 89, 90, 91, 92, 93, 94, 95, 96, 97, 98, 99, 100
REVIEWED	A.P.W.	BOROUGH AND COUNTY OF BRONX CITY AND STATE OF NEW YORK
APPROVED	J.C.W.	DATE
DATE	12-01-2011	SCALE
FILE NO.	C060002	DWG NO.
DWG NO.	1	2

CONTROL POINT ASSOCIATES, INC. MANHATTAN, NY 646.780.0411
 352 TURNPIKE ROAD MT. LAUREL, NJ 609.857.2099
 SOUTHBOROUGH, MA 01772 CHALFANT, PA 215.712.8800
 508.948.3000 - 508.948.3003 FAX WARREN, NJ 908.668.0099

JAMES C. WEED
 NEW YORK PROFESSIONAL LAND SURVEYOR NO. 63

NOTES:

- 1. PROPERTY KNOWN AS LOT 12 BLOCK 1 LOTS 1 & 2...
2. AREA OF LOT 12 BLOCK 1...
3. LOCATION OF UNDERGROUND UTILITIES ARE APPROXIMATE...
4. THIS PLAN IS BASED ON INFORMATION PROVIDED BY A SURVEY PREPARED IN THE FIELD...
5. THIS SURVEY WAS PREPARED WITH REFERENCE TO A TITLE REPORT PREPARED BY CLEAR NATIONAL TITLE AS AGENT...
6. BIRGRAPIC PLOTTING ONLY PROPERTY IS LOCATED IN FLOOD HAZARD ONE B AREAS...
7. THE EXISTENCE OF UNDERGROUND STORAGE TANKS WAS NOT KNOWN AT THE TIME OF THE FIELD SURVEY...
8. ELEVATIONS ARE BASED UPON THE BORO OF BRONX HIGHWAY DATUM...
9. THERE WERE NO NATURAL STREAMS OR WATERCOURSES VISIBLE AT THE TIME OF THE FIELD SURVEY...
10. ENCROACHMENTS AND ENCLOSURES BELOW SURFACE NOT SHOWN HEREON...
11. THERE WAS NO OBSERVED EVIDENCE OF CURRENT EARTH MOVING WORK BUILDING CONSTRUCTION OR BUILDING ADDITIONS AT THE TIME OF SURVEY...
12. THERE WAS NO OBSERVED EVIDENCE OF SITE USE AS A SOLID WASTE DUMP OR SANITARY LANDFILL AT THE TIME OF SURVEY...
13. THERE WAS NO OBSERVED EVIDENCE OF LOCATION OF WETLAND AREAS AS DELINEATED BY APPROPRIATE AUTHORITIES...
14. CURRENT ZONING CLASSIFICATION NOT PROVIDED BY AT TIME OF SURVEY...

REFERENCES:

- 1. THE OFFICIAL TAX ASSESSORS MAP OF THE BORO OF AND COUNTY OF BRONX CITY AND STATE OF NEW YORK...
2. MAP ENTITLED 'NATIONAL FLOOD INSURANCE PROGRAM'...
3. MAP ENTITLED 'SURVEY OF PROPERTY SITUATE IN THE BORO OF AND COUNTY OF BRONX CITY AND STATE OF NEW YORK'...
4. MAP ENTITLED 'SECTION 1 BLOCKS 1 TO 100 SURVEY 2'...
5. RECORD MAP SECTION 16 PROVIDED BY THE OFFICE OF THE PRESIDENT OF THE CITY OF NEW YORK...
6. MAP ENTITLED 'MAP OR PLAN OF SECTION 14 S.O.G.S.'...
7. AMENDED MAP OF SECTION 16 PROVIDED BY THE OFFICE OF THE PRESIDENT OF THE CITY OF NEW YORK...
8. AMENDED SECTION 14 PROVIDED BY THE OFFICE OF THE PRESIDENT OF THE CITY OF NEW YORK...
9. PLANS SHOWING THE LOCATION OF UNDERGROUND SEWER FACILITIES...
10. PLANS SHOWING THE LOCATION OF UNDERGROUND WATER FACILITIES...
11. GAS MAINS AND SERVICE PLATES PROVIDED BY CONSOLIDATED EDISON CO. OF N.Y. - BRONX PLATE NO. 10-W LAST MODIFIED 10-2-2000...

SCHEDULE "A" LEGAL DESCRIPTION

BLOCK 4134 LOT 1:

ALL THAT CERTAIN PLOT/PIECE OR PARCEL OF LAND SITUATE LING AND BEING IN THE BORO OF AND COUNTY OF BRONX CITY AND STATE OF NEW YORK...
BEGINNING AT A POINT ON THE EASTERLY SIDE OF BLONDELL AVENUE 60 FEET WIDE...
TENCE NORTHWARD AT RIGHT ANGLES TO THE LAST MENTIONED LINE 2 FEET TO A POINT...
TENCE WESTERLY AT RIGHT ANGLES TO THE LAST MENTIONED COURSE 10 FEET TO THE EASTERLY SIDE OF THE AFORESAID BLONDELL AVENUE AND...
TENCE SOUTHWARD ALONG SAID BLONDELL AVENUE AND AT RIGHT ANGLES WITH THE LAST MENTIONED COURSE 2 FEET TO THE POINT OR PLACE OF BEGINNING.

SCHEDULE "A" LEGAL DESCRIPTION

BLOCK 4134 LOT 2,3

ALL THAT CERTAIN PLOT/PIECE OR PARCEL OF LAND SITUATE LING AND BEING IN THE BORO OF AND COUNTY OF BRONX CITY AND STATE OF NEW YORK...
BEGINNING AT A POINT ON THE EASTERLY SIDE OF BLONDELL AVENUE DISTANT 1.0 FEET SOUTHWARD FROM THE CORNER FORMED BY THE INTERSECTION OF THE EASTERLY SIDE OF BLONDELL AVENUE WITH THE SOUTHWARDLY SIDE OF PONTON COOPER AVENUE...
RUNNING TENCE EASTWARD ALONG THE SOUTHWARDLY SIDE OF PONTON AVENUE NOT LEGALLY OPENED 16 FEET...
TENCE SOUTHWARD AT RIGHT ANGLES TO THE LAST DESCRIBED COURSE 12 FEET...
TENCE EASTWARD ON A LINE FORMING AN ANGLE OF 6 DEGREES 11 MINUTES 10 SECONDS EAST 61 FEET...
TENCE SOUTHWARD AT RIGHT ANGLES TO THE LAST MENTIONED COURSE 10 FEET...
TENCE WESTWARD ON A LINE AT RIGHT ANGLES TO THE LAST MENTIONED COURSE ALONG THE SOUTHWARDLY SIDE OF TAX LOT 6 100 FEET...
TENCE NORTHWESTWARD AT RIGHT ANGLES TO THE LAST MENTIONED COURSE 11 FEET TO A POINT...
TENCE WESTWARD ON A LINE FORMING AN ANGLE WITH THE LAST MENTIONED COURSE OF 2 DEGREES 21 MINUTES 1 SECONDS 2.6 FEET TO A POINT...
TENCE SOUTHWESTWARD TO THE LAST MENTIONED COURSE AT AN ANGLE OF 11 DEGREES 14 MINUTES 00 SECONDS 12.6 FEET CONTINUING...
TENCE SOUTHWARD ON A LINE FORMING AN ANGLE WITH THE LAST MENTIONED COURSE OF 10 DEGREES 0 MINUTES 22 SECONDS 116.61 FEET...
TENCE ON A LINE AT RIGHT ANGLES TO THE LAST MENTIONED COURSE 10 DEGREES TO THE EASTERLY SIDE OF BLONDELL AVENUE...
TENCE NORTHWARD AT RIGHT ANGLES TO THE LAST MENTIONED COURSE ALONG THE EASTERLY SIDE OF BLONDELL AVENUE 10 FEET TO THE POINT OR PLACE OF BEGINNING.

SCHEDULE "A" LEGAL DESCRIPTION

BLOCK 4134 LOT 4:

ALL THAT CERTAIN PLOT/PIECE OR PARCEL OF LAND SITUATE LING AND BEING IN THE BORO OF AND COUNTY OF BRONX CITY AND STATE OF NEW YORK...
BEGINNING AT A POINT AT THE INTERSECTION OF THE EASTERLY LINE OF BLONDELL AVENUE WITH THE SOUTHWARDLY LINE OF PONTON COOPER AVENUE AND...
RUNNING TENCE EASTWARD ALONG THE SOUTHWARDLY LINE OF PONTON AVENUE NOT LEGALLY OPENED 16 FEET...
TENCE SOUTHWARD AT RIGHT ANGLES TO THE LAST DESCRIBED COURSE 12 FEET...
TENCE EASTWARD ON A LINE FORMING AN ANGLE OF 6 DEGREES 11 MINUTES 10 SECONDS EAST 61 FEET...
TENCE SOUTHWARD AT RIGHT ANGLES TO THE LAST MENTIONED COURSE 10 FEET...
TENCE WESTWARD ON A LINE AT RIGHT ANGLES TO THE LAST MENTIONED COURSE ALONG THE SOUTHWARDLY SIDE OF TAX LOT 6 100 FEET...
TENCE NORTHWESTWARD AT RIGHT ANGLES TO THE LAST MENTIONED COURSE 11 FEET TO A POINT...
TENCE WESTWARD ON A LINE FORMING AN ANGLE WITH THE LAST MENTIONED COURSE OF 2 DEGREES 21 MINUTES 1 SECONDS 2.6 FEET TO A POINT...
TENCE SOUTHWESTWARD TO THE LAST MENTIONED COURSE AT AN ANGLE OF 11 DEGREES 14 MINUTES 00 SECONDS 12.6 FEET CONTINUING...
TENCE SOUTHWARD ON A LINE FORMING AN ANGLE WITH THE LAST MENTIONED COURSE OF 10 DEGREES 0 MINUTES 22 SECONDS 116.61 FEET...
TENCE ON A LINE AT RIGHT ANGLES TO THE LAST MENTIONED COURSE 10 DEGREES TO THE EASTERLY SIDE OF BLONDELL AVENUE...
TENCE NORTHWARD AT RIGHT ANGLES TO THE LAST MENTIONED COURSE ALONG THE EASTERLY LINE OF BLONDELL AVENUE 10 FEET TO THE POINT OR PLACE OF BEGINNING.

SCHEDULE "A" LEGAL DESCRIPTION

BLOCK 4134 LOT 70:

ALL THAT CERTAIN PLOT/PIECE OR PARCEL OF LAND SITUATE LING AND BEING IN THE BORO OF AND COUNTY OF BRONX CITY AND STATE OF NEW YORK DESIGNATED ON THE TAX MAP OF THE CITY OF NEW YORK AS SECTION 12 BLOCK 1 LOT 70.

SCHEDULE "A" LEGAL DESCRIPTION

BLOCK 1 LOTS 62 & 63 AND BLOCK 1 LOT 12:

ALL THAT CERTAIN PLOT/PIECE OR PARCEL OF LAND SITUATE LING AND BEING IN THE BORO OF AND COUNTY OF BRONX CITY AND STATE OF NEW YORK...
MAP OF PROPERTY OF WILLIAM COOPER DECEASED...
SITUATED IN THE TOWN OF WESTCHESTER COUNTY OF WESTCHESTER N.Y. BY JAMES E. SERRELL & SONS...
WESTCHESTER ON A G.S.T. 111 AS MAP NO. 111 W.I.C. SAID LOTS TAKEN TOGETHER ARE BOUND AND DESCRIBED AS FOLLOWS:

WESTERLY IN FRONT OF COOPER AVENUE AS LAID DOWN ON SAID MAP 10 FEET...
NORTHERLY BY LOT NO. 12 AS LAID DOWN ON SAID MAP 100 FEET...
EASTERLY BY LOT NO. 12 AS LAID DOWN ON SAID MAP 10 FEET AND...
SOUTHERLY BY GRANT STREET AS LAID DOWN ON SAID MAP 100 FEET.

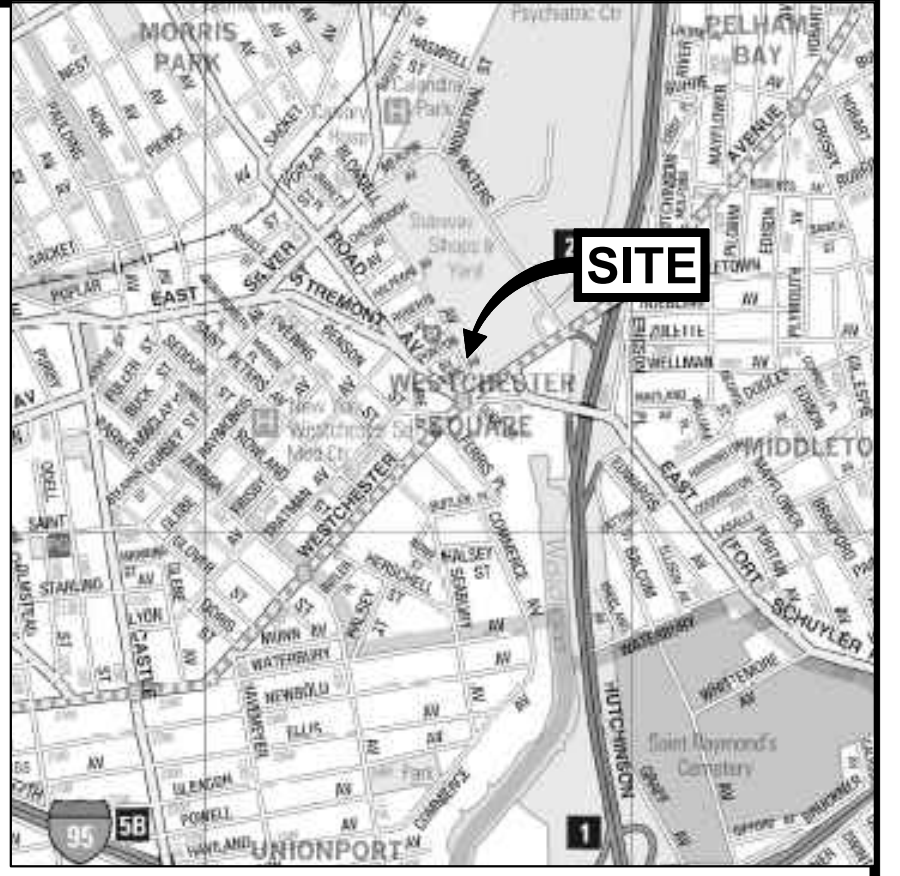

VICINITY MAP © 2004 DeLorme Street Atlas USA

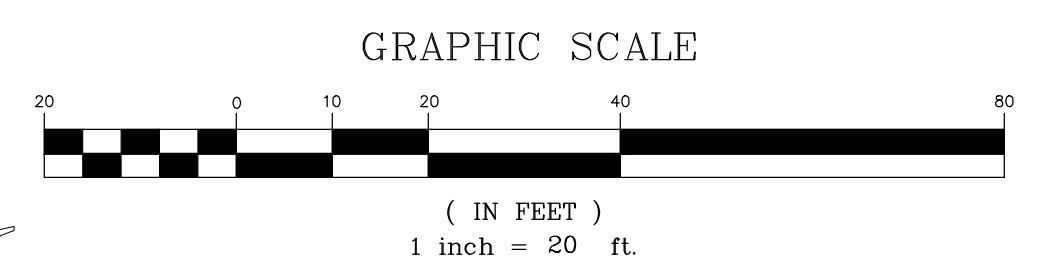

NOT A VALID ORIGINAL ALTERATION OR ADDITION TO A SURVEY MAP BEARING A LICENSED LAND SURVEYORS SEAL IS A VIOLATION OF SECTION 20-B-DIVISION 2 OF THE NEW YORK STATE EDUCATION LAW.
ONLY COPIES FROM THE ORIGINAL THIS SURVEY MARKED WITH AN ORIGINAL OF THE LAND SURVEYORS EMBOSSED SEAL SHALL BE CONSIDERED TO BE VALID TRUE COPIES.

- CERTIFIED TO:
1. BLONDELL DEVELOPING DEVELOPMENT COMPANY INC.
2. NYC PARTNERSHIP DEVELOPING DEVELOPMENT COMPANY INC.
BLONDELL REALTY CORP.
BLONDELL ESTATES LLC.
EXACT BLONDELL MANAGERS LLC.
EXACT BLONDELL LLC.
EXACT CAPITAL GROUP LLC.
RA DEVELOPMENT LTD.

Table with survey details: FIELD DATE 11-20-11, ALTA/ACSM LAND TITLE SURVEY, VAN ZANDT AGENCY, LOT 12 BLOCK 1 LOTS 1 & 2, BORO OF AND COUNTY OF BRONX CITY AND STATE OF NEW YORK, CONTROL POINT ASSOCIATES, INC., JAMES C. WEED, DATE 12-0-2011.

CONTROL POINT ASSOCIATES, INC. - ALL RIGHTS RESERVED. THIS IS A PROFESSIONAL SURVEYING AND MAPPING PRODUCT. THE USER ASSUMES ALL LIABILITY FOR THE USE OF THIS PRODUCT. CONTROL POINT ASSOCIATES, INC. IS NOT RESPONSIBLE FOR ANY ERRORS OR OMISSIONS.

Measures employed by the project to minimize loss of life, structures, infrastructure, and natural resources caused by flooding and erosion, and to increase resilience to future conditions caused by climate change are discussed in further detail under Policy 6.2 below.

6. Policy 6.1: Minimize losses from flooding and erosion by employing non-structural and structural management measures appropriate to the site, the use of the property to be protected, and the surrounding area.

Policy 6.1 primarily relates to shoreline protection measures. As the Project Site is not located on the shoreline and is separated from the Hutchinson River by a distance of over 900 feet and an area developed with an MTA train yard, an occupational training center, and several open space areas, shoreline protection measures would not be applicable to the subject property.

7. Policy 6.2: Integrate consideration of the latest New York City projections of climate change and sea level rise (as published by the NPCC, or any successor thereof) into the planning and design of projects in the city's Coastal Zone.

A. In the planning and design of all projects – except for the maintenance or in-kind, in-place replacement of existing facilities – identify the potential vulnerabilities of the project to sea level rise, coastal flooding, and storm surge over its usable life and the general consequences to the project of these types of events. This analysis shall be conducted by an engineer, architect or other qualified professional. For projects with a usable life span beyond the timeframe of any available projections, the furthest projection by the NPCC or its successor shall be used. The scope of the analysis should take into account the nature of the action subject to consistency review, as well as the size and location of the project, and must examine, as applicable:

The project architect, Aufgang Architects, has provided the responses below.

- *Current conditions and the projected conditions with sea level rise and climate change.*
The project is located beyond 900 feet of the nearest existing shoreline (Hutchinson River). An MTA train yard, an occupational training center, several open space areas, and Westchester Avenue and several local streets serve as a buffer between the Applicant's projected development site and the Hutchinson River.
- *Features of the project likely to be vulnerable to temporary flooding, frequent inundation, wave action, or erosion. Vulnerable features may include, for example, residential living areas, workplace areas, public access areas, plants and materials, critical electrical and mechanical systems, temporary and long-term waste storage areas, fuel storage tanks, energy generators, hazardous materials storage, or maritime infrastructure.*

All proposed residential uses will be located on the 2nd floor of the buildings and above. The ground floor of the building will be used for building amenities, retail and community facility space, parking ramps and for the building lobby and entrances. The boiler equipment and other mechanical and electric and gas systems will be located on the first floor of the building and above at a minimum elevation of 20 feet. The residential entrances, the building's common areas, the retail and community facility uses, and the building mechanicals are planned to be on the first floor at an elevation of 20 feet which would be at the building's DFE of 20 feet. The lowest residential floors would be at an elevation of 35 feet. The parking and storage areas will

be in the cellar level of the building at an elevation of 3 feet and will be wet/unprotected. Parking and storage will be located in a wet floodproofed level of the building. Storage and parking are the only permitted uses in a wet floodproofed area. The development will be landscaped with salt water proof plantings.

- *The general consequences of temporary flooding, frequent inundation, wave action, or erosion with respect to such vulnerable features.*

The building will be constructed on piles and will not be susceptible to wave action or flooding.

- *The best available flood zones as established by FEMA, any associated base flood elevation, and the range of the projected future flood elevations based on sea level rise projections, as available.*

The project was designed to be above flood plain level.

B. Identify and incorporate design techniques in projects that address the potential vulnerabilities and consequences identified and/or enhance the capacity to incorporate adaptive techniques in the future. Climate resilience techniques shall aim to protect health and well-being, minimize damage to systems and natural resources, prevent loss of property, and, to the extent practicable, promote economic growth and provide additional benefits such as the provision of public space or intertidal habitat. The appropriate techniques for a given project depend on case-by-case considerations, including such factors as the project's lifespan, the costs, benefits, and feasibility of incorporating a technique, and the potential adverse or positive effects of the techniques on ecological health, public health, urban design, economic activity, and public space. To the extent that potential techniques are identified but not incorporated, an explanation shall be provided as to why incorporating such techniques are not appropriate or practicable for the given project, or how the project may be adapted to incorporate such measures in the future. The following are examples of potential techniques to be considered and incorporated into the project design, as appropriate:

- *Features which increase the project's ability to withstand sea level rise, coastal flooding, and storm surge.*

These features include pile foundations for the proposed building, residential units on the 2nd floor of the building and above, and passive water drainage throughout the ground floor of the structure.

- *Openings that allow the flood waters to enter and leave without causing disruption.*

Passive water drainage will be incorporated into the design of the building.

- *Opportunities to elevate, encase, or design electrical and mechanical equipment to be submersible.*

The boiler equipment and other mechanical and electric and gas systems will be located on the first floor of the building and above at a minimum elevation of 20 feet.

- *Use of flood- and salt-water- resistant materials.*

All ground floor materials will be designed to be flood and salt water resistant.

- *Elevation of structures and usable space within a project to an appropriate design flood elevation that reduces risk with minimal impacts on public space and urban design. The selection of an appropriate design flood elevation shall consider projections of climate risks, the lifespan of the project, and specific risks associated with the project.*

The project has been elevated above flood plain level.

- *The raising of land or the placement of fill to elevate projects above projected future flood levels.*

The proposed pile foundation has been designed to elevate the building.

- *Selection of plantings suited to the current and projected future climate including selection of salt-water-tolerant species.*

The development will be landscaped with salt water proof plantings.

- *Securing, elevating, or locating outside of the flood zones hazardous materials, temporary and long-term waste storage areas, and/or fuel storage tanks to protect against the impacts of flooding and wave action due to storm surge.*

N/A

- *Incorporation of structural and non-structural shoreline treatments to attenuate waves and protect inland areas from coastal flooding.*

The Rezoning Area is not located on the shoreline.

- *Incorporation of design features that allow projects to be adapted on an on-going basis in response to changing climate projections and conditions.*

The project is elevated and buffered from any wave action or projected climate change.

C. Where opportunities exist, new structures directly on waterfront sites should incorporate site features to reduce the impacts of flooding, storm surge and wave action on inland structures and uses.

Not applicable as the Rezoning Area is not located directly on the waterfront.



 Coastal Resource Boundary



FEMA Special Flood Hazard Area (or SFHA)

Moderate to Low Risk Areas

- X < 1% ACF
- 0.2 PCT ACFH * < 1% ACF

High Risk Areas

- A 1% ACF, no base flood elevations
- AE 1% ACF, periodic base flood elevations

High Risk-Coastal Areas

- VE => 1% ACF + Storm Waves

Floodway

COBRA **

Open Water

* 0.2% Annual Chance of Flood Hazard
 ** Coastal Barrier Resources System Area
 ACF = Annual Chance of Flooding

Note: The current map does not cover changes made after Hurricane Sandy.

After Hurricane Sandy - FEMA ABFE Zones

FEMA Advisory Flood Hazard Zones:

Low/Moderate Risk

- Advisory Zone X < 1%ACF*

High Risk Areas

- Advisory Zone A 1%ACF

High Risk-Coastal Areas

- Advisory Zone V 1%ACF

Area of Moderate Wave Action **

CBRA Zones***

1%EL = 1% Advisory Base Flood Elevation
 0.2%EL = 0.2% Advisory Base Flood Elevation

* Annual Chance of Flood Hazard
 ** Wave Hights between 1.5 and 3 feet
 *** Coastal Barrier Resource Act

Source: Federal Emergency Management Agency (fema.gov) / PropertyShark.com

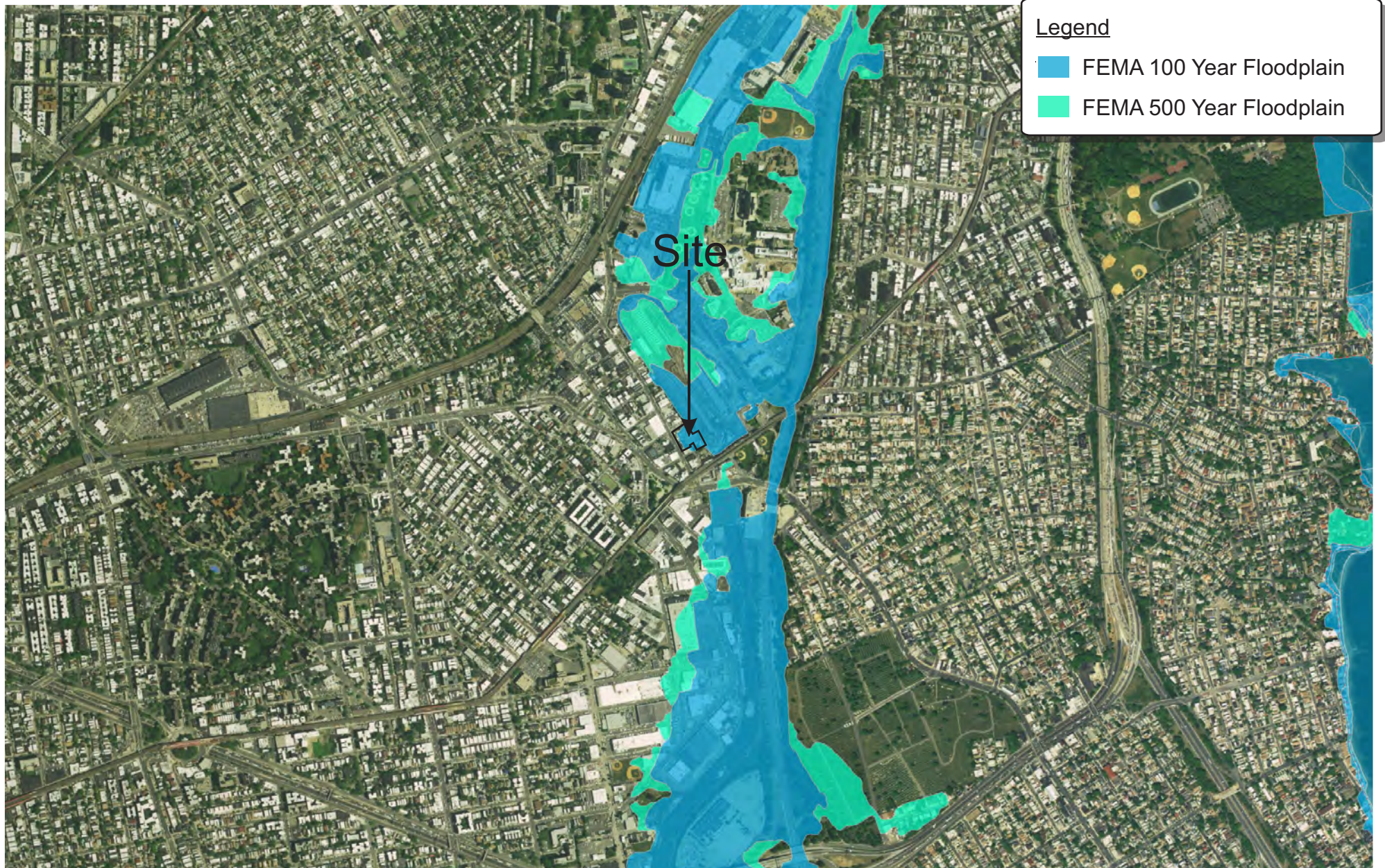

Legend

- FEMA 100 Year Floodplain
- FEMA 500 Year Floodplain

Source: Preliminary 2015 FIRMs, Federal Emergency Management Agency (fema.gov)

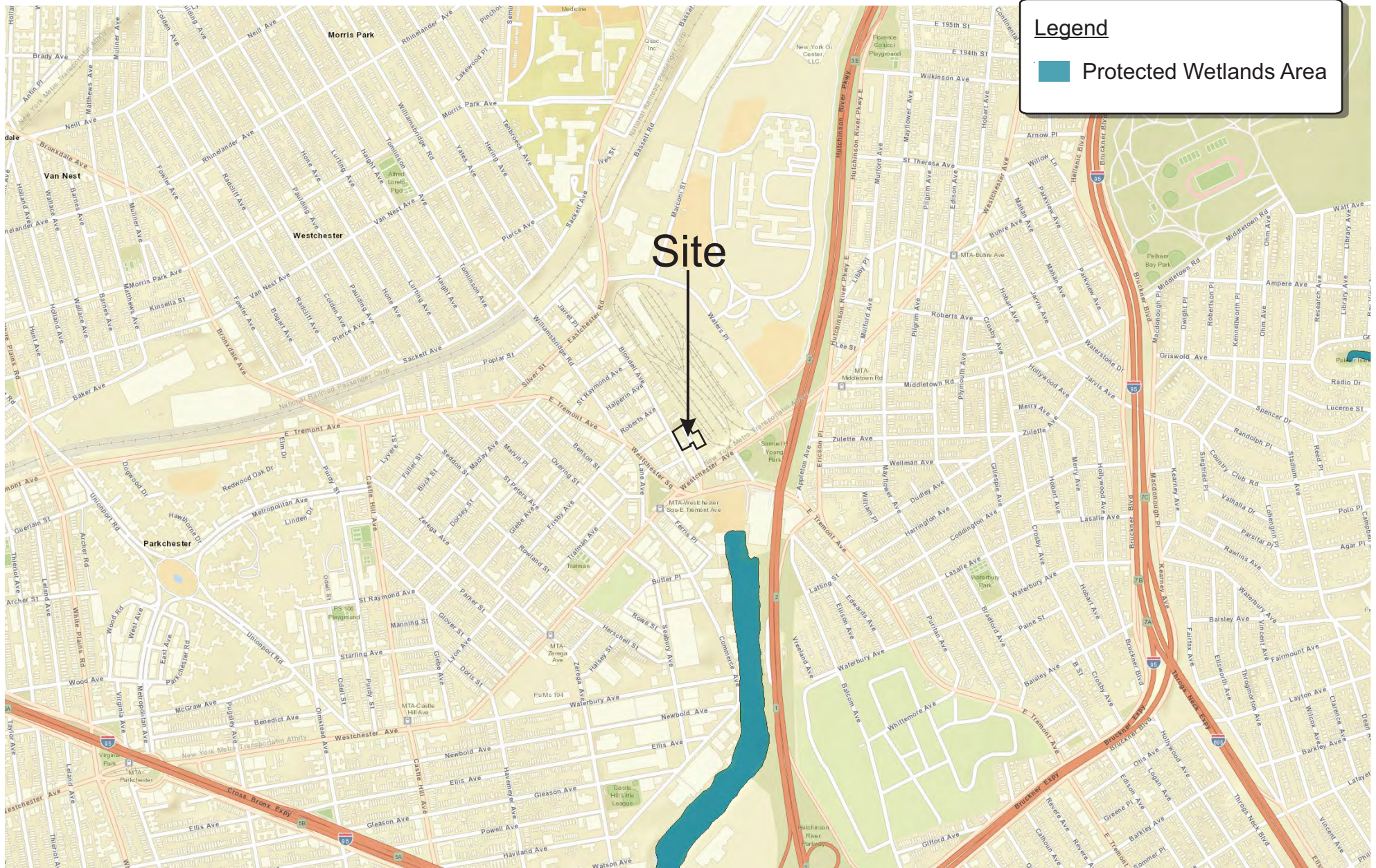

Source: U.S. Fish and Wildlife Service (fws.gov)

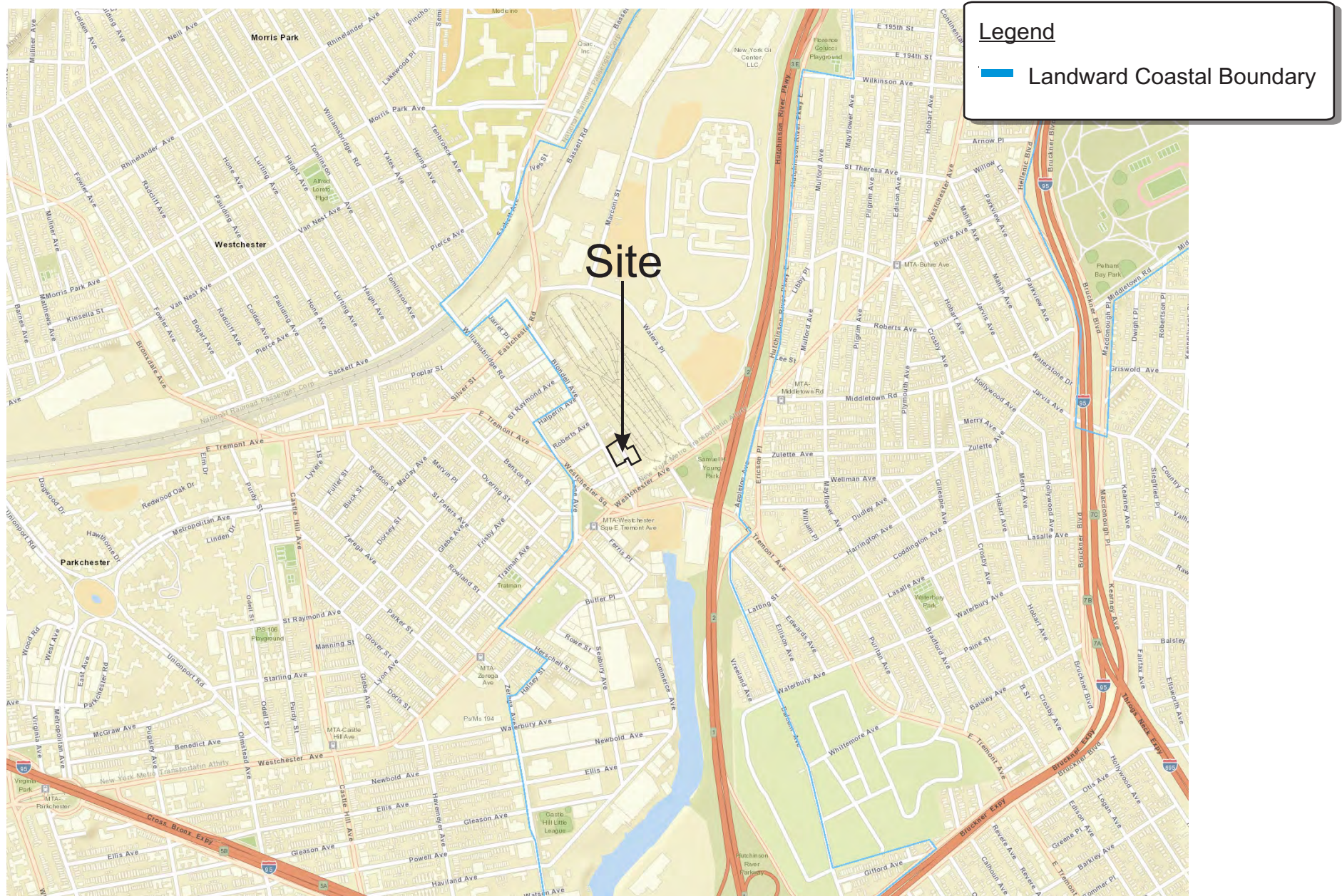

Source: NYS DOS Office of Communities and Waterfronts (dos.ny.gov)

5. SOCIOECONOMIC CONDITIONS

The Proposed Actions would involve a rezoning of the Applicant's property and Non-Applicant properties, as well as a demapping adjacent to the Rezoning Area. The Proposed Actions consist of a Zoning Map Amendment from M1-1 to R7A/C2-4 and a Zoning Text Amendment to modify ZR §23-933, Appendix F to designate the newly mapped R7A/C2-4 district as a Mandatory Inclusionary Housing (MIHA) designated area. The Proposed Actions also include a demapping of Fink Avenue between Blondell and Waters Avenues.

Under the Reasonable Worst-Case Development Scenario (RWCDS), the Proposed Actions are anticipated to result in the development of 384 new dwelling units, 260 of which are proposed to be affordable units, 48,729 gsf of commercial retail/office space, and 2,024 gsf of community facility space (day care center and medical offices). As approved by HPD, 227 of the 228 units on the Applicant Owned property would be considered affordable with 65% or 148 units at 80% of AMI or less and 35% or 79 units at 100% AMI or less as approved by HPD. One dwelling unit would be provided for the building superintendent and is not included in the affordability breakdown. The required zoning text amendment to make the area applicable to MIH would require at least 20% of the proposed residential floor area on the non-Applicant owned Projected Development Sites to be reserved for incomes averaging 80% AMI, resulting in the development of 33 affordable units. For the purposes of the socioeconomics analysis, it is assumed that 260 dwelling units would be considered affordable, with 181 units affordable at 80% of AMI or less.

The Proposed Actions and resulting development would not result in the direct loss of 500 residents but would add approximately 384 new dwelling units (4 existing units would be displaced for a net increase of 380 dwelling units). The With-Action RWCDS would also result in the development of approximately 48,729 gsf of new commercial retail space and 2,024 square feet of community facility use (a net increase of 9,025 gsf of commercial retail/office space and 2,024 gsf of community facility space). This is less than the *CEQR Technical Manual* threshold of 200,000 square foot for consideration of indirect business displacement. Furthermore, the Proposed Actions are not anticipated to directly displace 100 employees, as the Sites proposed to be redeveloped consist of 39,704 gsf of office and retail space and 6,775 gsf of storage and automobile related uses. Even under a conservative estimate of one employee per 425 gsf of space for office/retail uses and one employee per 1,000 square feet for storage and automotive uses, less than 100 employees would be displaced. Table 5-1 provides a list of all the existing businesses and residents on the Projected Development Sites including block and lot, address, name of the business, type of business, approximately how many people the business employs, and the number of dwelling units. No further analysis is required for direct residential, direct business, or indirect business displacement.

Table 5-1
Existing Development on Projected Development Sites

Proj Devel Site #	Block/Lot	Address	Name of Business	Description of Use	No. of Employees
1	B 4134, L 1	1340 Blondell Ave	Caveman Cycles; Darkside Collision + Tow	auto body repair; vehicle towing parking, storage, & access offices; one 1-family DU (abandoned); street right-of-way	15
2	B 4133, L 1	2601 Westchester Ave	B & L Auto Repair	automobile repair and storage	15
3	B 4133, L 2	1312 Blondell Ave	HCS Tax Services	office space & garage	10
4	B 4133, L 63	1306 Cooper Ave	Elsaja Cooper LLC	warehouse/storage building	1
5	B 4133, L 10	1332 Blondell Ave	Side Street Lounge	1 nightclub; 4 DUs	10
6	B 4133, L 61, 62	2611 Westchester Ave, 1314 Cooper Ave	Westchester Bicycle Pro Shop; Horn Al & Sons Bakery Equip Corp	Office space and retail stores	30

The Proposed Actions could potentially generate a net increase of 380 residential units, as compared to the No Build condition. This would exceed the 200 unit threshold established for further assessment of potential indirect residential displacement. Therefore, the following provides a preliminary assessment of the potential for the Proposed Actions to result in any significant adverse impacts related to indirect residential displacement.

Indirect Residential Displacement

As indicated in the *CEQR Technical Manual*, “the objective of the indirect residential displacement analysis is to determine whether the proposed project may either introduce a trend or accelerate a trend of changing socioeconomic conditions that may potentially displace a vulnerable population to the extent that the socioeconomic character of the neighborhood would change.” The risk of indirect residential displacement is typically associated with rising rents caused by new higher-income housing that may contribute to increased area housing costs to an extent that could potentially force lower-income residents out of the neighborhood. The potential for impact is generally limited to households in unprotected, private rental units.

The With-Action RWCDs includes the development of 384 dwelling units of housing and the displacement of four existing units. No new residential development is

anticipated to occur under the No-Action RWCDs. Therefore, the Proposed Action would result in the development of a net increase of 380 dwelling units. Based on census data, the average household size is 2.87 persons per dwelling unit in the Census Tracts located within immediate 1/4-mile radius of the Rezoning Area¹. The development of 380 dwelling units would therefore be expected to generate approximately 1,091 new residents in the Rezoning Area.

Table 5-2: 1/2 Mile Study Area Population

Census Tract	Total Population
96	2,562
200	4,722
202	2,232
204	3,131
256	1,831
264	5,842
284	740
Study Area Total (2015)*	21,060
2015-2029 Increase (0.5%/year)	1,474
No-Action Population (2029)	22,534
With-Action Population (2029)	23,625

*US Census, ACS Demographic and Housing Estimates 2011-2015

Currently, the seven census tracts that are within 50 percent of the 1/2 mile area surrounding the Rezoning Area contain 21,060 residents (See Table 5-2), according to 2015 Census data estimates. In order to account for background growth to the 2029 project analysis year, a conservative annual growth rate of 0.5% per year was applied to the 2015 population of the 1/2-mile study area. This growth factor would result in the addition of 1,474 additional residents. Therefore, as projected to 2029, the base population is projected to be 22,534 residents. No new residential development would occur in the Rezoning Area under the future No-Action scenario. Therefore, the socioeconomic conditions study area would have a No-Action population of 22,534 persons in 2029 and a With-Action population of 23,415/23,625 or an increase of 4.84%.

Section 322.1 of Chapter 5 of the *CEQR Technical Manual* indicates that if the Proposed Action is expected to result in a study area population increase of less than 5%, further analysis is not warranted to assess the potential for indirect residential displacement and the proposed increase in population is not expected to affect real estate market

¹ US Census, ACS Demographic and Housing Estimates 2011-2015 (2017)

conditions. Additionally, it should be noted that approximately 181 of the 380 new residential units are assumed to be permanently affordable to incomes below 80% AMI and would not be expected to affect real estate conditions. Therefore, the Proposed Actions would not result in potential impacts related to socioeconomic character and further assessment is not required.



6. COMMUNITY FACILITIES AND SERVICES

Introduction

The community facilities and services considered under CEQR are public schools, public or publicly subsidized day care centers, public libraries, hospitals and other health care facilities, and police and fire protection services. Under the guidelines set forth in the *CEQR Technical Manual*, a detailed analysis is required only if a proposed action would displace or otherwise directly affect an existing community facility or if it would place significant new demands on facilities or services. Most of the demand for community facility services is generated by the introduction of new residents in an area.

Direct Effects

The Proposed Actions would not physically displace or affect any existing community facilities, and would therefore have no direct impact on any community facilities or services. Therefore, further assessment of direct impacts is not warranted.

Indirect Effects

The *CEQR Technical Manual* provides a set of thresholds to use in determining whether detailed studies of potentially significant adverse indirect impacts related to community facilities and services are warranted. The With-Action RWCDs includes the development of 228 dwelling units on the Applicant's property (Projected Development Site 1) plus 156 dwelling units of housing on Projected Development Sites 2 through 6 for a total of 384 dwelling units in the Rezoning Area. Four existing units would be displaced for a net increase of 380 dwelling units. No new residential development is anticipated to occur under the No-Action RWCDs. Therefore, the Proposed Actions would result in the development of a net increase of 380 dwelling units in the Rezoning Area.

As approved by HPD, 227 of the 228 units on the Applicant Owned property (Projected Development Site 1) would be considered affordable with 65% or 148 units at 80% of Area Median Income (AMI) or less and 35% or 79 units at 100% AMI or less as approved by HPD. One dwelling unit would be provided for the building superintendent and is not included in the affordability breakdown. For the non-Applicant Owned Sites 2 through 6, the Mandatory Inclusionary Housing (MIH) provisions would apply. The required zoning text amendment to make the area applicable to MIH would require at least 20% of the proposed residential floor area on the non-Applicant owned Projected Development Sites to be reserved for incomes averaging 80% AMI, resulting in the development of 33 affordable units. All affordable units would be permanently affordable. In summary, there would be a total of 181 dwelling units on the Applicant Owned property and the non-Applicant owned Projected Development Sites reserved for household incomes averaging 80% AMI or less.

Based on *CEQR Technical Manual* criteria (Table 6-1), the development of 380 dwelling units would exceed the minimum number of 90 dwelling units for conducting a detailed analysis of impacts to public elementary and middle schools in the Borough of the Bronx. An assessment of the project's potential impacts on public elementary and middle schools is described below.

Under the criteria in Table 6-1, the development of 181 dwelling units at or below 80% of AMI would exceed the minimum number of 141 dwelling units for conducting a detailed analysis of impacts to publicly funded child care. As 181 dwelling units would be eligible for publicly funded child care, an assessment of the project's potential impacts on public child care facilities is described below.

Public Schools

The *CEQR Technical Manual* states that, in general, if a project would introduce more than 50 school-age children (elementary and intermediate grades), significant impacts on public schools may occur and further analysis of schools may be appropriate. The RWCDS under the Proposed Actions includes the development of 384 dwelling units, including 228 units on the Applicant controlled Projected Development Site 1 and 156 units on the non-Applicant Owned Sites 2 through 6. Four existing units would be displaced for a net increase of 380 dwelling units.

Based on the factors contained in Table 6-1a, the 380 net new dwelling units resulting from the Proposed Actions would be anticipated to generate a total of 209 public school students, including 148 elementary school and 61 middle school pupils. The 380 net new dwelling units would be anticipated to generate a total of 72 public high school students, which would fall below the threshold of concern of 150 high school level pupils. A detailed public elementary and intermediate schools analysis is provided below.

Publicly Funded Child Care Centers

Analyses of impacts to day care facilities are generally conducted for projects that produce substantial numbers of subsidized, low- to moderate-income family housing units which may generate a significant number of children who would be eligible for subsidized child care at publicly financed day care centers. The threshold number requiring further analysis would be the generation of 20 eligible children. Based on the Bronx multipliers in Table 6-1b of the *CEQR Technical Manual*, 140 dwelling units at or below 80% of AMI would be expected to generate 20 children under the age of 6 who would be eligible for public child care. Based on the With-Action RWCDS and the day care assumptions discussed above, the six Projected Development Sites would be developed with 181 units which would be reserved for low- and moderate-income tenants who would be at or below 80% of AMI. This would require the preparation of a child care analysis which is provided below.

Other Community Facilities

The development of 380 net new dwelling units of housing on the Projected Development Sites within the Rezoning Area would not be anticipated to exceed the thresholds of concern for any other community facilities and services. Based on the *CEQR Technical Manual*, the Proposed Actions would have no adverse impacts to libraries, health care facilities, or fire and police protection.

Public Schools

Existing Conditions

Primary Study Area (Sub-district Analysis)

The Project Site is located in Bronx Community School District (CSD) 11, Sub-district 1 which is considered to be the primary study area for the analysis of elementary and intermediate schools.

Within CSD 11, Sub-district 1, there are 15 elementary schools and 10 intermediate level schools. Figure 6-1, Public Elementary and Intermediate Schools Within CSD 11, Sub-district 1, illustrates the locations of these public elementary and intermediate schools.

Table 6-1 provides a listing of the elementary and intermediate schools within CSD 11, Sub-district 1. The table identifies the schools by school number/name, address, and grades served, and includes the latest available enrollment and school capacity numbers.

Elementary school capacity numbers are less than actual building capacities as they assume a class size reduction for Kindergarten through the third grades of 20 children per class, 28 children for grades 4-8; and 30 children for grades 9-12 (“target capacity”).

Table 6-1 indicates that the elementary schools within CSD 11, Sub-district 1 are generally over capacity with the exception of three of the 15 schools and have an average utilization rate of approximately 115% with enrollments ranging from 86% to 173% of target capacity at individual school buildings. The elementary schools within CSD 11, Sub-district 1 have a total enrollment of 11,490 students relative to a target capacity of 9,962 seats resulting in a shortfall of 1,528 seats.

Table 6-1 indicates that 8 of the 10 intermediate level schools in CSD 11, Sub-district 1 are over capacity and have an average utilization rate of 98% with rates ranging from 66% to 149% of target capacity at individual middle school buildings. The intermediate level schools in CSD 11, Sub-district 1 have a total enrollment of 4,818 students relative to a target capacity of 4,915 seats resulting in 97 available seats.

Table 6-1							
CSD 11, Sub-district 1 (Primary Study Area) - Existing Enrollment, Capacity and Utilization 2016-2017 School Year							
#	School Number (Bldg ID)	Address	Grades	School Enrollment	Target Capacity	Available Seats	% Utilized
ELEMENTARY SCHOOLS							
1	P.S. 41	3352 Olinville Ave.	PK-5	935	682	-253	137
2a	P.S. 76	900 Adee Ave.	PK-5	729	682	-47	107
2b	P.S. 76 Temp. Bldg.	900 Adee Ave.	PK-5	250	158	-92	158
3a	P.S./I.S. 83	950 Rhinelander Ave.	PK-8	563	516	-47	109
3b	P.S./I.S. 83 Annex	950 Rhinelander Ave.	PK-8	504	413	-91	122
4a	P.S./I.S. 89	980 Mace Ave.	PK-8	839	814	-25	103
4b	P.S./I.S. 89 Temp. Bldg.	980 Mace Ave.	PK-8	162	112	-50	145
5a	P.S. 96	2385 Olinville Ave.	PK-5	955	947	-8	101
6a	P.S. 97*	1375 Mace Ave.	PK-5	577	364	-213	158
6b	P.S. 97 Temp. Bldg.	1375 Mace Ave.	PK-5	167	156	-11	107
7a	P.S. 105	725 Brady Ave.	PK-5	850	993	143	86
7b	P.S. 105 Temp. Bldg.	725 Brady Ave.	PK-5	367	269	-98	136
8a	P.S. 106	1514 Olmstead Ave.	PK-5	1,109	979	-130	113
9	P.S. 108*	1166 Neill Ave.	PK-5	596	345	-251	173
10a	P.S. 121	2750 Throop Ave.	PK-5	842	775	-67	109
10b	P.S. 121 Temp. Bldg.	2750 Throop Ave.	PK-5	103	105	2	98
11	P.S./I.S. 194	2365 Waterbury Ave.	PK-8	866	637	-229	136
12	P.S. 357	800 Lydig Ave.	PK-5	274	220	-54	125
13	P.S./I.S. 498	1640 Bronxdale Ave.	PK-8	354	239	-115	148
14	P.S. 567	1560 Purdy St.	PK-5	347	318	-29	108
25	P.S. 481	1684 White Plains Rd.	PK-5	101	238	137	42
	Subtotal			11,490	9,962	-1,528	115
INTERMEDIATE SCHOOLS							
15a	P.S./I.S. 83	950 Rhinelander Ave.	PK-8	361	331	-30	109
15a	P.S./I.S. 83	950 Rhinelander Ave.	PK-8	322	265	-57	122

	Annex						
16a	P.S./I.S. 89	980 Mace Ave.	PK-8	427	414	-13	103
16b	P.S./I.S. 89 Temp. Bldg.	980 Mace Ave.	PK-8	82	57	-25	144
17	I.S. 127	1560 Purdy St.	6-8	776	783	7	99
18	I.S. 144	2545 Gunther Ave.	6-8	497	757	260	66
19	P.S./I.S. 194	2365 Waterbury Ave.	PK-8	479	353	-126	136
20	I.S. 326	2441 Wallace Ave.	6-8	394	375	-19	105
21	I.S. 468	2441 Wallace Ave.	6-8	333	229	-104	145
22	P.S./I.S. 498	1640 Bronxdale Ave.	PK-8	284	191	-93	149
23	I.S. 556	2441 Wallace Ave.	6-8	394	580	186	68
24	I.S. 566	2545 Gunther Ave.	6-8	469	580	111	81
	Subtotal			4,818	4,915	97	98
	TOTAL			16,308	14,877	-1,431	110
* Utilization calculated based on enrollment including students in TCUs. Capacity of TCUs excluded.							
Source: 2016-2017 Enrollment, Capacity and Utilization Report, NYC Department of Education. Target Capacity assumes maximum classroom capacity of 20 children per class for grades K-3; 28 children for grades 4-8; and 30 children for grades 9-12.							

There is one elementary and one elementary/middle school level charter school within CSD 11, Sub-district 1 which are not included in the table above. Per *CEQR Technical Manual* guidelines, charter school enrollments are not included in NYC Department of Education (DOE) enrollment projections. The elementary and middle school level charter school in the sub-district includes the following:

1. Carl Icahn Charter School 2, 1640 Bronxdale Avenue, PK-8, 323 elementary and middle school students enrolled, 251 elementary seats and 116 middle school seats target capacity, 44 available seats.
2. Bronx Charter School for Better Learning, 2545 Gunther Avenue, PK-5, 148 elementary school students enrolled, 112 elementary seats target capacity, shortfall of 36 seats.

Future No-Action Scenario

This section presents an analysis of public school enrollments (including Pre-Kindergarten enrollments) and capacities for the project build year of 2029 without the Proposed Actions. The analysis includes the primary study area of CSD 11, Sub-district 1 and is derived from DOE enrollment projections.

In the future and absent the Actions, it is assumed that no new residential development would occur in the Rezoning Area by the project build year of 2029. However, based on

the NYC School Construction Authority's (SCA) "Projected New Housing Starts" (aka Housing Pipeline) projections, additional student enrollments would occur in CSD 11, Sub-district 1 under the No-Build condition by the project build year of 2029 as presented in Table 6-2 below.

As outlined in the *CEQR Technical Manual*, No-Action school capacity changes considered in a community facilities analysis include information on proposed and adopted "Significant Changes in School Utilization" and the DOE's Five Year Capital Plan.

Since the DOE is actively engaged in an ongoing process of repurposing underutilized school space, either for its own programs or for Charter Schools, a school building that is significantly underutilized in the existing condition may be programmed to include a new school organization in the near future. In this case, the available capacity may be radically altered within a few months of when the assessment is made. In DOE's Underutilized Space Memorandum dated July 17, 2018, I.S. 144 in CSD 11, Sub-district 1 has been identified as underutilized by 150 to 299 seats.

DOE has opened and co-located the Bronx Charter School for Better Learning II (84XTBD, "BBL II") in building X144, located at 2545 Gunther Avenue in CSD 11, beginning in the 2015-2016 school year. BBL II was co-located in building X144 with J.H.S. 144 Michelangelo (11X144, "J.H.S. 144") and Pelham Gardens Middle School (11X566, "Pelham Gardens"), which are both existing zoned district middle schools that serve students in sixth through eighth grades. BBL II is a new public charter school that serves students in kindergarten through fifth grade. A "co-location" means that two or more school organizations are located in the same building and may share common spaces like auditoriums, gymnasiums, and cafeterias.

Pursuant to recent amendments to the Education Law, which provide certain new and expanding charter schools with access to facilities, BBL II requested co-located space within a DOE facility. BBL II is a replication of the Bronx Charter School for Better Learning (84X718, "BBL"), an existing public charter school located in District 11 in the X111 building, located at 3740 Baychester Avenue, Bronx, NY 10466. BBL serves students in kindergarten through fifth grades, and the majority of these students reside in District 11. BBL performs well in comparison to schools within the Bronx and across New York City. In the 2013-2014 school year, BBL ranked in the 81st percentile for Citywide and 96th percentile for District-wide English Language Arts ("ELA") proficiency scores. In the 2013-2014 school year, BBL ranked in the 87th percentile for Citywide and 91st percentile for District-wide math proficiency scores. Given BBL's record of success and the need for additional elementary school seats in the Bronx resulting from kindergarten and elementary school enrollment growth, the DOE supported the placement of BBL II in District 11.

BBL II has been authorized by the State University of New York Trustees (SUNY) to serve students in kindergarten through fourth grade with the plan to grow through fifth grade following its first charter renewal. Beginning in the 2015-2016 school year, BBL II will serve approximately 70-80 kindergarten students, and it will add one grade each school year thereafter until it reaches its full grade span of kindergarten through fifth grades in 2020-2021. At that time, BBL II will serve 420-480 students in kindergarten through fifth grades.

According to the 2013-2014 Enrollment, Capacity, Utilization, Report (the “Blue Book”), building X144 has a target capacity of 1,534 students. During the 2014-2015 school year, the building serves a total of approximately 1,025 students, yielding a building utilization rate of approximately 67%. According to the Under-utilized Space Memorandum, building X144 is “under-utilized” and has space to accommodate additional students. BBL II, J.H.S. 144, and Pelham Gardens will collectively serve between 1,380 and 1,500 students in the X144 building in 2020-2021, which yields a projected utilization rate of approximately 90% - 98%.

The DOE’s FY 2015-2019 Proposed Five Year Capital Plan Amendment dated February 2018 identified a need for 1,920 school seats in the Van Nest/Pelham Parkway area of CSD 11 in which the Rezoning Area is located. 548 of these seats were funded as of February 2018 and 548 seats are completed or in process. Completion of construction of these 548 seats as an addition to P.S. 97 is anticipated in April 2021. Based on the above, the analysis includes an increase of 548 school seats in CSD 11, Sub-district 1 in the future 2029 analysis year.

Table 6-2 indicates that there would be a substantial shortfall of seats at the elementary school level within Sub-district 1 in 2029 without the proposed project. However, the middle school level would have a small excess capacity.

Table 6-2						
Estimated Public School Enrollment, Capacity, and Utilization Year 2029						
Future Without the Proposed Actions						
School Level	2029 Projected Enrollment (w/Pre-K)	Students Generated by Development Without Actions	Total Projected Enrollment	Program Capacity	Seats Available	Program Utilization (%)
Elementary/Pre K-5 Schools						
Sub-district 1	14,185	304	14,489	10,142 ²	-4,347	142.9%
Intermediate/Secondary 6-8 Schools						
Sub-district 1	4,800	77	4,877	4,915	38	99.2%
Source: DOE Enrollment Projections (Projected 2016-2025)						

Sub-district Projections

	<i>Percentages for Sub-district 1</i>	<i>Projected Enrollment</i>
P.S.	58.45% (x 24,268)	14,185
I.S.	53.5% (x 8,972)	4,800

Future With-Action Scenario

As stated above, applying the household multipliers for the Bronx from Table 6-1a of the *CEQR Technical Manual* to the maximum RWCDs of 380 net new dwelling units, would result in the anticipated generation of approximately 209 elementary and middle school children. Approximately 148 of these children would be elementary school students and the remaining 61 would be intermediate school enrollments. The development would not include the addition of any new schools or additional capacity in the District.

Table 6-3 presents the anticipated student enrollments that would be generated by the Proposed Actions and the effect of these enrollments on the available capacity of the schools within Sub-district 1. The projected increase of 148 elementary and 61 middle school students resulting from the Proposed Actions in 2029 would have a minimal impact upon the utilization rates of the schools in Sub-district 1. With the addition of these new enrollments, middle schools in Sub-district 1 would be slightly over capacity while elementary schools would remain substantially over capacity. However, based on *CEQR Technical Manual* criteria and as further explained below, it is not anticipated that the elementary school and middle school students that would be generated by the

² Includes 548 new seats as an addition to P.S. 97 anticipated by April 2021. Includes a decrease of 368 seats in capacity to accommodate the Bronx Charter School for Better Learning II which currently has a capacity of 112 seats and is projected to reach capacity of 480 students by 2021.

Proposed Actions would result in a significant impact on the elementary and intermediate schools in the area.

Table 6-3								
Estimated Public School Enrollment, Capacity, and Utilization Year 2029								
Future With the Proposed Actions								
School Level	2029 No-Build Projected Enrollment (w/Pre-K)	Students Generated by Develop (With Action)	Total Projected Enroll	Program Capacity	Seats Avail	Program Utiliz (%)	No Action Prog Utiliz (%)	Diff betw No Action/ With Action
Elementary/K-5 Schools								
Sub-dist 1	14,489	148	14,637	10,142	-4,495	144.3%	142.9%	1.4%
Intermediate/Secondary 6-8 Schools								
Sub-dist 1	4,877	61	4,938	4,915	-23	100.5%	99.2%	1.3%

According to the *CEQR Technical Manual*, a significant impact on schools may occur if the following two conditions are met. A significant impact may occur if the project results in a collective utilization rate of the elementary and/or intermediate schools in the Sub-district study area that is equal to or greater than 100 percent in the With-Action Condition, and if the project results in an increase of five percent or more in the collective utilization rate between the No-Action and With-Action conditions. With the Proposed Actions, the intermediate schools in Sub-district 1 would be slightly above 100 percent utilization (100.5%) while the elementary schools would be substantially more than 100 percent utilized (144.3%). The difference between the No-Action and With-Action utilization rate within Sub-district 1 of the middle schools would be 1.3 percent while that of the elementary schools would be 1.4 percent. Therefore, the Proposed Actions would not be expected to result in a significant adverse impact on elementary or intermediate schools. No further analysis of the Proposed Actions on public schools is therefore required.

Publicly Funded Child Care Centers

Existing Conditions

The *CEQR Technical Manual* states that the study area for publicly funded group child care and Head Start centers is approximately 1.5 miles around a project site. Since there are no locational requirements for enrollment in day care centers, some parents/guardians choose a day care center close to their employment rather than their residence. Nevertheless, the centers closest to the Rezoning Area are more likely to be subject to increased demand. A listing of child care centers within 1.5 miles of the

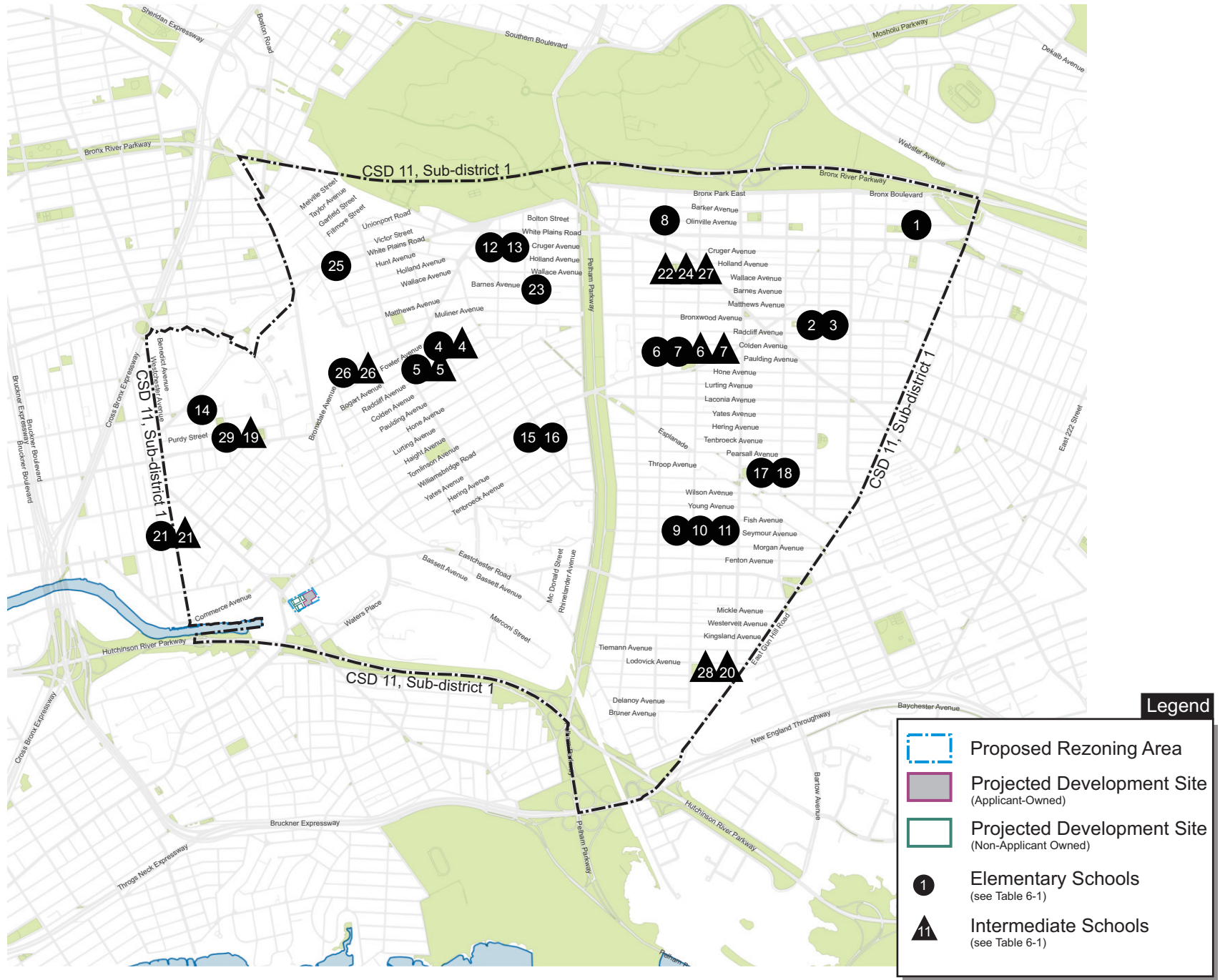

Rezoning Area is provided in Table 6-4 below. Figure 6-2, Publicly Funded Day Care Facilities Within 1.5 miles, illustrates the locations of these day care facilities. Information regarding existing day care facilities within the study area has been obtained from DCP based on Agency for Children’s Services (ACS) data.

A summary of this analysis indicates that the 1.5-mile radius around the Rezoning Area is well serviced by existing day care facilities. There are 3 day care facilities within this radius area with an overall capacity of 280 slots. In June 2018, 251 of these slots were in use, resulting in an overall utilization rate of approximately 89.6% of the day care facility slots in the project study area.

Future No-Action Scenario

Since enrollment projections for child care facilities are not available, CEQR analysis assumes that the existing enrollment and capacity would stay the same for the build year and be the baseline for the No-Action Scenario, unless affordable housing is identified. However, the *CEQR Technical Manual* recommends that ACS be contacted to obtain information on any changes planned for child care programs or facilities in the area of the proposed project, including closing or expansion of existing facilities and establishment of new facilities that would affect capacity in the build year. In discussions with DCP it was determined that it would not be necessary to contact ACS at this time as ACS is in the middle of a contracting cycle and is unlikely to make any changes to child care programs or facilities at the present or in the near future.

Therefore, in the future and absent the actions, it is assumed that no new affordable residential development would occur either in the Rezoning Area or within the surrounding 400-foot radius project study area by the project build year of 2029. In addition, per DCP guidance, at this time no changes to the capacities of day care facilities in the project study area are anticipated by 2029.

Table 6-4

**Existing Publicly Funded Group Child Care Facilities Within 1.5-Miles of Rezoning Area
Capacity, Enrollment, and Utilization
June 2018**

Site ID	Facility Name	Facility Address	Total Capacity	Total Enroll	% Enrollment
1	Westchester Tremont Day Care Center, Inc.	2547 East Tremont Avenue	86	75	87%
2	Lutheran Social Services of NY	2125 Watson Avenue	107	106	99%
3	Birch Family Services, Inc.	1880 Watson Avenue	87	70	80%
TOTAL			280	251	89.6%

Based on the above, the 1.5-mile radius around the Rezoning Area would remain well serviced by day care facilities in the future without the actions. As under the existing condition, 3 day care facilities would serve this radius area with an overall capacity of 280 slots. Approximately 251 of these slots would remain in use, resulting in an overall utilization rate of 89.6% of the day care facility slots in the project study area.

Future With-Action Scenario

The household multipliers for Brooklyn from Table 6-1b of the *CEQR Technical Manual* have been applied to the 181 eligible dwelling units on the six Projected Development Sites. The 181 eligible dwelling units within the Rezoning Area would generate 25 children who would qualify for public child care. These 25 additional children when added to the 251 existing/ no-action enrollments would result in a total enrollment with the proposed development of 276 children. Comparing this number to the capacity of 280 slots results in a utilization rate of 98.6%. This utilization rate is approximately 9.0% greater than the existing/ no-action condition.

According to the *CEQR Technical Manual*, a significant impact on publicly financed child care services may occur if the following two conditions are met. A significant impact may occur if the project results in a collective utilization rate of the group child care/Head Start centers in the study area that is greater than 100 percent in the With-Action Scenario, and if the project results in an increase of 5% or more in the collective utilization rate of the child care/Head Start centers in the study area between the No-Action and With-Action Scenarios.

The Proposed Actions would result in an increase of 9.0% in the collective utilization rate of the child care/Head Start centers in the study area, but the collective utilization rate of the group child care/Head Start centers in the study area would not exceed 100 percent. Therefore, the project study area would not have a shortage of day care slots. Based on *CEQR Technical Manual* criteria, the Proposed Actions would not be expected to result in a significant adverse impact on publicly financed child care services and mitigation would not be required.

Conclusion

The proposed project would not physically displace or alter a community facility or cause a change that could affect the service delivery of a community facility. In addition, the development would not create a demand that would either overtax, or not be met by existing or proposed services or facilities. Development under the Proposed Actions would not adversely affect public schools, publicly financed child care services, hospitals and other health care facilities, public libraries, and police and fire protection services. Therefore, the project would have no potentially significant adverse impacts related to community facilities and services and further assessment is not warranted.



7. OPEN SPACE

Introduction

For the purpose of CEQR, open space is defined as publicly or privately owned land that is publicly accessible and has been designated for leisure, play, or sport; or land that is set aside for the protection and/or enhancement of the natural environment. Under CEQR, an open space analysis is conducted to determine whether or not a proposed action would have either a direct impact resulting from the elimination or alteration of open space or an indirect impact resulting from overtaking the use of open space. The analyses focus only on officially designated existing or planned public open space. Open space may be public or private and may include active and/or passive areas. Active open space is the part of a facility used for active play such as sports or exercise and may include playground equipment, playing fields and courts, swimming pools, skating rinks, golf courses, lawns and paved areas for active recreation. Passive open space is used for sitting, strolling, and relaxation with benches, walkways, and picnicking areas. Certain spaces such as lawns, can be used for both active and passive recreation.

Open space analyses may be necessary when an action would potentially have a direct or indirect effect on open space. A direct impact would physically change, diminish or eliminate an open space or reduce its utilization or aesthetic value. An indirect impact could result from an action introducing a substantial new user population that would create or exacerbate an overutilization of open space resources.

Direct Effects

There are two open space facilities located within 400 feet of the Rezoning Area. These include Owen F. Dolen Park to the southwest and the Pelham Bay Little League to the southeast. Owen F. Dolen Park is a 1.4-acre facility bounded by Lane Avenue, East Tremont Avenue, and Westchester Avenue. The Pelham Bay Little League is a 1.26-acre park located along Westchester Avenue between Tan Place and Waters Avenue. Pelham Bay Little League is under a maintenance agreement and is not open to the public. The league essentially has exclusive use of this space. This resource is not open to the general public and is used by permit/league use. Due to the closeness of these parks to the Rezoning Area, potential shadows impacts could result from new development within the Rezoning Area. However, as discussed in the Shadows section below, no shadows from projected development within the Rezoning Area would affect these open space resources.

Indirect Effects

Introduction

On the basis of *CEQR Technical Manual* criteria, the projected developments in the Rezoning Area could potentially result in indirect effects to open space resources within the project study area and must be further assessed to determine whether significant indirect effects would be expected to occur. For projects that are not located in “underserved” or “well-served” areas identified in the *CEQR Technical Manual*, an open space assessment is conducted if that project would generate more than 200 residents or 500 workers.

The With-Action RWCDs includes the development of 384 dwelling units of housing on Projected Development Sites 1 through 6 in the Rezoning Area. Four existing units would be displaced for a net increase of 380 dwelling units. No new residential development is anticipated to occur under the No-Action RWCDs. Therefore, the Proposed Actions would result in the development of a net increase of 380 dwelling units in the Rezoning Area. Based on 2010 Census data, the average household size is 2.87 persons per dwelling unit in the Census Tracts located within 1/4-mile of the Rezoning Area (tracts 96, 194, 200, 202, 264, and 284). Therefore, the development of 380 dwelling units would be expected to generate approximately 1,091 residents in the Rezoning Area. The Proposed Actions would result in a development that would exceed the threshold number of 200 new residents and a preliminary quantitative analysis of indirect open space impacts is therefore required.

The Proposed Actions would generate approximately 169 workers in the Rezoning Area based on an estimate of 3 workers per 1,000 gsf of retail space (48,729 gsf), 4 workers per 1,000 gsf of medical office space (2,024 gsf), and 0.04 workers per dwelling unit for the 384 dwelling units noted above. (It should be noted that this is a very conservative analysis as it does not take into account the existing 39,704 gsf of commercial space and the 4 existing residences that would be removed by projected development within the Rezoning Area). New employees would therefore not exceed the threshold number of 500 new workers, and a quantitative analysis of indirect open space impacts for employees would not be required.

Preliminary Assessment

Based on the methodologies presented in the *CEQR Technical Manual*, an initial quantitative open space assessment involves a determination of an area’s open space ratio based on the population of the study area and the acreage of all publicly accessible open space resources within this study area. If an area’s open space ratio decreases significantly as a result of a proposed action or if an area has a very low open space ratio, a more detailed assessment may be required.

Based on the calculation of the ratio of publicly accessible open space acres to the study area population, a determination of the adequacy of open space resources in the study area was quantified. The resultant computation for the study area was then compared with the median ratio for New York City, which is 1.5 acres per 1,000 residents, and with the City's benchmarks of 2.5 acres per 1,000 population as identified in the *CEQR Technical Manual*.

The *CEQR Technical Manual* considers an action to result in significant impacts to open space resources if it would decrease the open space ratio substantially, thereby reducing the availability of open spaces for an area's population. A decrease in the open space ratio of 5 percent or more is generally considered to be a significant adverse impact on open space resources. However, if the existing open space ratio is low even an open space ratio change of less than 1 percent may result in potential significant open space impacts.

The project study area exhibits a below average open space ratio of 1.217 acres per 1,000 residents, (based on 23.8 acres of existing open space divided by the 2010 Census study area population of 19,551 persons).

Existing Conditions

Study Area Population

The study area population was estimated using data from the 2010 U. S. Census of Population and Housing for the accessible census tracts located fully or at least 50 percent within the one-half mile study area. As shown in Table 7-1, in 2010 the study area contained a total of 19,551 residents within the seven relevant census tracts.

Table 7-1

Study Area Population

Census Tract	Total Population (2010)
96	2,594
200	4,334
202	2,155
204	2,976
256	1,663
264	4,935
284	894
Study Area Total	19,551

Study Area Open Space

The one-half mile open space study area is generally bounded by Basset Avenue on the north, Newbold Avenue on the south, Plymouth Avenue on the east, and Home Avenue on the west. Within the census tracts that are fully or at least 50 percent within this area, there are three publicly owned and accessible facilities (See Figure 7-1, Open Space Facilities and Census Tracts and Table 7-2, Inventory of Open Space Resources), providing a total of approximately 23.8 acres of open space resources including 0.668 acres of active open space and 23.132 acres of passive open space. There are also three Little League Parks which are under maintenance agreements and are not open to the public. The leagues who have these parks are essentially given exclusive use of the space. These resources are not open to the general public and are used by permit/league use. The acreage of these resources has not been included in the total acreage within the study area.

**Table 7-2
Inventory of Open Space Resources
Blondell Commons**

Map Key	Open Space Name & Location	Owner	Total Size (acres)	Size within Study Area (acres) ³	Active Open Space (acres)	Passive Open Space (acres)	Features	Condition	Utilization
1	Samuel H. Young Park Westchester Ave. betw. Waters Ave. & E. Tremont Ave.	DPR	1.28	[1.28]	N/A	N/A	N/A	N/A	N/A
2	Pelham Bay Little League Park Westchester Ave. betw. Tan Pl. & Waters Ave.	DPR	1.26	[1.26]	N/A	N/A	N/A	N/A	N/A
3	Hutchinson River Parkway Greenway Whitestone Bridge Approach to the NYC- Westchester County Line	DPR	229.14	21.74	0	21.74	walkways, landscaping	good	low

³ Note that Pelham Bay Little League, Samuel Young, and Castle Hill Little League Parks are under maintenance agreements and are not open to the public. The leagues who have them are essentially given exclusive use of the space. These resources are not open to the general public and are used by permit/league use. The acreage of these resources has not been included in the total acreage within the study area.

4	Owen F. Dolen Park Between Lane Ave., E. Tremont Ave., & Westchester Ave.	DPR	1.40	1.40	0.14	1.26	recreation center, seating, paths, landscapings	acceptable (DPR-4/2/18)	moderate	
5	The Pearly Gates St. Peter's Ave. at Tratman Ave.	DPR	0.66	0.66	0.528	0.132	playground, handball & basketball courts, spray shower, seating, pathways	acceptable (DPR-7/13/18)	moderate	
6	Castle Hill Little League Field Zerega Ave. betw. Commerce Ave & Gleason Ave.	DPR	1.71	[1.71]	N/A	N/A	N/A	N/A	N/A	
Tot			235.45	23.8	0.668	23.132				

Assessment of Open Space Adequacy

The open space ratio was calculated based on the study area population of 19,551 persons shown in Table 7-1 and the total open space acreage of 23.8 acres including 0.668 acres of active open space and 23.132 acres of passive open space shown in Table 7-2. The resultant ratio is 1.217 acres of open space per 1,000 residents comprised of 0.034 acres of active open space and 1.183 acres of passive open space. This ratio falls below the citywide average of 1.5 acres as well as the benchmark of 2.5 acres per 1,000 population, indicating that the area has a below average amount of public open space resources. The area's residential active open space ratio is below DCP's planning guideline of 2.0 acres per 1,000 residents. The study area's residential passive open space ratio exceeds DCP's goal of 0.5 acres per 1,000 residents.

Future No-Action Condition

Study Area Population

As stated above, the 2010 census population of the half-mile open space study area was 19,551 persons. In order to account for background growth to the 2029 project build year, a conservative annual growth rate of 0.5% per year was applied to the 2010 population of the ½-mile open space study area. This growth factor would result in the addition of 1,857 additional residents. Therefore, as projected to 2029, the base population is projected to be 21,408 residents. No new residential development would occur in the Rezoning Area under the future No-Action scenario. Therefore, the open space study area would have a No-Action population of 21,408 persons in 2029.

Study Area Open Space

There would be no increase or decrease in the 23.8 acres of existing open space area including 0.668 acres of active open space and 23.132 acres of passive open space within the project study area by the project build year of 2029.

Assessment of Open Space Adequacy

The future no-action open space ratio within a ½ mile radius of the Rezoning Area would be approximately 1.112 based on the area population of 21,408 persons in 2029 and the 23.8 acres of open space area. Based on 0.668 acres of active open space, the future no-action active open space ratio would be 0.031. Based on 23.132 acres of passive open space, the future no-action passive open space ratio would be 1.081.

Future With-Action Scenario

Study Area Population

As discussed above, the Proposed Actions are expected to generate approximately 1,091 new residents based on existing census data (average household size) in the Census Tracts located within 1/4-mile of the Rezoning Area (tracts 96, 194, 200, 202, 264, and 284). Adding this population to the future no-action population of 21,408 would result in a total study area population of approximately 22,499 persons.

The Proposed Actions would generate approximately 169 new workers in the Rezoning Area. (It should be noted that this is a very conservative analysis as it does not take into account the existing 39,704 gsf of commercial space and the 4 existing residences that would be removed by projected development within the Rezoning Area). New employees would therefore not exceed the threshold number of 500 new workers and a quantitative analysis of indirect open space impacts for employees would not be required. The addition of 169 new workers to the Rezoning Area relative to existing and Future No-Action conditions would not affect the conclusions of this analysis in a substantive manner.

Study Area Open Space

No new publicly accessible open space and recreational resources are planned to be added to the study area by 2029 with the Proposed Actions. Therefore, in 2029 with the Proposed Actions, the project study area would contain approximately 23.8 acres of open space resources including 0.668 acres of active open space and 23.132 acres of passive open space, the same as under currently existing and future no-action conditions.

Assessment of Open Space Adequacy

Based on a population of 22,499 persons and 23.8 acres of open space resources including 0.668 acres of active open space and 23.132 acres of passive open space, the

projected open space ratio in 2029 with the Proposed Actions would be 1.058 acres per 1,000 residents including 0.030 acres of active open space and 1.028 acres of passive open space. This is compared to 1.112 acres of open space including 0.031 acres of active open space and 1.081 acres of passive open space in the future no-action condition. This represents a decrease of approximately 0.054 acres or 4.9 percent in the open space ratio. Therefore, the community would continue to have a below average amount of open space compared to the City as a whole and relative to DCP’s open space planning goal.

Table 7-3 shows the calculation of open space ratios for the existing, Future No-Action, and Future With-Action Scenarios.

Table 7-3

Existing, Future No-Action, and Future With-Action Open Space Ratios

	Existing Conditions	Future No-Action	Future With-Action
Publicly Accessible Open Space (Acreage)	23.8 (0.668 active, 23.132 passive)	23.8 (0.668 active, 23.132 passive)	23.8 (0.668 active, 23.132 passive)
Study Area Population	19,551	21,408	22,499
Open Space Ratio (Acres/1,000 Residents)	1.217 (0.034 active, 1.183 passive)	1.112 (0.031 active, 1.081 passive)	1.058 – 0.054 ac/4.9% decrease (0.030 active, 1.028 passive)

Impact Significance

Quantitative Impact

The *CEQR Technical Manual* considers an action to result in significant impacts to open space resources if it would directly displace or alter an existing resource to the detriment of its users. The project development associated with the proposed rezoning would not result in the direct displacement of any parklands or recreational facilities. The Proposed Actions would, however, reduce the open space ratio as further discussed below.

At 1.058 acres per 1,000 population, the amount of publicly accessible open space with the Proposed Actions would remain below the average of 1.5 acres per 1,000 population in community districts in the City. The amount of publicly accessible open space would also remain below the benchmark of 2.5 acres per 1,000 population.

The *CEQR Technical Manual* considers an action to result in significant impacts to open space resources if it would directly displace or alter an existing resource to the detriment of its users or generate a substantial enough population to noticeably diminish the capacity of available open spaces to serve the affected neighborhood. A decrease in the open space ratio of 5 percent or more is generally considered to be a significant adverse impact on open space resources only if the area has an average open space ratio of 1.5 acres or less per 1,000 population.

Relative to indirect impacts on open space resources, the proposed development would result in a decrease of 4.9 percent in the open space ratio in the project study area, which would be below the 5 percent threshold of concern noted in the *CEQR Technical Manual*. Although at an open space ratio of 1.058 the ratio in the project study area would be below the community district median of 1.5 acres per 1,000 population, it would not be considered to be an extremely low ratio. Therefore, based on *CEQR Technical Manual* criteria, the proposed project would not result in a significant adverse impact on open space resources.

A detailed open space assessment is not required as it has been determined that the project would not decrease the open space ratio by more than 5 percent in an area with a community district median of 1.5 acres or less per 1,000 population. In addition, private open space would be provided on Projected Development Sites 1, which would serve to meet at least a portion of the active and passive open space needs of the project's residents. The development would contain indoor recreational facilities totaling 5,773 sf in area which would include an approximately 1,090 sf children's playroom, an approximately 1,454 sf fitness room, and an approximately 3,229 sf multi-purpose room on the first floor of the building. An approximately 10,011 sf passive outdoor recreational area and a second approximately 2,686 sf passive outdoor recreational area would be provided at the rear of the building.

Qualitative Impact

The *CEQR Technical Manual* considers an action to result in significant impacts to open space resources if it would significantly increase shadows, noise, air pollutant emissions, or odors on existing public open spaces resources compared to the future without the action conditions. The project development associated with the proposed rezoning would not increase such impacts on existing public open spaces resources as further explained below.

Based on *CEQR Technical Manual* criteria and as explained further in the Shadows section below, buildings on Projected Development Sites 1 through 6 would not cast new shadows on any open space resources as the open space areas located within the maximum shadow radius of these buildings are located too far away to be affected by shadows from these developments.

It should also be noted that there are additional open space resources directly adjacent to the ½-mile project study area including approximately 207.4 acres of primarily passive open space that is part of the Hutchinson River Parkway Greenway extending between the Whitestone Bridge Approach and the NYC-Westchester County Line. Bufano Park, a 1.9-acre playground and primarily active recreational resource, is located adjacent to the ½-mile project study area boundary along Bradford Avenue between La Salle and Waterbury Avenues. Approximately 90% or 1.71 acres of this facility consists of active recreational facilities including handball and basketball courts, a playground, a roller hockey rink, and spray showers.

Conclusion

Due to the absence of direct impacts on any open space resource and the negligible decrease in the future with the action open space ratio relative to the amount of available open space, it is concluded that the project would not have any potentially significant adverse open space impacts and further assessment is not warranted.

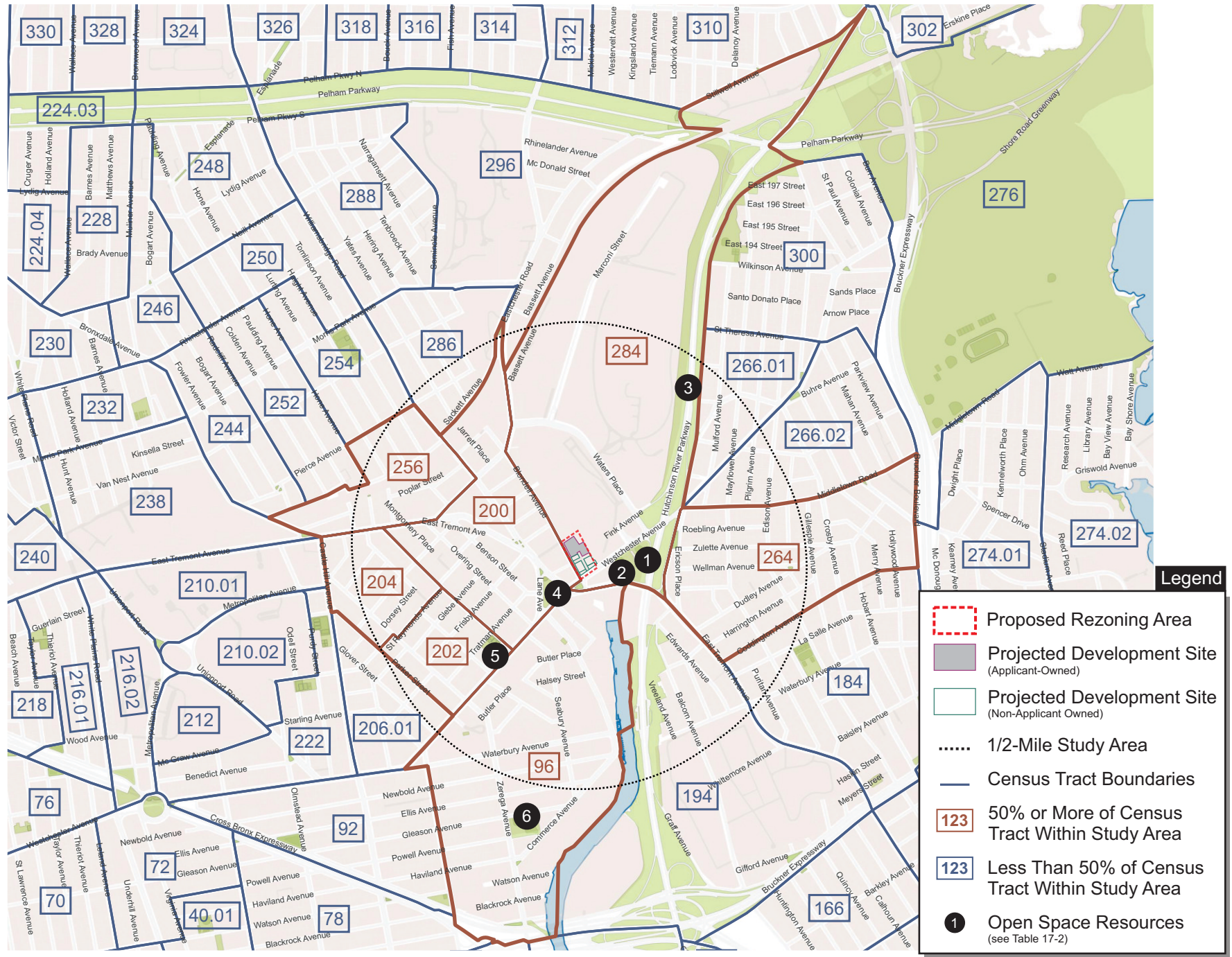

8. SHADOWS

Introduction

Under CEQR, a shadow is defined as the circumstance in which a building or other built structure blocks the sun from the land. An adverse shadow impact is considered to occur when the shadow from a proposed project falls upon a publicly accessible open space, a historic landscape, or other historic resource if the features that make the resource significant depend on sunlight, or if the shadow falls on an important natural feature and adversely affects its uses or threatens the survival of important vegetation. An adverse impact would occur only if the shadow would fall on a location that would otherwise be in sunlight; the assessment therefore distinguishes between existing shadows and new shadows resulting from a proposed project. Finally, the determination of whether the impact of new shadows on an open space or a natural or historic resource would be significant is dependent on their extent and duration. In general, shadows on City streets and sidewalks or on other buildings are not considered significant under CEQR. In addition, shadows occurring within an hour and a half of sunrise or sunset generally are not considered significant under CEQR.

The heights of the buildings to the roofs of the top floors⁴ and the roofs of the bulkheads on the Projected Development Sites would be as follows:

- Projected Development Site 1: top floor roof: 98'-0"; elevator bulkhead: 115'-0"
- Projected Development Sites 2 through 6: top floor roof: 98'-0"; bulkhead roof: 110'-0"

According to the *CEQR Technical Manual*, a shadows assessment is not required unless the project would include a structure or an addition to a structure at least 50 feet in height or if it would contain shorter structures that might cast substantial new shadows on an adjacent park, historic resource, or an important natural resource. A shadows analysis is required for this project since some of the Projected Development Sites are located across the street from an open space resource and because the Proposed Actions would result in the development of six new structures that would exceed 50 feet in height.

Preliminary Screening Assessment

Tier 1 Screening Assessment

There are two shadow sensitive open space resources in the vicinity of the Projected Development Sites as shown on the attached Tier 1 Screening Assessment diagram.

⁴ Heights include a 3' parapet wall.

There are no historic resources in the vicinity of the Projected Development Sites. The shadow sensitive open space resources include the following:

- Owen F. Dolen Park located between Lane Avenue, East Tremont Avenue, and Westchester Avenue southwest of the Rezoning Area. This park is labeled "1" on the attached Tier 1 Screening Assessment diagram.

- Pelham Bay Little League Park located along Westchester Avenue between Tan Place and Waters Avenue and the adjacent Samuel H. Young Park located along Westchester Avenue between Waters Avenue and East Tremont Avenue southeast of the Rezoning Area. Pelham Bay Little League Park and Samuel H. Young Park are under maintenance agreements and are not open to the public. The leagues essentially have exclusive use of these spaces. These resources are not open to the general public and are used by permit/league use. These parks are labeled "2" on the attached Tier 1 Screening Assessment diagram.

The longest shadows radius is calculated as 4.3 times the maximum proposed building height including rooftop bulkheads. The longest shadow cast by the buildings on the six Projected Development Sites are as follows:

- Projected Development Site 1: elevator bulkhead roof: $115'-0'' \times 4.3 = 494.5'$

- Projected Development Sites 2 through 6: elevator bulkhead roof: $110'-0'' \times 4.3 = 473.0'$

The longest shadow of 494.5 feet on the Tier 1 shadow assessment figure was calculated as 4.3 times the maximum proposed building height of 115.0 feet including elevator bulkheads on the roof of the proposed 9-story building on Projected Development Site 1. However, Projected Development Site 6 is located in closest proximity to open space resources and the maximum shadow of 473.0 feet that would be cast by this 110.0-foot tall building would be of greater relevance to the shadows analysis.

Due to the proximity of the Projected Development Sites to the open space resources noted above, potential shadow impacts could occur from the projected development.

Tier 2 Screening Assessment

Based on the Tier 1 assessment, which showed the potential for the longest shadow to reach a sunlight sensitive open space resource, a Tier 2 assessment was generated. A Tier 2 assessment locates the area south of a building that cannot be cast in shadow. This area in New York City lies between -108 and +108 degrees from true north.

The attached Tier 2 Screening Assessment diagram shows the area south of the Projected Development Sites that cannot be shaded by the proposed project. As illustrated on the figure, approximately 70% of Owen F. Dolen Park is located within the area that cannot be shaded by the project. The remainder of Owen F. Dolen Park

and Pelham Bay Little League Park/Samuel H. Young Park could experience new shadows from the project and further assessment is therefore required.

Tier 3 Screening Assessment

The Tier 3 screening assessment is used to determine if shadows resulting from the proposed project can reach a sunlight-sensitive resource. The screening assessment uses three-dimensional computer modeling software with the capacity to accurately calculate shadow patterns.







A Tier 3 screening assessment was performed for the four representative days of the year set forth in the *CEQR Technical Manual*: December 21, the winter solstice and shortest day of the year; March 21/September 21, the equinoxes; May 6, the midpoint between the summer solstice and the equinox (and equivalent to August 6); and June 21, the summer solstice and the longest day of the year. The *CEQR Technical Manual* defines the temporal limits of a shadow analysis period to fall from an hour and a half after sunrise to an hour and a half before sunset. In accordance with the *CEQR Technical Manual*, surrounding buildings are not included in the Tier 3 shadow assessment model.

A Tier 3 screening assessment has been performed as the northern portion of Owen F. Dolen Park and the entirety of Pelham Bay Little League Park/Samuel H. Young Park lie within the area that could be shaded by the proposed project. However, as shown on the attached Tier 3 Screening Assessment diagrams, shadows from the projected developments would not reach either Owen F. Dolen Park or Pelham Bay Little League Park/Samuel H. Young Park on any day of the year.

Conclusion

Buildings on Projected Development Sites 1 through 6 would not cast any new shadows on shadow sensitive open space or historic resources. Therefore, the Proposed Actions would not result in any significant shadows impacts, and no further assessment is needed for the project.

Development Sites	1	2	3	4	5	6
Height above Lower Floor*	78'	73'	73'	73'	73'	73'
Height above Top Floor*	98'	98'	98'	98'	98'	98'
Maximum Bulkhead Height	115'	110'	110'	110'	110'	110'

-  Project Site
-  Proposed Building Footprint
-  Roof above 9th Floor (98')*
-  Roof above Bulkheads (105-115')
-  Longest Shadow Study Area Boundary
-  Potentially Affected Sunlight-Sensitive Open Space Resource
-  Development Sites

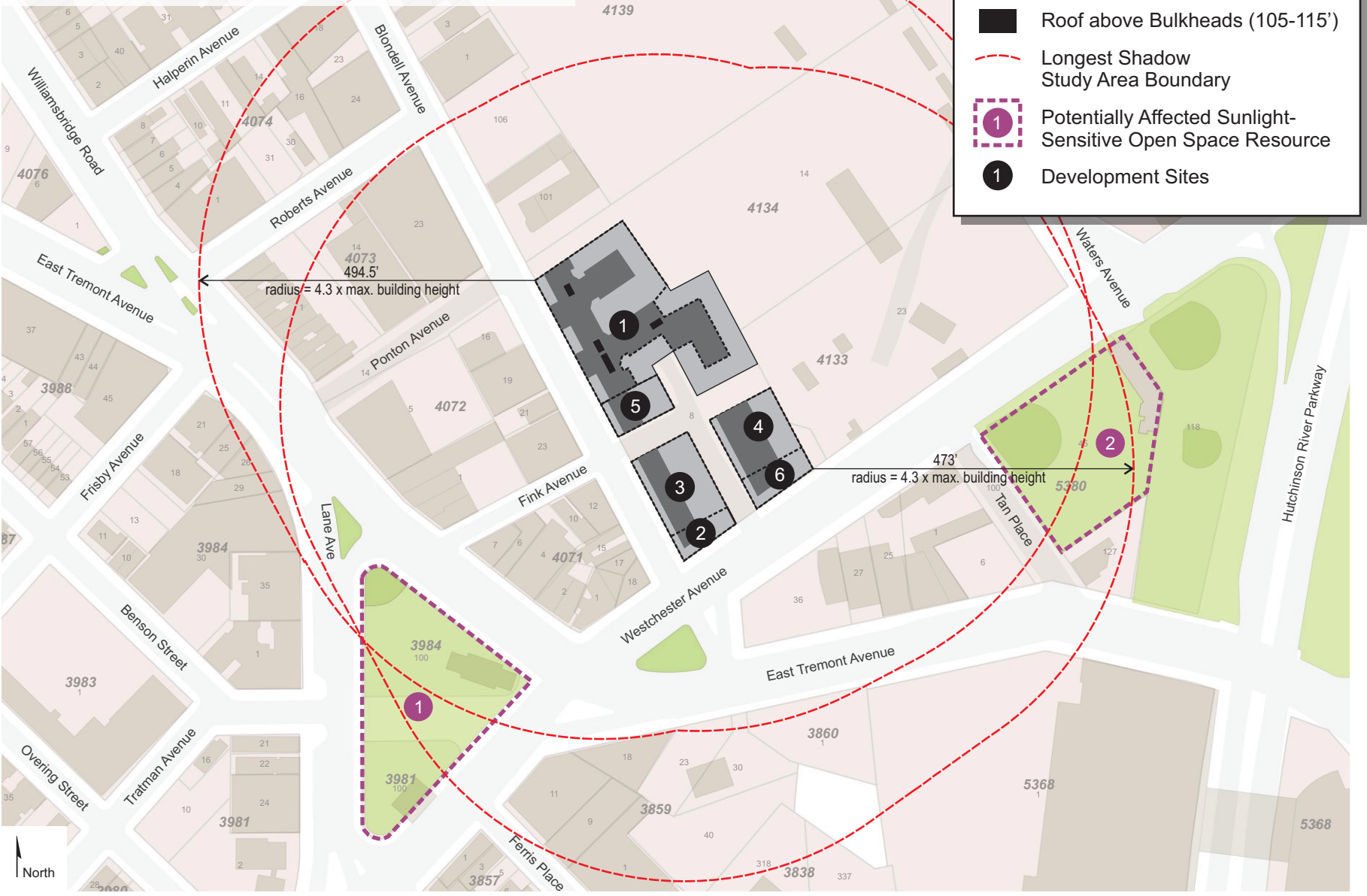

*Heights include a 3' parapet wall

Development Sites	1	2	3	4	5	6
Height above Lower Floor*	78'	73'	73'	73'	73'	73'
Height above Top Floor*	98'	98'	98'	98'	98'	98'
Maximum Bulkhead Height	115'	110'	110'	110'	110'	110'

-  Project Site
-  Proposed Building Footprint
-  Roof above 9th Floor (98')*
-  Roof above Bulkheads (105-115')
-  Longest Shadow Study Area Boundary
-  Potentially Affected Sunlight-Sensitive Open Space Resource
-  Development Sites
-  Area that Cannot Be Shaded by the Proposed Building









*Heights include a 3' parapet wall



Legend

Development Sites	1	2	3	4	5	6
Height above Lower Floor*	78'	73'	73'	73'	73'	73'
Height above Top Floor*	98'	98'	98'	98'	98'	98'
Maximum Bulkhead Height	115'	110'	110'	110'	110'	110'







-  Project Site
-  Proposed Building Footprint
-  Roof above 9th Floor (98')*
-  Roof above Bulkheads (105-115')
-  Shadow Cast / Analysis Time
-  Potentially Affected Sunlight-Sensitive Open Space Resource
-  Development Sites



*Heights include a 3' parapet wall

Legend

Development Sites	1	2	3	4	5	6
Height above Lower Floor*	78'	73'	73'	73'	73'	73'
Height above Top Floor*	98'	98'	98'	98'	98'	98'
Maximum Bulkhead Height	115'	110'	110'	110'	110'	110'

-  Project Site
-  Proposed Building Footprint
-  Roof above 9th Floor (98')*
-  Roof above Bulkheads (105-115')
-  Shadow Cast / Analysis Time
-  Potentially Affected Sunlight-Sensitive Open Space Resource
-  Development Sites



*Heights include a 3' parapet wall

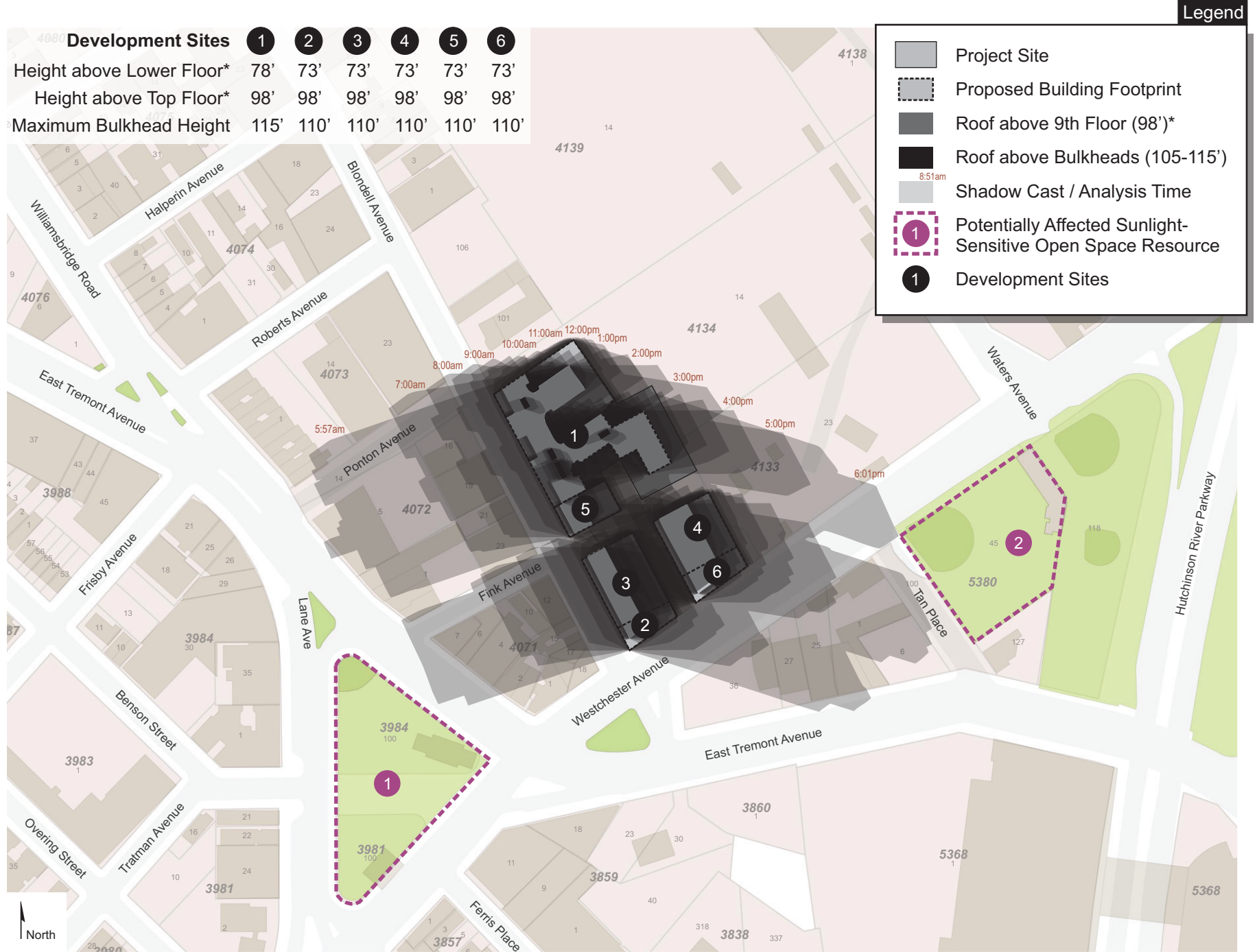

9. HISTORIC AND CULTURAL RESOURCES

The 2014 *City Environmental Quality Review (CEQR) Technical Manual* identifies historic resources as districts, buildings, structures, sites, and objects of historical, aesthetic, cultural, and archaeological importance. This includes designated New York City Landmarks (NYCL); properties calendared for consideration as landmarks by the New York City Landmarks Preservation Commission (LPC); properties listed in the State/National Registers of Historic Places (S/NR) or contained within a district listed in or formally determined eligible for S/NR listing; properties recommended by the New York State Board for listing on the S/NR; National Historic Landmarks (NHL); and properties not identified by one of the programs listed above, but that meet their eligibility requirements. An assessment of historic/archaeological resources is usually needed for projects that are located adjacent to historic or landmark structures or within historic districts, or projects that require in-ground disturbance, unless such disturbance occurs in an area that has already been excavated.

As discussed in the Project Description, the Applicant is seeking a Zoning Map Amendment from an existing M1-1 district to a R7A/C2-4 district of properties bounded by Blondell Avenue, Ponton Avenue, Westchester Avenue, and the NYC Transit Yard in the Westchester Square neighborhood of the Bronx, Community District 11. The Proposed Actions would involve a rezoning of the Applicant's property, Block 4134, Lot 1 (formerly Block 4134, Lots 1, 2, 4, 62, 63, and 70 and Block 4133, Lot 12), and non-Applicant properties, identified as Block 4133, Lots 1, 2, 8 (partial as the Fink Avenue portion of this lot is not zoned and is to be demapped in association with a change to the City Map), 10, 61, 62, and 63 (partial as a portion of this lot is located outside of the Rezoning Area boundary) plus 50% of the to be demapped portion of Ponton Avenue (Block 4134, Lot 14-partial) adjacent to the Rezoning Area. The Applicant is proposing a Zoning Text Amendment to modify ZR §23-933, Appendix F to designate the newly mapped R7A/C2-4 district as a Mandatory Inclusionary Housing (MIH) designated area. The Proposed Actions also include a demapping of Fink Avenue between Blondell and Waters Avenues.

With the proposed map and text amendments, the Applicant would develop on Block 4134, Lot 1 a new nine-story and cellar, 95'-0" tall mixed-use building totaling 261,660 gsf and containing 228 dwelling units within 198,683 gsf on floors 1-9 (plus 7,558 gsf of cellar space). 227 of the 228 units would be considered affordable with 65% or 148 units at 80% of AMI or less and 35% or 79 units at 100% AMI or less as approved by HPD. One dwelling unit would be provided for the building superintendent and is not included in the affordability breakdown. The development would also contain 19,668 gsf of retail space and 2,024 gsf of community facility space. The development would include 225 attended accessory parking spaces.

The Rezoning Area and the 400-foot radius project study area are not a Federal, State, or New York City designated Historic District and do not contain any individually designated historic resources. As such, a historic architectural analysis is not warranted for the Proposed Actions.

The New York City Landmarks Preservation Commission (LPC) has determined that the Applicant's Projected Development Site 1 does not have any historic or archaeological significance. LPC has also determined that there are no potential historic or archaeological resources on Projected Development Sites 2 through 6. (See 5/3/17 LPC letter in Historic and Archaeological Resources Appendix to this document.)

The Proposed Actions would not result in any significant adverse impacts to historic or archaeological resources.

10. URBAN DESIGN AND VISUAL RESOURCES

Introduction

An assessment of urban design is needed when a project may have effects on any of the elements that contribute to the pedestrian experience of public space. A preliminary assessment is appropriate when there is the potential for a pedestrian to observe, from the street level, a physical alteration beyond that allowed by existing zoning, including the following:

1. Projects that permit the modification of yard, height, and setback requirements;
2. Projects that result in an increase in built floor area beyond what would be allowed 'as-of-right' or in the future without the proposed project.

The Proposed Actions include:

A. A Zoning Map Change to Sectional Map # 4b - Rezoning of the Proposed Development Site, Block 4134, Lot 1, from its existing M1-1 zoning to the proposed R7A/C2-4 zoning. Rezoning of the Non-Applicant Owned Sites, identified as Block 4133, Lots 1, 2, 8 (partial), 10, 61, 62, and 63 (partial) and Block 4134, Lot 14 (partial), from their existing M1-1 zoning to the proposed R7A/C2-4 zoning.

B. A Zoning Text Amendment - Modify ZR §23-933, Appendix F to designate the newly mapped R7A/C2-4 district as a Mandatory Inclusionary Housing designated area.

C. A Change to the City Map - Eliminate, discontinue, and close Fink Avenue between Blondell Avenue and Waters Avenue (Block 4133, part of Lot 8), and adjust grades necessitated thereby, including authorization for any acquisition or disposition of real property related thereto (demap a mapped but unbuilt portion of Fink Avenue that traverses the Development Site).

The maximum amount of floor area that would be permitted in the Rezoning Area in the future under the existing zoning is up to 99,281 zoning square feet of manufacturing/commercial space or up to 238,274 square feet of community facility space. However, in the Future Without the Action it is not anticipated that any new development would occur in the Rezoning Area. No new as-of-right development would occur on the Projected Development Sites as the area's existing M1-1 zoning precludes the development of any residential uses. In addition, market conditions in the area are not supportive of the development of new or expanded manufacturing or 'free-standing' (without the development of residential uses) commercial uses. Although a maximum community facility FAR of 2.4 would be permitted on these lots, the proposed Rezoning Area and the surrounding project study area are primarily commercial and industrial in character and do not contain a residential population large enough to support community facility uses. Further explanation for why the

individual Sites in the Rezoning Area would not be developed in the No-Action condition is provided below.

At an FAR of 2.21 and 2.67, respectively, Projected Development Sites 3 and 5 are developed in excess of the permitted FAR of 1.0 in the M1-1 district while Projected Development Site 6 is developed to an FAR of 0.8 which is close to the maximum permitted FAR. Although the remaining Projected Development Sites 1, 2, and 4 are developed at well below the maximum permitted FAR of 1.0, most of the surface area of these Sites is used for vehicle parking and storage in connection with vehicle repair and towing businesses located on these properties. Therefore, no further development would be anticipated on any of these Sites.

It is assumed that Other Site 1 would also remain in its existing condition as detailed above. The Fink Avenue portion of the lot is a mapped but unbuilt street. No change would occur to this portion of the lot absent the proposed demapping in the With-Action scenario. The Cooper Avenue and Grant Street portions of the lot would continue to be used as a driveway access to the adjoining parcels.

It is assumed that Other Site 2, which consists of 50% of the to be demapped portion of Ponton Avenue, would be improved with parking. Based on the Ponton Avenue Demapping EAS (11DCP136X), the demapped portion of Ponton Avenue would be used for accessory parking and vehicle storage. Up to 12 accessory parking spaces would be provided. No new construction would take place on this portion of Ponton Avenue beyond paving, fencing, lighting, and additional security features.

The maximum amount of floor area that would be permitted in the Rezoning Area in the future under the proposed zoning calculated on the basis of maximum FAR is up to 456,692 zoning square feet of residential floor area, up to 198,562 square feet of commercial space, or up to 397,124 square feet of community facility space.

In the Future With the Action, the Rezoning Area is projected to be developed with six new buildings containing a total of 449,828 gsf of floor area including 384 dwelling units (based on an average size of 871 gsf per dwelling unit excluding cellar space) 260 of which would be affordable units, 48,729 gsf of commercial retail/office space, 2,024 gsf of community facility space (day care center and medical offices), and 265 accessory parking spaces. The developments on the Projected Development Sites would be 95 feet in height.

The projected development discussed in the paragraph above would result in the removal of the existing 39,704 gsf of office and retail space, 6,775 gsf of storage and automobile related floor area (automobile repair and storage), 4,410 gsf of residential floor area for 4 market rate dwelling units, one abandoned 766 gsf dwelling unit, and parking areas on the six Development Sites. The increment between the Future No-

Action and Future With-Action scenarios would result in an increase of 398,173 gsf of total floor area and would include the addition of 380 dwelling units 260 of which would be affordable units, 9,025 gsf of commercial retail/office space, 2,024 gsf of community facility space (day care center and medical offices), and 265 accessory parking spaces. Other Site 1 would be partially demapped. The Proposed Actions would also permit the modification of the existing yard, height, and setback requirements of the lots within the Rezoning Area and introduce new buildings with greater height. A preliminary urban design assessment is therefore required.

Preliminary Assessment

Existing Conditions

Rezoning Area

The Rezoning Area roughly comprises the western one-third of Blocks 4133 and 4134 in the Westchester Square neighborhood of the Bronx, between Blondell Avenue, Ponton Avenue, Westchester Avenue, and Waters Place. Blondell Avenue, which forms the western boundary of the Rezoning Area, is a one-way northbound street extending approximately seven blocks from Westchester Avenue to Eastchester Road. Ponton Avenue, which forms the northern boundary of the Rezoning Area, is proposed to be a demapped street within the Rezoning Area. Waters Place, which extends beyond the eastern edge of the Rezoning Area, is a two-way loop road connecting Westchester Avenue to Eastchester Road. Westchester Avenue, which forms the southern boundary of the Rezoning Area, is a major multi-lane, two-way thoroughfare connecting the Bruckner Expressway to the east with the Cross Bronx Expressway, Sheridan Expressway and 3rd Avenue to the west. The Rezoning Area consists of approximately 106,968 square feet of land area.

The Rezoning Area is developed with 39,704 gsf of office and retail space, 6,775 gsf of storage and automobile related floor area (automobile repair and storage), 4,410 gsf of residential floor area for 4 market rate dwelling units, one abandoned 766 gsf dwelling unit, parking areas, street rights-of-way, and vacant land. The existing development on each of the Projected Development Sites as well as Other Sites is detailed below.

Projected Development Sites

Projected Development Site 1 (Block 4134, Lot 1) consists of a 46,360 sf lot developed with 6,210 gsf of building floor area. Uses on the lot include vehicle parking and vehicle storage in connection with a towing facility, a one-story 4,500 gsf auto body repair facility, a two-story 944 gsf building used for offices, vehicle parking, and vehicle storage in connection with the towing facility, a one- to two-story 766 gsf residential structure containing 1 dwelling unit (currently abandoned), and vacant land used as a street (Cooper Avenue between Ponton and Fink Avenues).

Projected Development Site 2 (Block 4133, Lot 1) consists of a 2,874 sf lot developed with two 1-story buildings totaling 1,075 gsf in size and used for automobile repair and storage.

Projected Development Site 3 (Block 4133, Lot 2) consists of a 11,250 sf lot developed with a 1-story building totaling 24,900 gsf in size and used for office space, a garage, and related uses.

Projected Development Site 4 (Block 4133, Lot 63 (p/o)) consists of a 11,663 sf lot developed with a 1-story building totaling 1,200 gsf in size and used for storage.

Projected Development Site 5 (Block 4133, Lot 10) consists of a 4,950 sf lot developed with a 2-story building totaling 13,230 gsf in size and used for 4 dwelling units (4,410 gsf) and 8,820 gsf of retail space.

Projected Development Site 6 (Block 4133, Lots 61 & 62) consists of two lots that would be merged. The 1,642 sf Lot 61 is developed with a 2-story building totaling 3,040 gsf in size and used for office and retail space. The 2,500 sf Lot 62 is developed with a 1-story building totaling 2,000 gsf in size and used for retail space.

Other Sites

Other Site 1 (Block 4133, Lot 8) is an 18,022 sf cross shaped lot. The horizontal portion of the lot consists of Fink Avenue which extends east from Blondell Avenue and is a mapped but unbuilt street. A horizontal portion of Fink Avenue, aka Grant Street, is used as a driveway access to the adjoining parcels. The vertical portion of the lot consists of Cooper Avenue which extends north from Westchester Avenue and is used as a driveway access to the adjoining parcels.

Other Site 2 (Block 4134, p/o Lot 14) is a 7,687 sf strip of land forming the northern boundary of the Rezoning Area consisting of 50% of the to be demapped portion of Ponton Avenue extending east from Blondell Avenue.

The Rezoning Area does not contain any visual resources such as open space facilities, historic resources, or natural resources.

400-Foot Radius Project Study Area

The area surrounding the Rezoning Area is characterized by a wide variety of land uses including both single and multi-family residential, mixed use (residential-commercial), commercial, manufacturing, transportation/utilities, automotive/parking, and several parks and other community facilities. The New York City Transit's (NYCT) 6-Train elevated subway line runs to the south of the Rezoning Area and a large NYCT Train Yard occupies the eastern portion of the project study area.

There are retail uses fronting on East Tremont Avenue in close proximity to the Westchester Square elevated subway station and light manufacturing, warehouse, storage yard, and automotive uses are located along both sides of Blondell Avenue. Retail uses consisting of newsstands, eating and drinking establishments, variety and discount stores, and other convenience retail uses are located to the southwest and west of the Rezoning Area. Most of these are located in one-story buildings, or on the ground floor of two- and three-story buildings (with either residential or office use above). Said buildings are built to the street line, and do not offer off-street parking, reflecting the pedestrian-oriented nature of the neighborhood.

Residential uses are mostly concentrated in the area to the west and northwest of the Rezoning Area. These neighborhoods include both single- and multi-family residential buildings. Smaller density buildings are either detached, semi-detached, and attached homes of between 1-3 stories, and multi-family apartments buildings rise to 6-stories.

Manufacturing, transportation/utility, and automotive-related uses are mostly located in the underlying M1-1 district (to the north, south, east, and west of the Applicant Site), and in the smaller M3-1 district located to the south along Westchester Creek. Central among such uses is the NYCT Train Yard that is located adjacent to the east of the Applicant Site that measures approximately 750 feet by 2,000 feet, and consumes most of blocks 4133, 4134, 4137, 4138, 4139, 4140, 4141, 4142 and 4143. The remaining uses are light manufacturing, warehouse, and automotive uses, such as repair shops. These are generally located in one- and two- story detached buildings, and often have adjacent parking or storage yards.

Scattered throughout the surrounding area are a number of parks and other community facilities. Adjacent to the southwest of the proposed Rezoning Area, Owen F. Dolen Park is located in the triangular area bound by East Tremont Avenue, Westchester Avenue and Lane Avenue, adjacent to the Westchester Square elevated subway stop. One block to the east of the Rezoning Area, Samuel H. Young Park occupies the majority of Block 5380. One block southeast of the proposed Rezoning Area is the campus of Herbert H. Lehman High School (Block 5368, Lots 1 and 2), which spans the Hutchinson River Parkway. Aside from these notable examples, there are also a number of other smaller community facilities such as small houses of worship, libraries, schools, and a post office located in the surrounding area.

Open space visual resources within the 400-foot radius project study area include Owen F. Dolen Park and Samuel H. Young Park noted above. No other visual resources including historic resources or natural resources exist within the 400-foot radius project study area.

An aerial photograph of the project study area and 35 ground level photographs of the Rezoning Area and the immediate context are attached which show existing conditions on the Site and in the surrounding area. Zoning calculations of the existing conditions on the Site, including floor area calculations, lot coverage, and building heights, are shown in Table 10-1 below.

No-Action Scenario

Rezoning Area

As stated above, in the Future Without the Action it is not anticipated that any new development would occur in the Rezoning Area. No new as-of-right development would occur on the Projected Development Sites as the area's existing M1-1 zoning precludes the development of any residential uses. In addition, market conditions in the area are not supportive of the development of new or expanded manufacturing or 'free-standing' (without the development of residential uses) commercial uses. Although a maximum community facility FAR of 2.4 would be permitted on these lots, the proposed Rezoning Area and the surrounding project study area are primarily commercial and industrial in character and do not contain a residential population large enough to support community facility uses.

It is assumed that Other Site 1 would also remain in its existing condition as detailed above. It is assumed that Other Site 2, which consists of 50% of the to be demapped portion of Ponton Avenue, would be improved with parking as also discussed above. Up to 12 accessory parking spaces would be provided.

The future No-Action Development Scenario in the Rezoning Area would be the same as the existing condition discussed above. The existing 39,704 gsf of office and retail space, 6,775 gsf of storage and automobile related floor area (automobile repair and storage), 4,410 gsf of residential floor area for 5 market rate dwelling units, one abandoned 766 gsf dwelling unit, and parking areas on the six Development Sites would remain as they currently exist. Therefore, no changes would occur to the existing urban design and visual character of the Rezoning Area.

400-Foot Radius Project Study Area

No future development actions were identified within the 400-foot radius project study area based on a review of the NYC Department of City Planning's (DCP) Land Use & CEQR Application Tracking System (LUCATS) for Bronx Community District 11 for the past ten year period.

No development plans are known to exist for the existing parking lots or other uses within the project study area as identified above by the project build year of 2029.

Therefore, surrounding land uses within the immediate study area are expected to remain largely unchanged by the project build year of 2029. The 400-foot area surrounding the Rezoning Area is developed with a wide variety of land uses including both single and multi-family residential, mixed use (residential-commercial), commercial, manufacturing, transportation/utilities, automotive/parking, and several parks and other community facilities. The New York City Transit's (NYCT) 6-Train elevated subway line runs to the south of the Rezoning Area and a large NYCT Train Yard occupies the eastern portion of the project study area. Other than the parking and storage lots and garages which are heavily utilized, few usable undeveloped parcels remain within the project study area and it is therefore anticipated that no significant new development would occur within this area by 2029. The character of the surrounding project study area would therefore not be expected to change significantly in the absence of the project.

Two open space visual resources exist within a 400-foot radius of the Rezoning Area, including Owen F. Dolen Park and Samuel H. Young Park. However, as no significant new development is anticipated to occur within this area, the No-Action Scenario would not result in any significant impacts to these visual resources. Zoning calculations of future No-Action conditions on the Site, including floor area calculations, lot coverage, and building heights, are shown in Table 10-1 below.

Future With-Action Scenario

The future With-Action Development Scenario would result in a denser development on the property as compared to the Existing/No-Action Development Scenario. Under the With-Action Scenario for the project build year of 2029, the six Projected Development Sites would be developed with six new buildings containing a total of 449,828 gsf of floor area including 384 dwelling units (based on an average size of 871 gsf per dwelling unit excluding cellar space) 260 of which would be affordable units, 48,729 gsf of commercial retail/office space, 2,024 gsf of community facility space (day care center and medical offices), and 265 accessory parking spaces. The existing 39,704 gsf of office and retail space, 6,775 gsf of storage and automobile related floor area (automobile repair and storage), 4,410 gsf of residential floor area for 4 market rate dwelling units, one abandoned 766 gsf dwelling unit, and parking areas would be removed. Other Site 1 would be partially demapped. The projected development on each of the six Development Sites and the two Other Sites is detailed below.

The Applicant seeks to develop Projected Development Site 1 with a new nine-story and cellar, 95'-0" tall mixed-use building totaling 261,660 gsf (including cellar area) and containing 228 studio and one-, two-, and three-bedroom dwelling units within 198,683 gsf (excludes residential cellar area) on floors 1-9 based on an average size of 871 gsf per dwelling unit. All units would be affordable. The development would also include 19,668 gsf of retail space on the first/ground floor, 2,024 gsf of community facility space

on the first floor (day care center and medical offices), and 225 attended parking spaces in the cellar and on the first floor of the building.

Projected Development Site 2 would be developed with a 9-story, 95'-0" tall 13,616 gsf mixed-use building containing 11,686 gsf of residential floor area for 13 dwelling units, 3 of which would be affordable. The development would also include 1,930 gsf of ground floor commercial space. No parking would be provided.

Projected Development Site 3 would be developed with a 9-story, 95'-0" tall 64,552 gsf mixed-use building containing 42,745 gsf of residential floor area for 49 dwelling units, 10 of which would be affordable. The development would also include 10,557 gsf of ground floor commercial space and 11,250 gsf for cellar level parking. 19 cellar level parking spaces would be provided on the Site.

Projected Development Site 4 would be developed with a 9-story, 95'-0" tall 66,922 gsf mixed-use building containing 45,989 gsf of residential floor area for 53 dwelling units, 11 of which would be affordable. The development would also include 9,270 gsf of ground floor commercial space and 11,663 gsf for cellar level parking. 21 cellar level parking spaces would be provided on the Site.

Projected Development Site 5 would be developed with a 9-story, 95'-0" tall 23,453 gsf mixed-use building containing 19,385 gsf of residential floor area for 22 dwelling units, 5 of which would be affordable. The development would also include 4,068 gsf of ground floor commercial space. No parking would be provided.

Projected Development Site 6 would be developed with a 9-story, 95'-0" tall 19,625 gsf mixed-use building containing 16,389 gsf of residential floor area for 19 dwelling units, 4 of which would be affordable. The development would also include 3,236 gsf of ground floor commercial space. No parking would be provided.

The Fink Avenue portion of Other Site 1 would be demapped and would not be developed. The Grant Street and Cooper Avenue portions of this lot would continue to be used as a driveway access to the adjoining parcels.

As described in the Future No-Action section above, Other Site 2 would be improved with parking. Up to 12 accessory parking spaces would be provided. No new construction would take place on this portion of Ponton Avenue beyond paving, fencing, lighting, and additional security features.

The difference between the No-Action and With-Action Scenarios on the six Projected Development Sites would be the removal of all existing development and the development under the With-Action Scenario of six new buildings resulting in an increase of 398,173 gsf of total floor area and including the addition of 380 dwelling

units 260 of which would be affordable units, 9,025 gsf of commercial retail/office space, 2,024 gsf of community facility space (day care center and medical offices), and 265 accessory parking spaces. Other Site 1 would be partially demapped.

The With-Action development would change the low-density commercial use, automobile related, parking, and vacant land character of the Rezoning Area to a higher density mixed-use residential and commercial community with accessory parking. The With-Action development would increase the density of development on the six Projected Development Sites. In addition to a significantly greater amount of floor area, the building heights would be significantly greater under the With-Action Scenario with the development of new 9-story buildings. The existing buildings in the Rezoning Area on the Applicant and non-Applicant Owned Sites are one- to two-stories in height.

Zoning calculations of future With-Action conditions on the Site, including floor area calculations, lot coverage, and building heights, are shown in Table 10-1 below. A three-dimensional representation of the future With-Action condition streetscape is also attached.

**Table 10-1
Zoning Calculations Relevant to Urban Design Analysis - Projected Development Sites**

Item	Existing Conditions	No-Action Conditions	With-Action Conditions
Development Scenario	39,704 gsf office/retail, 6,775 gsf automobile repair/storage, 4 market rate dwelling units, one abandoned dwelling unit, parking areas, street right-of-way/driveway, vacant land.	39,704 gsf office/retail, 6,775 gsf automobile repair/storage, 4 market rate dwelling units, one abandoned dwelling unit, parking areas, street right-of-way/driveway, vacant land, 12 accessory parking spaces.	384 dwelling units including 260 affordable units, 48,729 gsf retail/office, 2,024 gsf community facility (day care center, medical offices), 277 accessory parking spaces, street right-of-way/driveway.
Building Floor Area (except parking)	51,655 gsf	51,655 gsf	449,828 sf
Building Heights	One-story, two-story	One-story, two-story	Six 9-story (95')

Conclusion

The Proposed Actions would result in the development of residential, commercial, and community facility uses and accessory parking on six Projected Development Sites located in an area characterized by a mixture of commercial and automotive related uses, parking, and vacant land.

The proposed R7A/C2-4 district was chosen for the Rezoning Area in order to develop residential uses on the Applicant's property which is not allowed under its current M1-1 zoning. It is also required to allow the proposed bulk of the new building to be increased from the current permitted FAR of 1.0 for manufacturing and commercial uses and 2.4 for community facility uses to 4.0 for all permitted residential and community facility uses (manufacturing uses would not be allowed), 2.0 for commercial uses, and 4.6 as a bonus for inclusionary housing. The increase in permitted bulk is appropriate given the City's policy of promoting increased development in close proximity to transit stops. The change is also appropriate given the lack of demand for manufacturing facilities in this area, which is very underdeveloped. The establishment of a Mandatory Inclusionary Housing area for this application was developed in consultation with DCP in order to facilitate the development of affordable housing at a higher FAR in the area to be rezoned.

The proposed R7A zoning district is a contextual zoning district that requires development to be in accordance with Quality Housing standards. The district typically produces high lot coverage seven- and eight-story apartment buildings, blending with existing buildings in many established neighborhoods. R7A/C2-4 zoning was chosen for the Rezoning Area as an R7-1 district is mapped on a block bounded by Westchester Avenue, Waters Place, Waters Avenue, and Fink Avenue just outside of the 400-foot radius project study area to the east. R6 zoning districts are also mapped within and just beyond 400 feet of the Rezoning Area to the south and west. C2-4 commercial overlays are mapped within and just beyond 400 feet of the Rezoning Area along Westchester Avenue to the southwest.

The Proposed Actions include a change to the City Map that involves the elimination, discontinuance and closing of Fink Avenue between Blondell Avenue and Waters Avenue (Block 4133, part of Lot 8), and the adjustment of grades necessitated thereby, including authorization for any acquisition or disposition of real property related thereto (demap a mapped but unbuilt portion of Fink Avenue that traverses the Development Site). The portion of this street located within the Rezoning Area will be used for the development of the proposed mixed-use building on the Applicant's property.

The requested elimination of this portion of Fink Avenue makes ample sense given current conditions for several reasons: (1) The portion of the street in question is mapped, but unbuilt; (2) Given the location of an MTA NYC Transit train yard located to the east of the Development Site, it is highly unlikely the City will ever exercise its ability to build this portion of the street; (3) An application was approved to demap a parallel portion of Ponton Avenue (one block north) to a similar extent, further indicating that this portion of the originally proposed street network will not be built out (ULURP Application No.: 110342MMX; CEQR No.: 11DCP136X); and (4) the area

that would theoretically benefit from the building of this portion of Fink Avenue is already accessible from the private streets known as Grant Street and Cooper Avenue, which predate the mapping of Fink Avenue.

The With-Action Development Scenario would not result in any significant impacts to the two open space visual resources (Owen F. Dolen Park and Samuel H. Young Park) located within the Rezoning Area. These open space areas are located some distance from the Projected Development Sites and are separated from them by intervening development and major streets. The Proposed Actions would not partially or totally block a view corridor or a natural or built visual resource that is rare in the area or considered a defining feature of the neighborhood. The Applicant believes that the development that would be facilitated by the rezoning would represent a visual improvement to the area and would result in new development on the underdeveloped Projected Development Sites that is believed to be more compatible with the development pattern in residential areas further to the west. A detailed urban design analysis would not be required.





1. View of the Site facing southeast from Blondell Avenue.



2. View of the Site facing east from Blondell Avenue.



3. View of the Site facing northeast from Blondell Avenue.





4. View of Ponton Avenue facing northeast toward Blondell Avenue (Site at right).



5. View of Ponton Avenue facing southwest from the Site.



6. View of Blondell Avenue facing southeast from Ponton Avenue (Site at left).

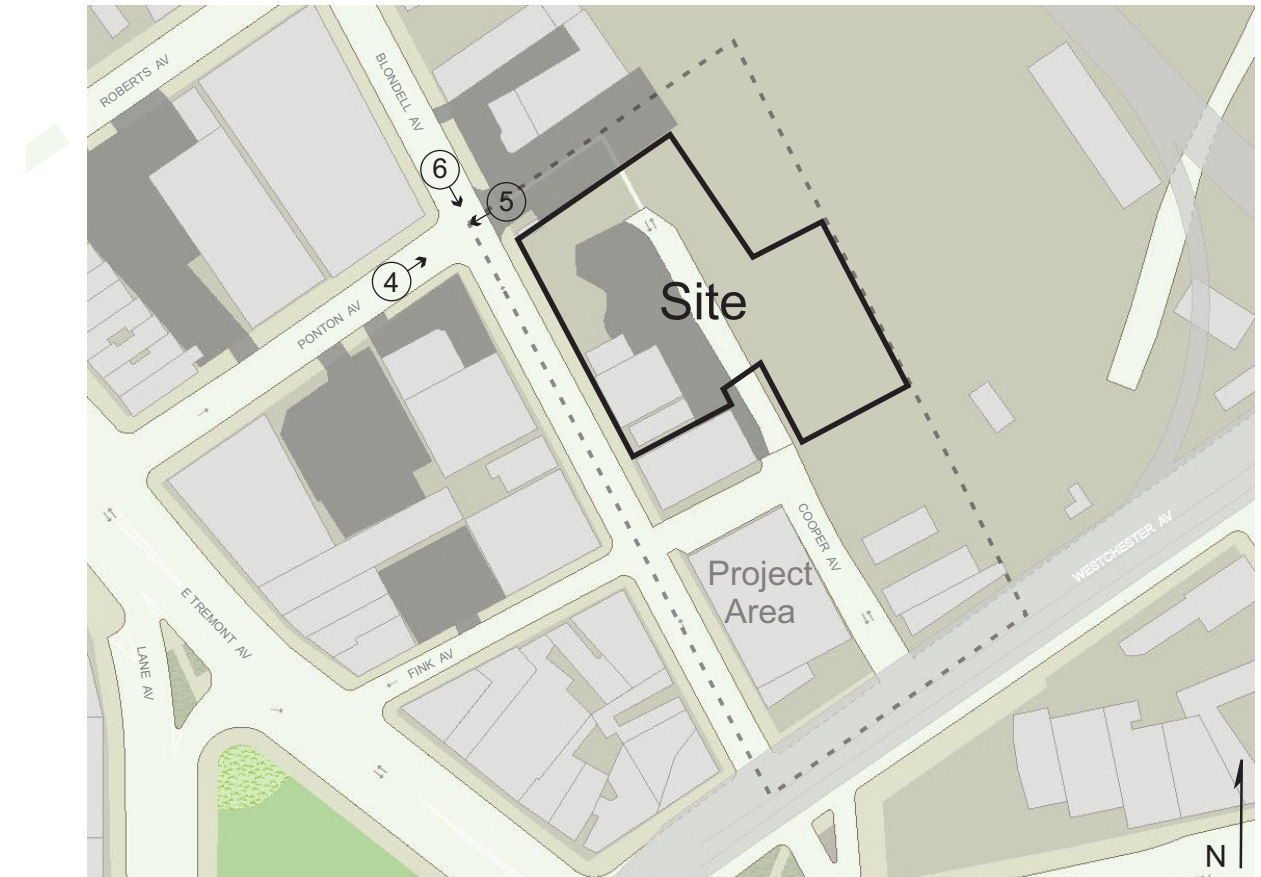



7. View of the sidewalk along the east side of Blondell Avenue facing southeast (Site at left).



8. View of the west side of Blondell Avenue facing northwest from the Site.



9. View of the west side of Blondell Avenue facing southwest from the Site.

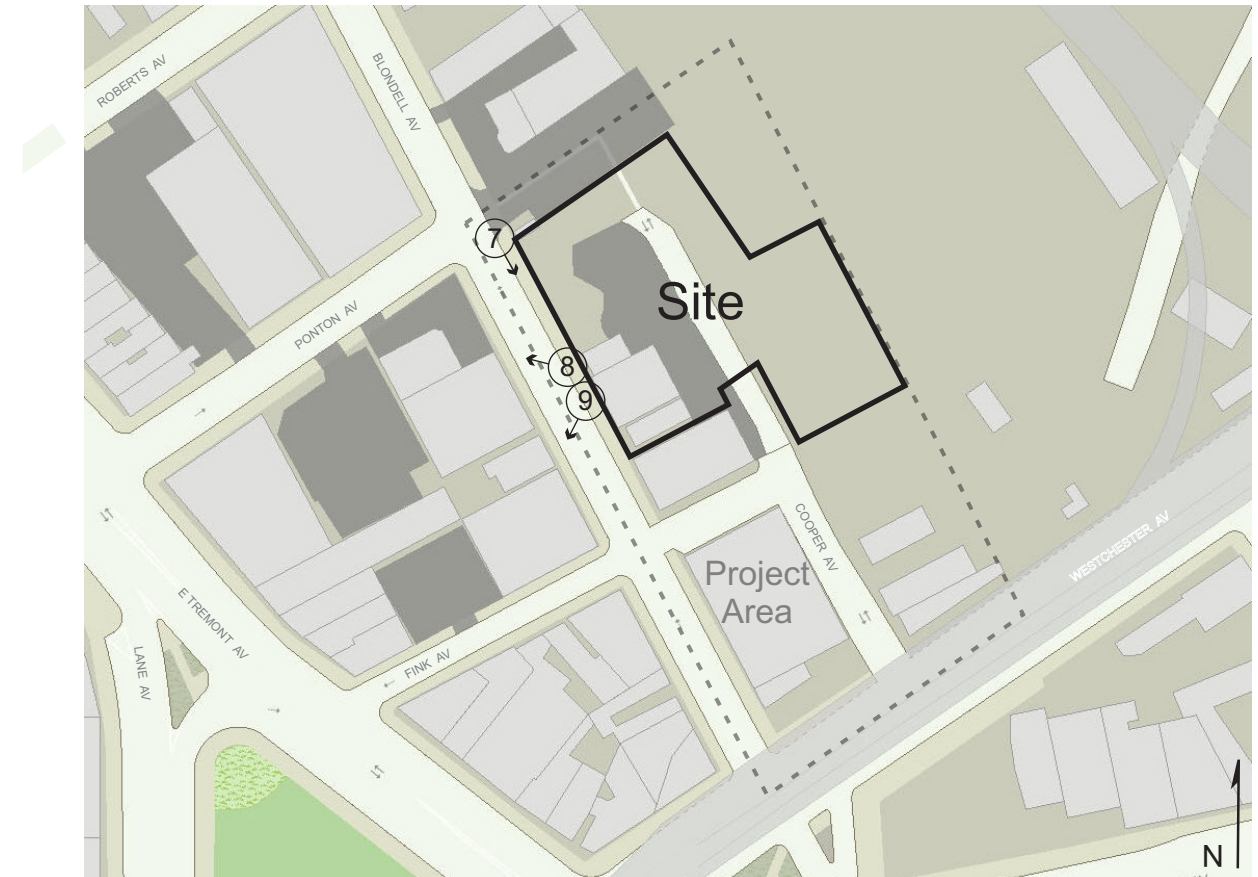



10. View of the east side of Blondell Avenue facing southeast toward Fink Avenue.



11. View of Fink Avenue facing northeast toward Blondell Avenue.



12. View of the sidewalk along the east side of Blondell Avenue facing northwest (Site ahead, at right)

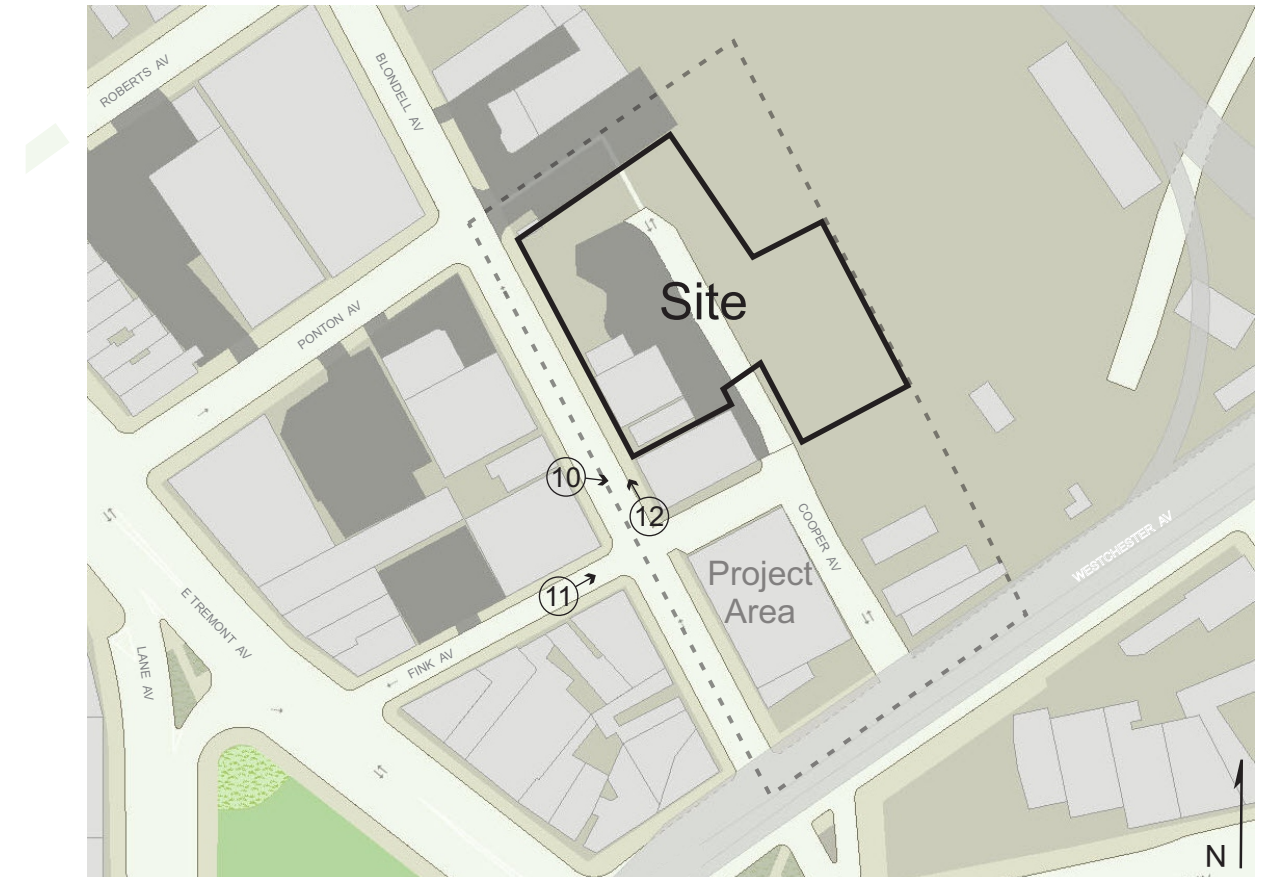



13. View of Fink Avenue facing southwest from Blondell Avenue.



14. View of Fink Avenue facing southwest from Cooper Avenue.



15. View of the north side of Fink Avenue facing northwest from Cooper Avenue.

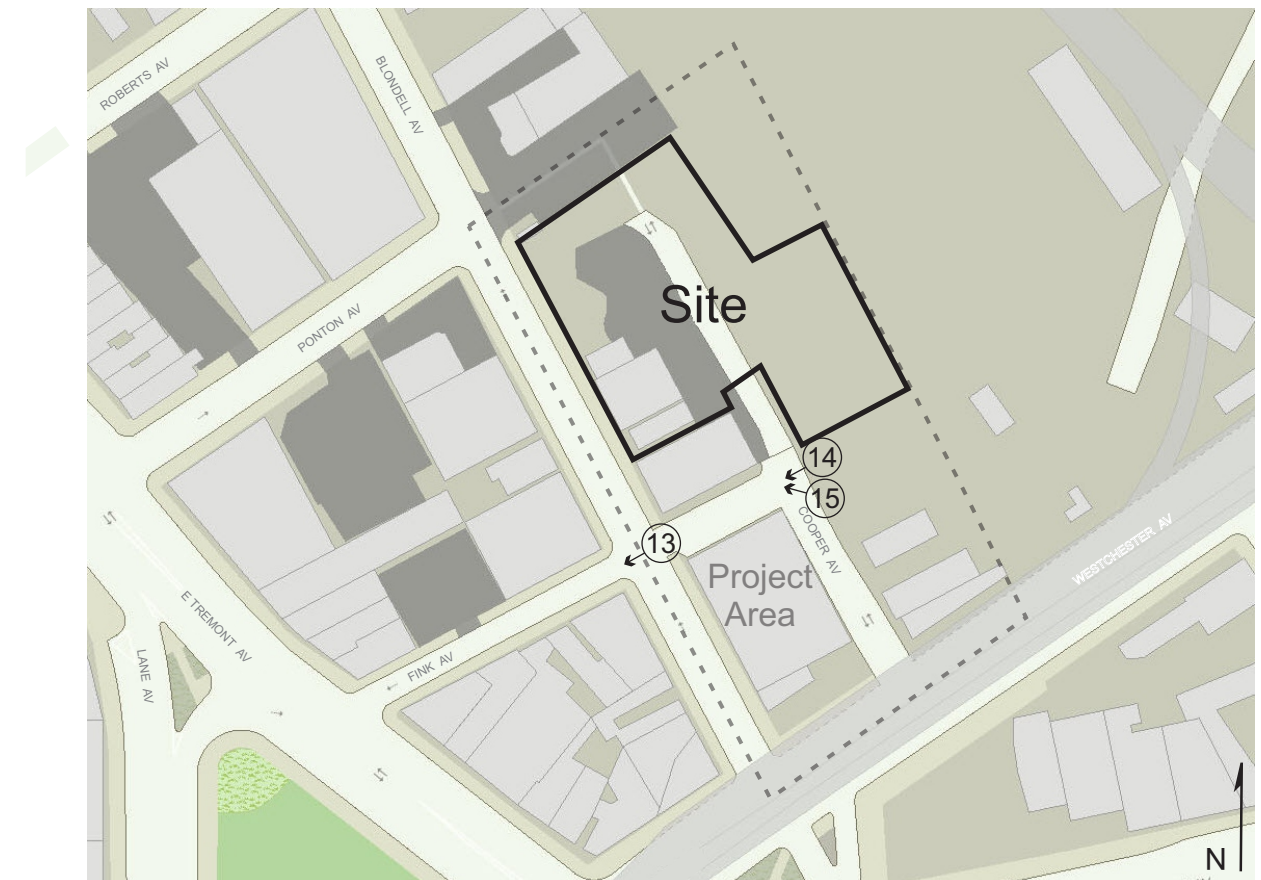



16. View of the south side of Fink Avenue facing southwest from Cooper Avenue.



17. View of Cooper Avenue facing southeast toward Fink Avenue from the Site.



18. View of the Site facing northwest from the intersection of Cooper Avenue and Fink Avenue.

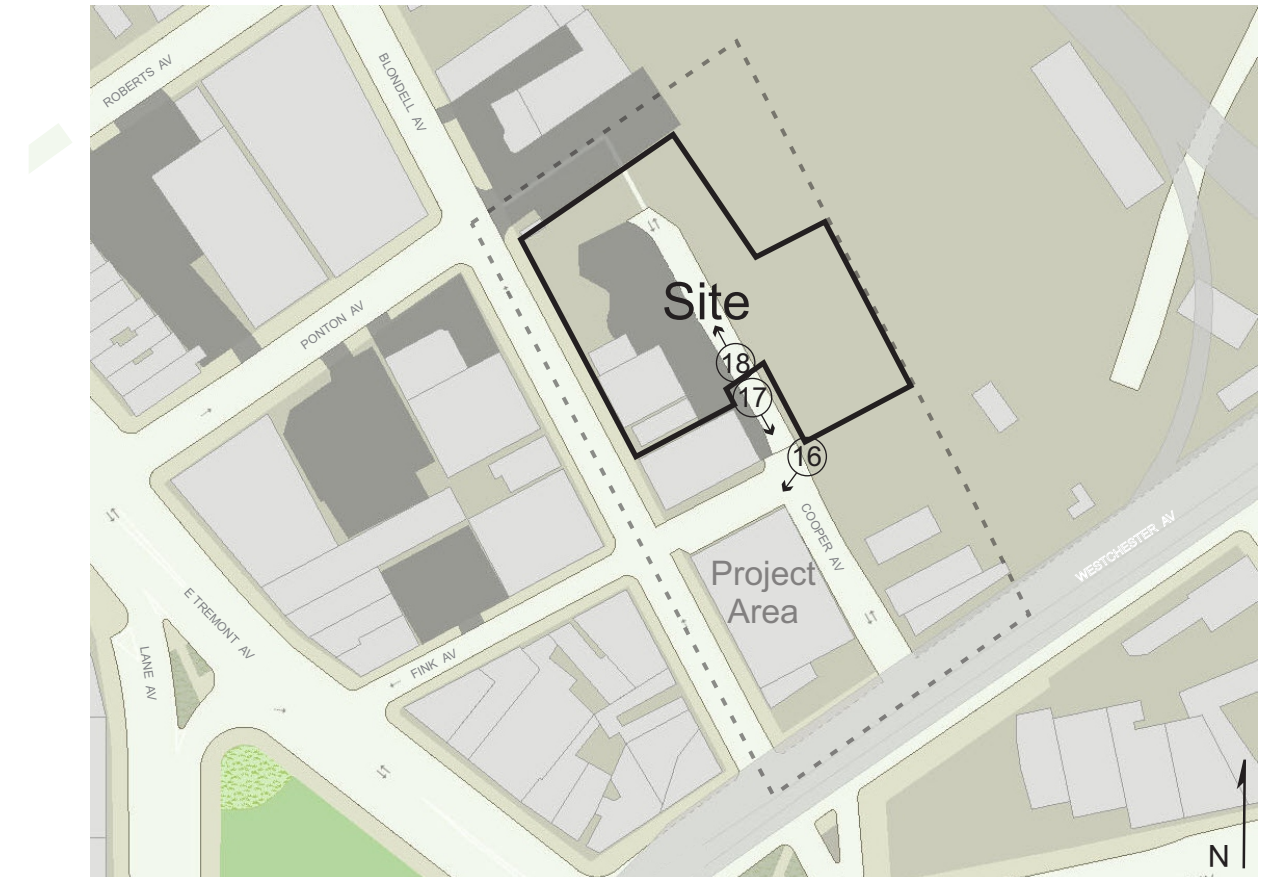



19. View of the east side of Cooper Avenue between Fink Avenue and Westchester Avenue facing northeast.



20. View of the east side of Cooper Avenue facing northeast from Westchester Avenue.



21. View of Cooper Avenue facing northwest from Westchester Avenue.





22. View of the north side of Westchester Avenue facing northeast.



23. View of the sidewalk along the north side of Westchester Avenue facing west.



24. View of the sidewalk along the north side of Westchester Avenue facing east.





25. View of Westchester Avenue facing west toward Cooper Avenue.



26. View of the south side of Westchester Avenue facing southeast from Cooper Avenue.



27. View of Westchester Avenue facing east from Blondell Avenue.

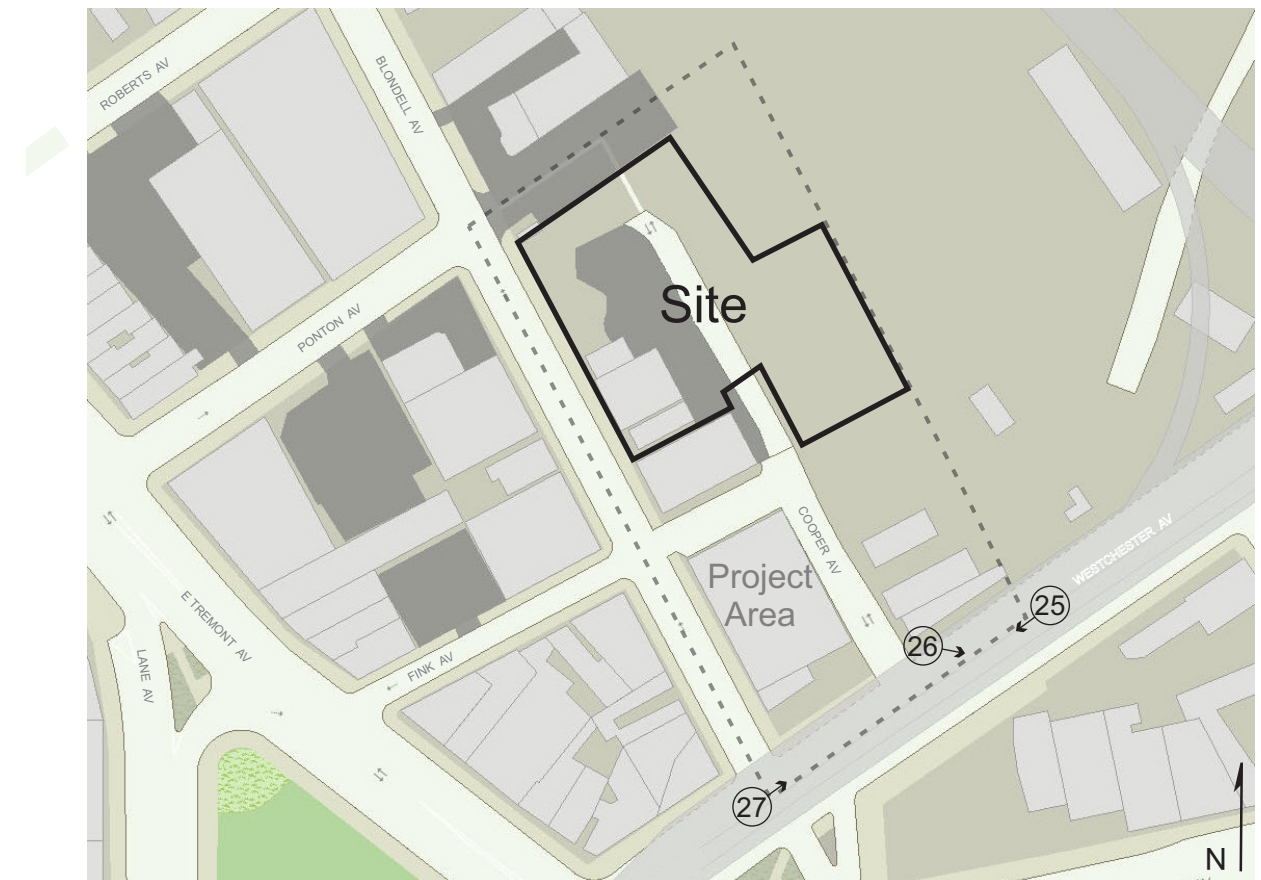



28. View of the north side of Westchester Avenue facing northwest toward Blondell Avenue.



29. View of the south side of Westchester Avenue facing south from Blondell Avenue.



30. View of Blondell Avenue facing northwest from Westchester Avenue (Site far ahead, at right).





31. View of the sidewalk along the east side of Blondell Avenue facing northwest from Westchester Avenue.



32. View of the sidewalk along the east side of Blondell Avenue facing southeast from Fink Avenue.



33. View of the east side of Blondell Avenue between Fink Avenue and Westchester Avenue facing northeast (Site at far left).





34. View of the east side of Blondell Avenue between Fink Avenue and Westchester Avenue facing southeast.



35. View of the west side of Blondell Avenue between Fink Avenue and Westchester Avenue facing northwest.

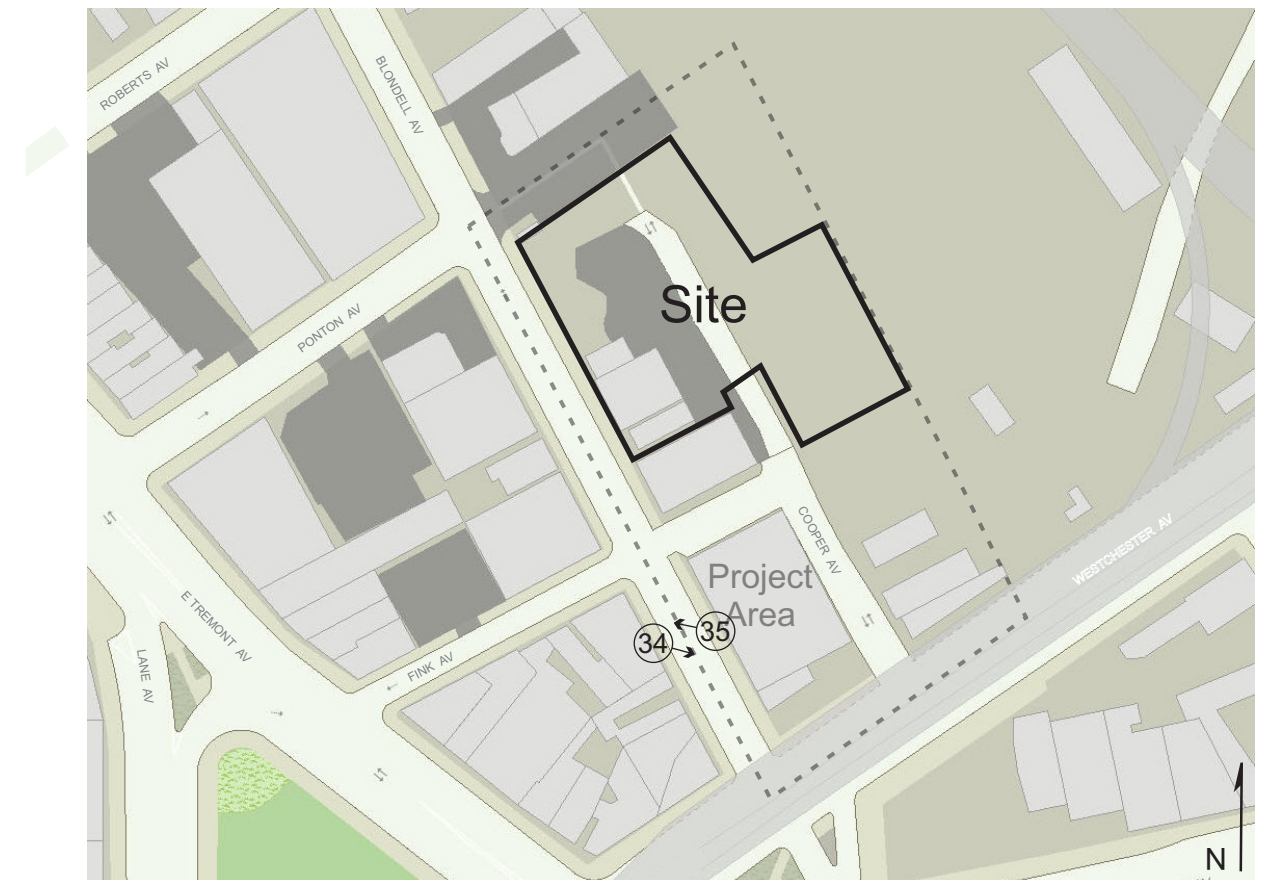

- LEGEND:**
- ← TRAFFIC DIRECTIONS
 - PROPERTY LINE
 - MERGED ZONING LOT
 - 🌳 NEW STREET TREE
 - 🌳 EXISTING STREET TREE
 - ▒ PROPOSED DEVELOPMENT
 - ▒ EXISTING BUILDINGS
 - 🚶 EXISTING CURB CUTS
 - 🕒 EXISTING TREE PIT
 - 🚒 FIRE HYDRANT
 - 🚦 SIGNS
 - 🔌 UTILITY LIGHT POLE
 - ⊕ MANHOLES
 - ⊞ GRATES

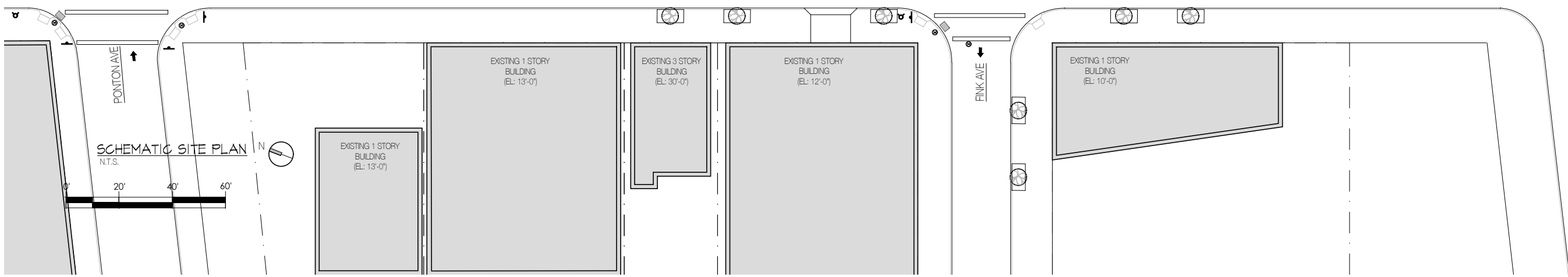

PROPOSED ZONE: R7A/C2-4
EX. ZONE: M1-1 12.23.16
BLOCK: 4133/4134 LOT: 1,2,4,62
63,70,12

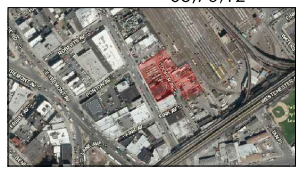

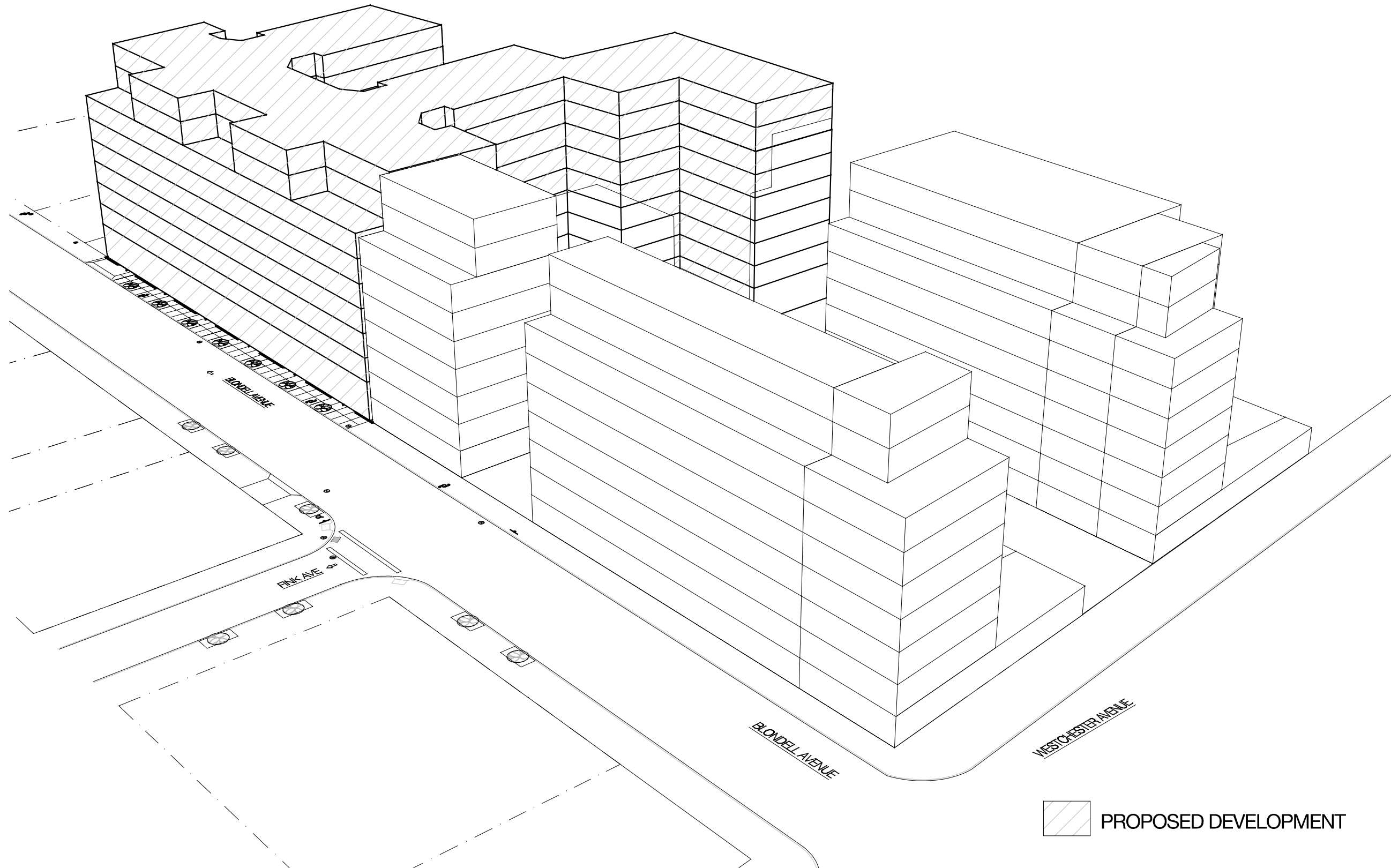

 PROPOSED DEVELOPMENT

PROPOSED ZONE: R7A/C2-4
EX. ZONE: M1-1 12.23.16
BLOCK: 4133/4134 LOT: 1,2,4,62
63,70,12

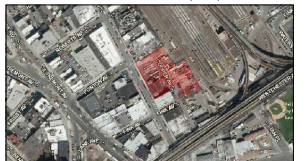

1340
BLONDELL
AVE.
BRONX, NY

AUFGANG
ARCHITECTS

PROGRESS SET
01.17.17

REZONING
AREA 3D
MASSING

PROPOSED ZONE: R7A/C2-4
EX. ZONE: M1-1 12.23.16
BLOCK: 4133/4134 LOT: 1,2,4,62
63,70,12

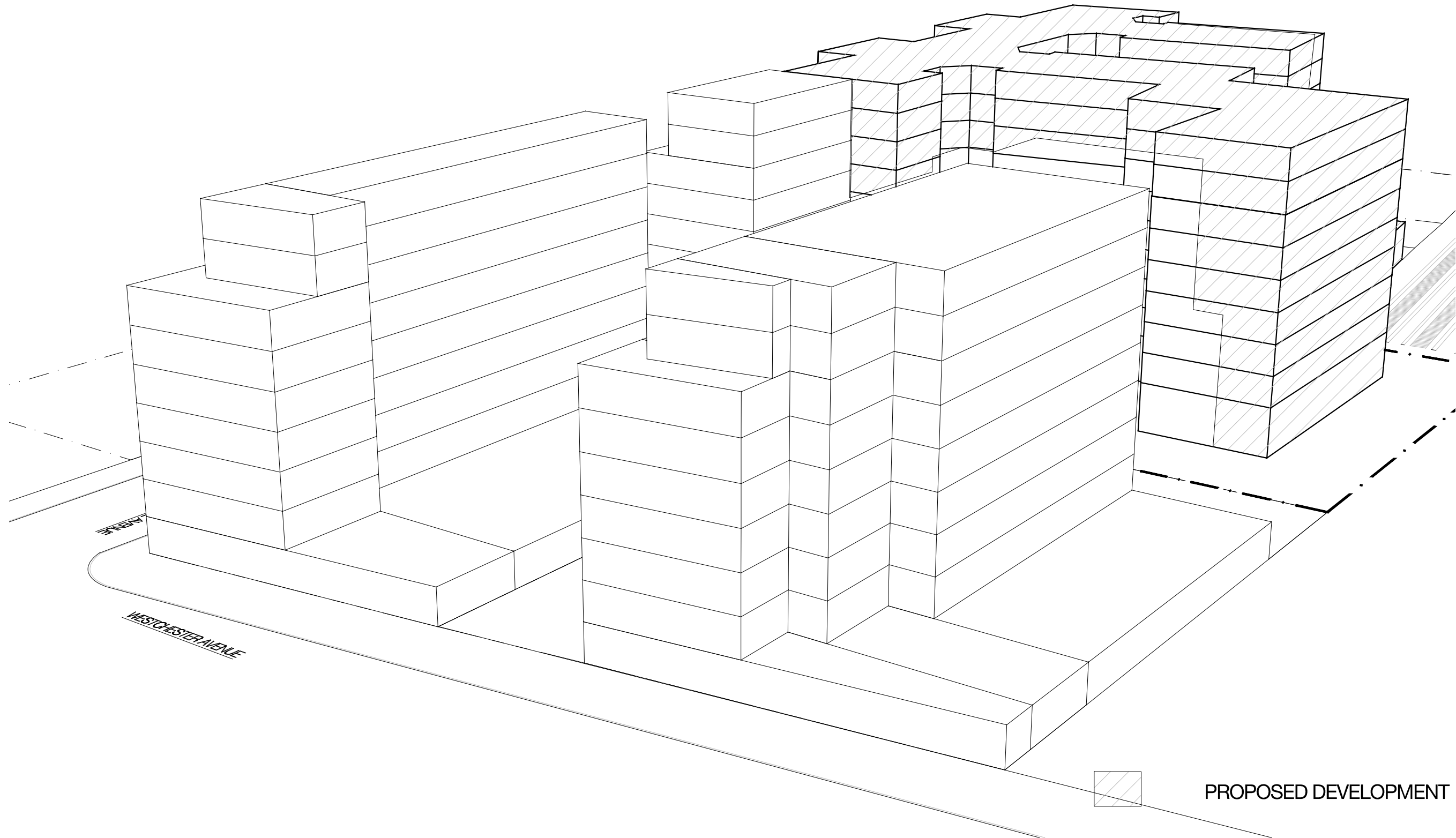
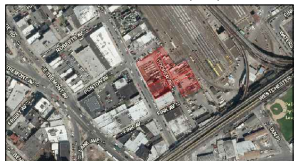

PROPOSED DEVELOPMENT

WESTCHESTER AVENUE

WESTCHESTER AVENUE

1340
BLONDELL
AVE.
BRONX, NY

AUFGANG
ARCHITECTS

PROGRESS SET
01.17.17

REZONING
AREA 3D
MASSING

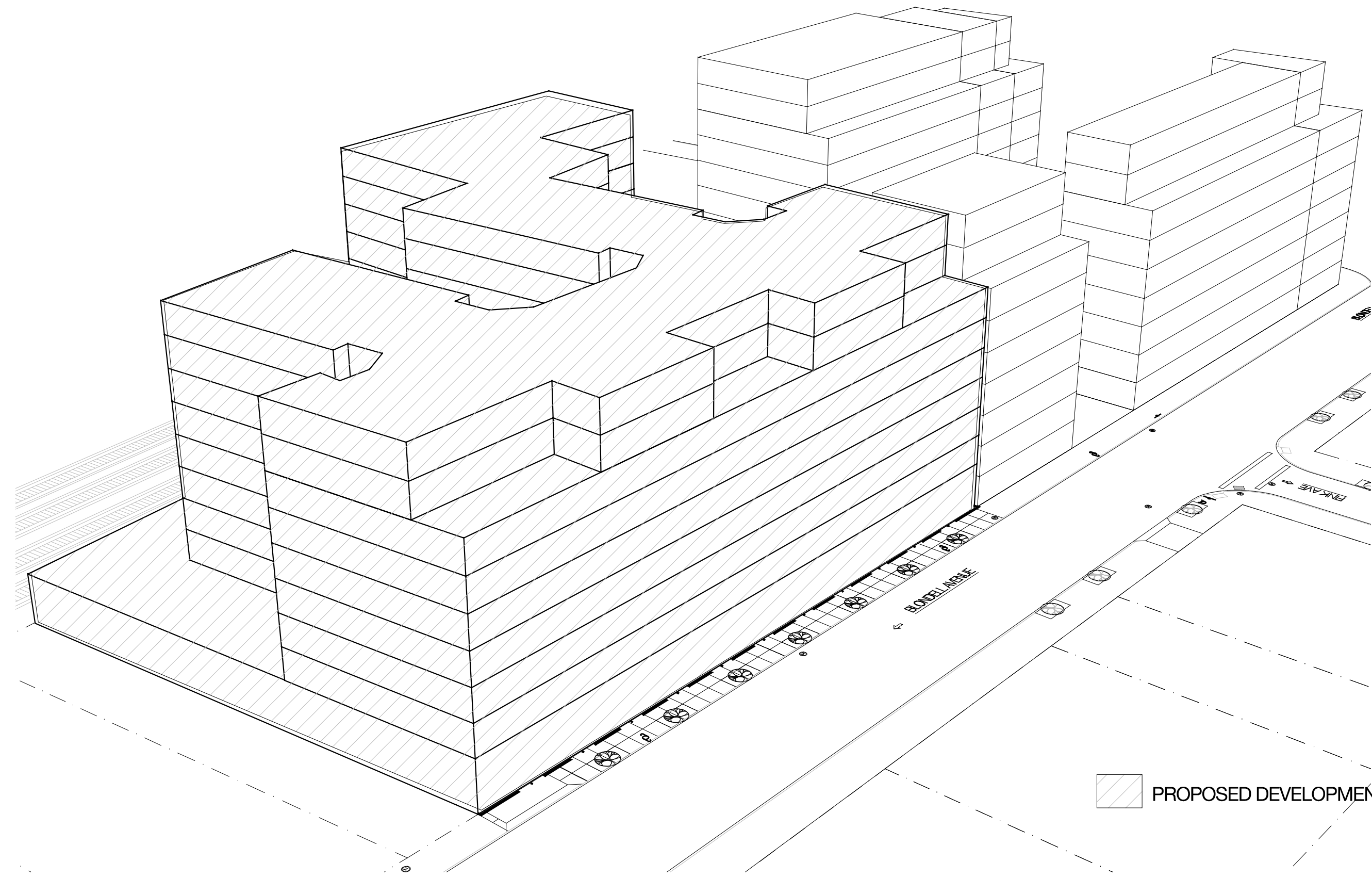

 PROPOSED DEVELOPMENT

PROPOSED ZONE: R7A/C2-4
EX. ZONE: M1-1 12.23.16
BLOCK: 4133/4134 LOT: 1,2,4,62
63,70,12



Blondell Avenue facing south (Site at left)



No-Action Scenario

Blondell Avenue facing south (Site at left)



With-Action Scenario
Block 4134 Lot 1
① Projected Development Site

Blondell Avenue facing south (Site at left)



No-Action Scenario

Blondell Avenue facing south (Site at left)

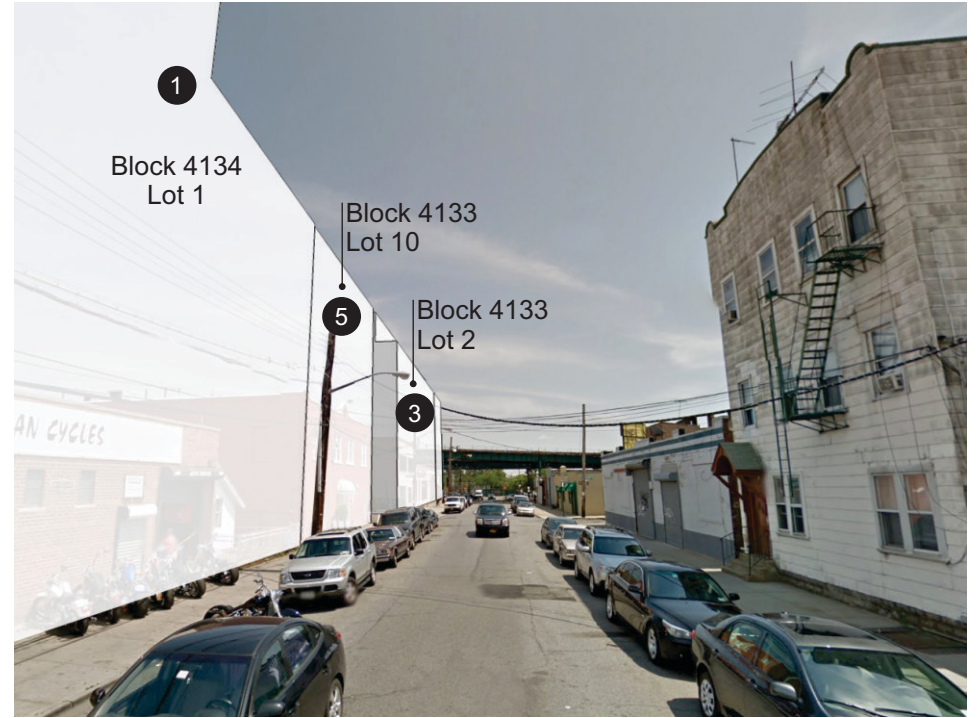

With-Action Scenario
Block 4134 Lot 10
5 Projected Development Site

Blondell Avenue facing south (Site at left)



No-Action Scenario

Blondell Avenue facing south (Site at left)

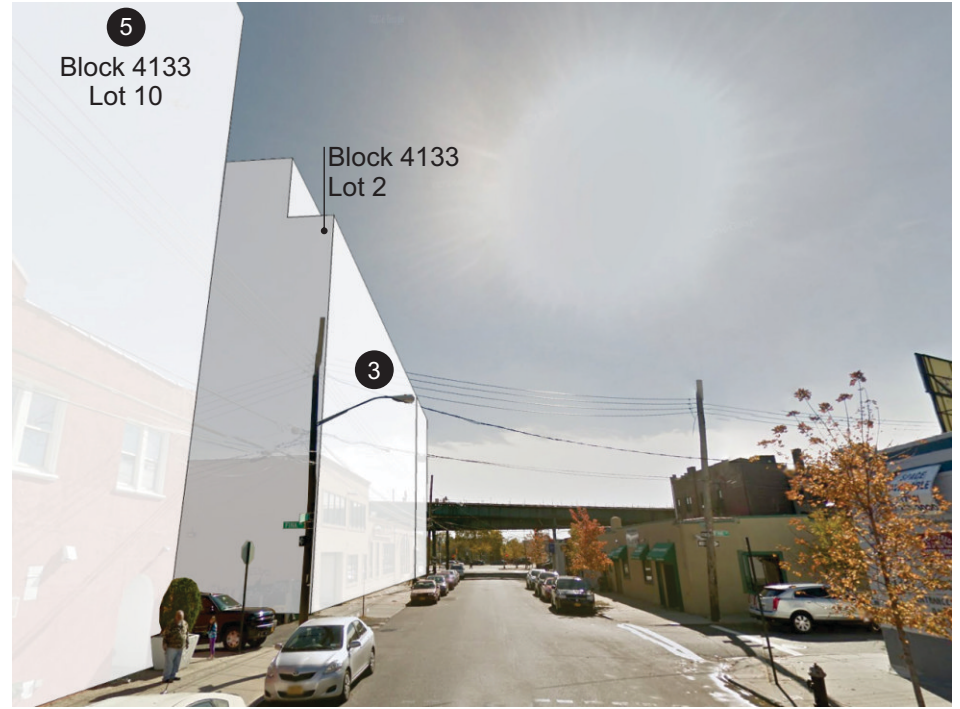

With-Action Scenario
Block 4133 Lot 2
③ Projected Development Site

Blondell Avenue facing south (Site at left)



No-Action Scenario

Blondell Avenue facing south (Site at left)



With-Action Scenario
Block 4133 Lot 1
② Projected Development Site

Cooper Avenue facing north (Site ahead)



No-Action Scenario

Cooper Avenue facing north (Site ahead)

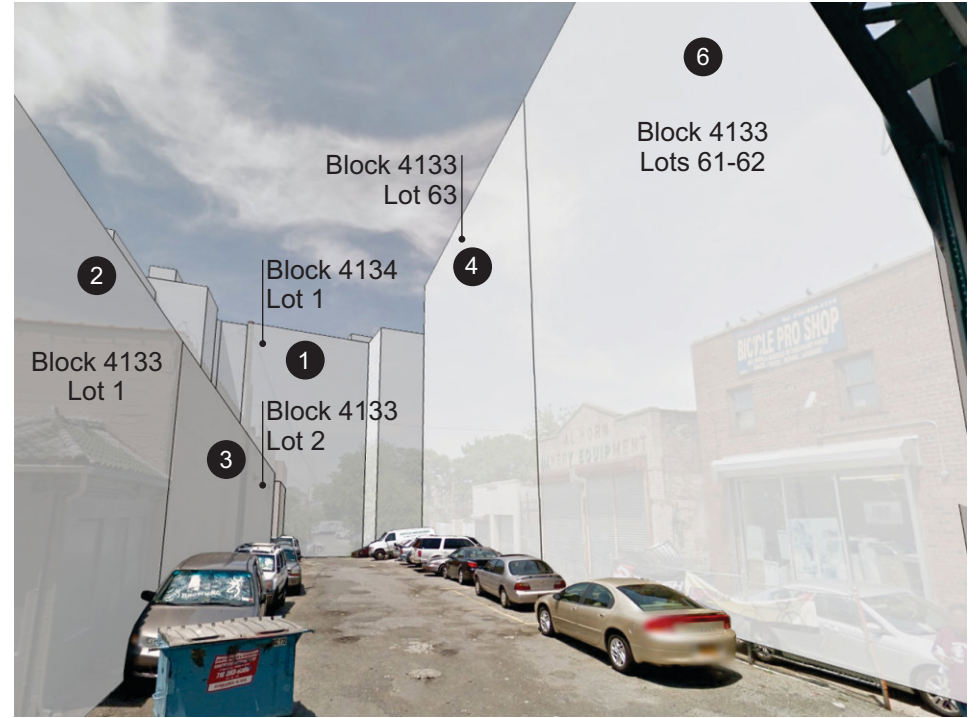

With-Action Scenario
Block 4133 Lot 63
④ Projected Development Site

Westchester Avenue facing west (Site at right)



No-Action Scenario

Westchester Avenue facing west (Site at right)



With-Action Scenario
Block 4133 Lots 61-62
⑥ Projected Development Site

12. HAZARDOUS MATERIALS

Introduction

Middleton Environmental Incorporated (MEI) has performed a Phase I Environmental Site Assessment (ESA) dated November 2, 2015 of the property located at 1338, 1340-1342, & 1344-1346 Blondell Avenue and 1342-1348 Cooper Avenue in Bronx, New York, herein referred to as the Subject Property. The main objective of this ESA was to identify Recognized Environmental Conditions (RECs), Controlled Recognized Environmental Conditions (CRECs), or Historical Recognized Environmental Conditions (HRECs) in connection with the Subject Property, defined in ASTM Practice E 1527-13 as the presence or likely presence of any hazardous substances or petroleum products that indicate an existing release, a past release, or a material threat of a release. This ESA also includes a preliminary evaluation of certain potential environmental conditions that are outside the scope of ASTM Practice E 1527- 13. This assessment has identified no evidence of CRECs or HRECs in connection with the Subject Property. However, this assessment has identified evidence of REC in connection with the Subject Property. The REC is for the storage yards at the Subject Property.

The following summarizes the findings, conclusions, and recommendations of the Phase I ESA.

Existing Conditions

The Subject Property includes six (6) rectangular-shaped parcels totaling approximately 0.88 acres. The Subject Property is currently improved with one (1) residential apartment building (1338 Blondell Avenue), one (1) commercial building (1340-1342 Blondell Avenue), one (1) residential apartment building and a storage yard (1344-1346 Blondell Avenue), and a storage yard (1342-1348 Cooper Avenue). The buildings are 6,210 square feet in total size. The 1338 Blondell Avenue building has one (1) floor, a ground level, and a partial basement and the 1340-1342 & the 1344-1346 Blondell Avenue buildings have one (1) floors, ground levels, and no basements. The 1338 Blondell Avenue building is presently vacant and formerly contained one (1) apartment unit on the main floor and on the ground level. The partial basement of the 1338 Blondell Avenue building contains a boiler area and meter and storage areas. The 1340-1342 Blondell Avenue building contains a motorcycle repair shop on the main floor and on the ground level. The motorcycle repair shop contains a retail area and a repair shop area on the main floor of the 1340-1342 Blondell Avenue building and a meter area and a storage area on the ground level of the building. The 1344-1346 Blondell Avenue building contains one (1) apartment unit on the main floor and on the ground level. The storage yards at the 1344-1346 Blondell Avenue and the 1342-1348 Cooper Avenue properties are covered with gravel and dirt pavements and are utilized for the storage of vehicles by a towing and collision company. The 1338 Blondell Avenue building was constructed on the Subject Property between 1893 and 1898; the 1340-1342 Blondell

Avenue building was constructed on the Subject Property in 1920; and the 1344-1346 Blondell Avenue building was constructed on the Subject Property prior to 1893. The buildings and the storage yards occupy the majority of the parcels, which are bordered by municipal walkways and right-of-ways. It should be noted that the 1340-1342 & 1344-1346 Blondell Avenue buildings were not accessible during the site inspection.

The current use of the adjoining properties is commercial, vacant, and mixed. The Subject Property borders are as follows:

North - The Subject Property is bordered to the north by a commercial building containing an automobile repair shop and a subway train storage yard.

South - The Subject Property is bordered to the south by a mixed-use building with a catering company on the main floor and a storage yard.

East - The Subject Property is bordered to the east by a subway train storage yard.

West - The Subject Property is bordered to the west by Blondell Avenue, a commercial building, a residential apartment building, a commercial building containing an automobile repair shop, Cooper Avenue, and a mixed-use building with a catering company on the main floor.

Regulatory Records Review

Information from standard Federal and state environmental record sources was provided through EDR. Regulatory information from the following database sources regarding possible recognized environmental conditions, within the ASTM minimum search distance from the Site, was reviewed. The following table provides a summary of the findings of the environmental database report. Specific properties identified within the database report are further discussed below.

Summary of Federal, State, and Tribal Agency Database Findings			
Regulatory Database	Approx. Minimum Search Distance	Subject Property Listed	Off-Site Listings Within Search Distance
Federal NPL Sites	1.0 mile	No	0
Federal Delisted NPL Sites	0.5 mile	No	0
Federal CERCLIS Sites	0.5 mile	No	0
Federal CERCLIS NFRAP Sites	0.5 mile	No	0
Federal RCRA CORRACTS Sites	1.0 mile	No	0
Federal RCRA Generators Sites	Property & Adjoining	No	0
Federal RCRA Non-CORRACTS TSD Sites	0.5 mile	No	0
Federal Engineering / Institutional	Property &	No	0

Control Sites	Adjoining		
Federal ERNS Sites	Subject Property	No	0
State and Tribal equivalent NPL Sites	1.0 mile	No	1
State and Tribal equivalent CERCLIS Sites	0.5 mile	No	0
State and Tribal Leaking Storage Tank Sites	0.5 mile	No	40
State and Tribal Spills Sites	Property & Adjoining	Yes	0
State and Tribal Landfill or Solid Waste Disposal Sites	0.5 mile	No	2
State and Tribal Registered Storage Tank Sites	Property & Adjoining	Yes	0
State and Tribal Engineering / Institutional Control Sites	Property & Adjoining	No	0
State and Tribal Voluntary Cleanup Sites	0.5 mile	No	0
State and Tribal Brownfield Sites	0.5 mile	No	0

State and Tribal equivalent NPL Sites

State and Tribal equivalent NPL databases were searched for sites located within 1.0 mile of the Subject Property. The Subject Property is not listed as a State and Tribal equivalent NPL Site. There was one (1) State and Tribal equivalent NPL Site within a half mile radius of the Subject Property. The Bronx Psychiatric Center site is located 0.26 of a mile northeast of the Subject Property at 1500 Waters Place. This site would not have an apparent adverse impact on the Subject Property based upon the distance to the Subject Property and direction of groundwater flow.

State and Tribal Leaking Storage Tank Sites

Leaking Storage Tank Sites are properties where releases of hazardous substances or petroleum products from underground storage tanks (USTs) and/or aboveground storage tanks (ASTs) have been identified and reported to state, tribal, or local agencies.

The Subject Property is not listed as a State and Tribal Leaking Storage Tank site. However, 40 sites located within 0.5 mile of the Subject Property were identified as State and Tribal Leaking Storage Tank Sites. Of the listed sites, 39 sites are located greater than 0.125 mile from the Subject Property and based on the distance from the Subject Property and the dense urban environment surrounding the Subject Property, these sites are considered unlikely to represent an existing release, past release, or material threat of release of hazardous substances or petroleum products on the Subject Property.

The one (1) remaining listed site located within 0.125 mile of the Subject Property has been investigated by the NYSDEC and has been closed by the NYSDEC with no further action required. Based upon the current regulatory status, separating distance,

presumed hydrogeologic gradient relative to the Subject Property, and/or reported nature/extent of contamination, it is considered unlikely that conditions associated with these identified Leaking Storage Tank sites would represent an environmental concern to the Subject Property.

State and Tribal Spills Sites

A review of the State and Tribal Spills database was conducted in order to determine whether any spills or incidents involving releases of hazardous substances or petroleum products have occurred at the Subject Property. The 1344-1346 Blondell Avenue property is listed as a State and Tribal Spills site. The New York State Department of Environmental Conservation (NYSDEC) files indicated that spill number 9710270 was issued on December 8, 1997 for the Subject Property. The Spill information indicated that a former automobile junk yard at the 1344-1346 Blondell Avenue property was burning used automobile tires and spilling oil onto the ground. A site investigation was conducted at the 1344-1346 Blondell Avenue property. This spill was fully remedied and the spill file for this incident was closed by the NYSDEC on July 14, 2003. The NYSDEC files indicated that spill number 9708308 was issued on October 8, 1997 for the Subject Property. The Spill information indicated that a former automobile junk yard at the 1344-1346 Blondell Avenue property was spilling oil from used vehicles onto the ground. The NYSDEC investigated the Spill incident and did not observe any oil stained pavements at the 1344-1346 Blondell Avenue property. This spill was fully remedied and the spill file for this incident was closed by the NYSDEC on March 5, 1998. Neither these Spill incidents nor any of the reported spills listed within a half mile of the Subject Property would have an apparent adverse impact on the Subject Property.

State and Tribal Landfill Sites and Solid Waste Disposal Sites

The State and Tribal landfill and solid waste disposal site databases identify active or inactive landfill and transfer station facilities, as well as open dumps that failed to meet RCRA Subtitle D Section 4004 criteria for solid waste landfills or disposal sites. The Subject Property is not listed as a State and Tribal landfill and solid waste disposal site. Two (2) State and Tribal landfill and solid waste disposal sites are listed within 0.5 mile of the Subject Property. The Salient Auto Salvage Inc. site is located 0.06 of a mile northwest of the Subject Property at 1374 Blondell Avenue and the Cardinal Health 414, LLC site is located 0.48 of a mile southwest of the Subject Property at 2425 Waterbury Avenue, Building #2. These sites would not have an apparent adverse impact on the Subject Property based upon the distance to the Subject Property and direction of groundwater flow.

State and Tribal Registered Storage Tank Sites

The 1344-1346 Blondell Avenue property is listed as a State and Tribal Registered Storage

Tank site. A review of the NYSDEC Petroleum Bulk Storage Tank database indicated that there was one (1) 275 gallon aboveground waste oil storage tank registered at the 1344-1346 Blondell Avenue property. The NYSDEC registration for the tank expired on December 15, 2002.

The 1338 & 1340-1342 Blondell Avenue and the 1342-1348 Cooper Avenue properties are not listed as State and Tribal Registered Storage Tank sites.

None of the adjoining properties were identified as State and Tribal Registered Storage Tank sites.

Sanborn Fire Insurance Maps, Aerial Photographs, and City Directories

Historical fire insurance maps dated 1893 to 2007, historical aerial photographs dated 1954 to 2013, and city directories dated 1931 to 2013 depicting the Subject Property were reviewed. A review of the available Sanborn Fire Insurance Maps, aerial photographs, and city directories indicated that automobile junk yards were located at the Subject Property from 1966 to 2013. No determination regarding the usage, storage, or disposal of hazardous wastes while the former automobile junk yards were in operation could be made.

Vapor Encroachment Conditions

All readily ascertainable information including all applicable Federal, State, Tribal and local database information, historical usage information, soil and groundwater sources, and information from the site reconnaissance were reviewed in order to determine if there is a possibility of a Vapor Encroachment Condition regarding the Subject Property. Based upon the results of the site reconnaissance and review of readily ascertainable information, the Vapor Encroachment Condition survey is described below.

A review of available Sanborn Fire Insurance Maps, available historical aerial photographs, and available City Directory information indicated that automobile junk yards were located at the Subject Property from 1966 to 2013. No determination regarding the usage, storage, or disposal of hazardous wastes while the former automobile junk yards were in operation could be made. Also, the 1344-1346 Blondell Avenue property is listed as a State and Tribal Spills site. The NYSDEC files indicated that spill number 9710270 was issued on December 8, 1997 for the Subject Property. The Spill information indicated that a former automobile junk yard at the 1344-1346 Blondell Avenue property was burning used automobile tires and spilling oil onto the ground. A site investigation was conducted at the 1344-1346 Blondell Avenue property. This spill was fully remedied and the spill file for this incident was closed by the NYSDEC on July 14, 2003. The NYSDEC files indicated that spill number 9708308 was issued on October 8, 1997 for the Subject Property. The Spill

information indicated that a former automobile junk yard at the 1344-1346 Blondell Avenue property was spilling oil from used vehicles onto the ground. The NYSDEC investigated the Spill incident and did not observe any oil stained pavements at the 1344-1346 Blondell Avenue property. This spill was fully remedied and the spill file for this incident was closed by the NYSDEC on March 5, 1998. Also, MEI observed several signs of minor oil staining on the gravel and dirt pavements in the storage yard areas of the Subject Property. The minor oil staining is from leaking vehicles that are stored in the storage yard areas of the Subject Property. Based on this information, the former automobile junk yards at the Subject Property are considered a Recognized Environmental Conditions (REC) for the Subject Property. Also, based on these current conditions, a vapor encroachment condition (VEC) is considered a concern with regard to the Subject Property. It is recommended that a Phase II Environmental Site Assessment be conducted in the storage yard areas of the Subject Property in order to determine if the former automobile junk yards have impacted upon the environmental quality of the Subject Property.

A review of available Sanborn Fire Insurance Maps and available historical aerial photographs and the site inspection indicated that one of the adjoining properties to the north of the Subject Property (1364 Blondell Avenue) contains a commercial building containing an automobile repair shop from 1950 to present. However, this commercial building contained a former gasoline service station from 1950 to 1988. A review of the environmental database did not indicate any listings at this site. This site is located upgradient of the Subject Property and this site does not appear to have any adverse impact upon the Subject Property. It should be noted that any contamination from this site would be the responsibility of the owner of this site and not the owner of the Subject Property.

Local Regulatory Agency Records

Local municipal offices consulted during the completion of this assessment included the New York City Building Department, the New York City Department of Finance, and the New York City Fire Department (NYCFD). Information was reviewed in order to determine the possibility of documented adverse environmental conditions, violations, or complaints associated with the Subject Property.

The information provided by New York City Department of Finance and New York City Building Department did not identify any conditions or reported events that would indicate the presence of a recognized environmental condition in connection with the Subject Property.

MEI reviewed information provided by the NYCFD. Specific information obtained from the NYCFD includes any active and/or voided storage tank permits for the Subject Property. A review of the NYCFD storage tanks files indicated that there were no

“active” tank accounts for any underground or aboveground storage tanks at the Subject Property.

Property Reconnaissance

Underground Storage Tanks

MEI did not observe any fill ports or vent pipes for any underground storage tanks on the Subject Property. A review of the NYSDEC Petroleum Bulk Storage Tank database did not indicate the presence of any registered underground storage tanks at the Subject Property. A review of the NYCFD storage tanks files indicated that there were no “active” tank accounts for any underground storage tanks on the Subject Property. Available Sanborn Fire Insurance Maps did not indicate the presence of any buried tanks on the Subject Property.

Aboveground Storage Tanks

MEI did not observe any aboveground storage tanks at the Subject Property. A review of NYCFD storage tanks files indicated that there were no “active” tank accounts for any aboveground storage tanks on the Subject Property. The 1344-1346 Blondell Avenue property is listed as a State and Tribal Registered Storage Tank site. A review of the NYSDEC Petroleum Bulk Storage Tank database indicated that there was one (1) 275 gallon aboveground waste oil storage tank registered at the 1344-1346 Blondell Avenue property. The NYSDEC registration for the tank expired on December 15, 2002. The tank is associated with a former automobile junk yard at the 1344-1346 Blondell Avenue property. MEI did not observe the 275 gallon aboveground waste oil storage tank at the Subject Property and the tank was probably removed from the Subject Property in the past. A review of the NYSDEC Petroleum Bulk Storage Tank database did not indicate the presence of any registered aboveground storage tanks at the 1338 & 1340-1342 Blondell Avenue and the 1342-1348 Blondell Avenue property. The 1338 Blondell Avenue building was heated by a natural gas fired heating system that is located inside the boiler area in the partial basement of the 1338 Blondell Avenue building. The 1340-1342 and the 1344-1346 Blondell Avenue buildings are presently heated by natural gas fired heating systems that are located inside the buildings.

Hazardous Substances and Petroleum Products

MEI observed one (1) 55 gallon drum of waste oil inside the repair shop area for the motorcycle repair shop on the main floor of the 1340-1342 Blondell Avenue building. MEI observed one (1) 55 gallon of unknown liquid in the storage yard area. MEI did not observe any signs of staining or leakage in the vicinity of the 55 gallon drums. MEI did not observe any hazardous substances or petroleum products at the Subject Property.

Other Physical Observations

MEI did not observe any of the following at the Subject Property:

- *Non-Hazardous Substances and Petroleum Products*
- *Unidentified Substances Containers*
- *Drains or Storm Water Drywells*
- *PCB-containing Equipment*
- *Stains or Corrosion*
- *Odors*
- *Pools of Liquid*
- *Stressed Vegetation*
- *Wells*
- *Sumps, Pits, Ponds, or Lagoons*
- *Improper Disposal of Waste Water*

MEI observed the following at the Subject Property:

- *Stained Soil or Pavement*

MEI observed several signs of minor oil staining on the gravel and dirt pavements in the storage yard areas. The minor oil staining is from leaking vehicles that are stored in the storage yard areas. MEI did not observe any additional stained soil at the Subject Property.

- *Solid Wastes Disposal*

All solid wastes generated on-site are carted away by a licensed waste hauler to an approved solid waste facility and are not disposed at on-site.

Conditions Outside the Scope of ASTM Practice 1527-13

Asbestos Containing Material (ACM)

It should be noted that the limited visual screening survey conducted under the scope of work for this assessment does not constitute a full asbestos inspection, in which all areas of the buildings would have been thoroughly surveyed and sampled. MEI did not observe any signs of ACM inside the accessible areas of the buildings. MEI observed signs of non-friable ACM in the asbestos exterior shingles on the exterior walls of the 1338 Blondell Avenue building. This material was in fair to good condition and removal is not recommended. MEI did not observe any signs of ACM spray-on fireproofing inside the accessible areas of the buildings. However, prior to any demolition work conducted on the buildings at the Subject Property, it is recommended that an asbestos survey be completed to confirm the presence, or absence of asbestos in all suspect material. All materials confirmed to be asbestos containing should be removed in accordance with applicable local and State regulations.

Lead Based Paint (LBP)

MEI observed signs of peeling paint and water damage on the walls and ceilings inside the vacant apartment unit on the main floor and on the ground level of the 1338 Blondell Avenue building. Since the 1338 Blondell Avenue building is proposed to be demolished, it is recommended that these areas do not need to be repaired or repainted. A review of the New York City Department of Housing Preservation and Development's (NYCHPD) Code Enforcement Database did not indicate the presence of any outstanding lead based paint violations regarding the Subject Property. However, prior to any demolition work conducted on the buildings at the Subject Property, it is recommended that a complete survey be completed to confirm the presence or absence of lead based paint on all surfaces. All materials confirmed to have lead based paint should be removed in accordance with applicable local and State regulations for lead based paint abatement.

Lead in Drinking Water

MEI did not observe any brass fixtures or lead fixtures at the Subject Property.

Radon

The U.S. Environmental Protection Agency's Map of Radon Zones identified the Subject Property as a radon zone Level 3. Level 3 signifies that the average predicted radon level indoors is less than 2 pico-Curies per liter and this is the lowest level in the state. This level compares favorably with the EPA action level of 4.0 pico-Curies per liter as the guideline (it should be noted that current radon information and EPA Action Levels are designated for residential spaces only and commercial and industrial facilities are not subject to EPA's Action Level of 4 pico-Curies per liter as the guideline and definitive information concerning radon gas in an individual building can only be obtained through long term testing).

Mold

As part of this assessment, MEI performed a limited visual inspection for the conspicuous presence of mold. MEI observed the accessible interior areas of the Subject Property structure(s), including interior walls and ceilings of the vacant apartment unit on the main floor and on the ground level of the 1338 Blondell Avenue building, the partial basement of the 1338 Blondell Avenue building and the motorcycle repair shop on the main floor and on the ground level of the 1340-1342 Blondell Avenue building for the presence of conspicuous mold or observed water intrusion or accumulation. This evaluation did not include a review of pipe chases or areas behind enclosed walls and ceilings. MEI did not observe conspicuous visual or olfactory indications of the presence of mold, nor did MEI observe obvious indications of significant water damage inside the accessible areas of the buildings.

Findings, Opinions, and Recommendations

MEI has performed this Phase I Environmental Site Assessment of the Subject Property in conformance with the scope and limitations of ASTM Standard E 1527-13. This assessment has identified no evidence of Controlled Recognized Environmental Conditions (CRECs) and Historical Recognized Environmental Conditions (HRECs) in connection with the Subject Property. This assessment has identified evidence of a Recognized Environmental Condition (REC) in connection with the Subject Property. The REC is for the storage yards at the Subject Property.

The site reconnaissance, interviews, and review of records have found the presence or possible presence of hazardous substances or petroleum related products in, on, or at the Subject Property due to any release to the environment; under conditions indicative of a release to the environment; or under conditions that pose a material threat of a future release to the environment.

A review of available Sanborn Fire Insurance Maps, available historical aerial photographs, and available City Directory information indicated that automobile junk yards were located at the Subject Property from 1966 to 2013. No determination regarding the usage, storage, or disposal of hazardous wastes while the former automobile junk yards were in operation could be made. Also, the 1344-1346 Blondell Avenue property is listed as a State and Tribal Spills site. The NYSDEC files indicated that spill number 9710270 was issued on December 8, 1997 for the Subject Property. The Spill information indicated that a former automobile junk yard at the 1344-1346 Blondell Avenue property was burning used automobile tires and spilling oil onto the ground. A site investigation was conducted at the 1344-1346 Blondell Avenue property. This spill was fully remedied and the spill file for this incident was closed by the NYSDEC on July 14, 2003. The NYSDEC files indicated that spill number 9708308 was issued on October 8, 1997 for the Subject Property. The Spill information indicated that a former automobile junk yard at the 1344-1346 Blondell Avenue property was spilling oil from used vehicles onto the ground. The NYSDEC investigated the Spill incident and did not observe any oil stained pavements at the 1344-1346 Blondell Avenue property. This spill was fully remedied and the spill file for this incident was closed by the NYSDEC on March 5, 1998. Also, MEI observed several signs of minor oil staining on the gravel and dirt pavements in the storage yard areas of the Subject Property. The minor oil staining is from leaking vehicles that are stored in the storage yard areas of the Subject Property. Based on this information, the former automobile junk yards at the Subject Property are considered a Recognized Environmental Conditions (REC) for the Subject Property. Also, based on these current conditions, a vapor encroachment condition (VEC) is considered a concern with regard to the Subject Property. It is recommended that a Phase II Environmental Site Assessment be conducted in the storage yard areas of the Subject Property in order to

determine if the former automobile junk yards have impacted upon the environmental quality of the Subject Property.

The only conditions outside of ASTM E 1527-13 that were identified in connection with the Subject Property were signs of non-friable ACM in the asbestos exterior shingles on the exterior walls of the 1338 Blondell Avenue building. This material was in fair to good condition and removal is not recommended. However, prior to any demolition work conducted on the buildings at the Subject Property, it is recommended that an asbestos survey be completed to confirm the presence, or absence of asbestos in all suspect material. All materials confirmed to be asbestos containing should be removed in accordance with applicable local and State regulations.

Lastly, MEI observed signs of peeling paint and water damage on the walls and ceilings inside the vacant apartment unit on the main floor and on the ground level of the 1338 Blondell Avenue building. Since the 1338 Blondell Avenue building is proposed to be demolished, it is recommended that these areas do not need to be repaired or repainted. A review of the NYCHPD Code Enforcement Database did not indicate the presence of any outstanding lead based paint violations regarding the Subject Property. However, prior to any demolition work conducted on the buildings at the Subject Property, it is recommended that a complete survey be completed to confirm the presence or absence of lead based paint on all surfaces. All materials confirmed to have lead based paint should be removed in accordance with applicable local and State regulations for lead based paint abatement.

Conclusions

In lieu of a Phase II workplan, an "E" designation for hazardous materials will be placed on the zoning map pursuant to Section 11-15 of the New York City Zoning Resolution for the subject property. The "E" designation will ensure that testing and mitigation will be provided as necessary before any future development and/or soil disturbance on the property. The Applicant will be directed to coordinate further hazardous materials assessments through the Mayor's Office of Environmental Remediation.

Therefore, in order to avoid any potential impacts associated with hazardous materials, an (E) designation (E-505) will be assigned for hazardous materials on the following property:

Block 4134, Lot 1

The text for the (E) designations related to hazardous materials is as follows:

Task 1-Sampling Protocol

The applicant submits to OER, for review and approval, a Phase I of the site along with a soil, groundwater and soil vapor testing protocol, including a description of methods and a site map with all sampling locations clearly and precisely represented. If site sampling is necessary, no sampling should begin until written approval of a protocol is received from OER. The number and location of samples should be selected to adequately characterize the site, specific sources of suspected contamination (i.e., petroleum based contamination and non-petroleum based contamination), and the remainder of the site's condition. The characterization should be complete enough to determine what remediation strategy (if any) is necessary after review of sampling data. Guidelines and criteria for selecting sampling locations and collecting samples are provided by OER upon request.

Task 2-Remediation Determination and Protocol

A written report with findings and a summary of the data must be submitted to OER after completion of the testing phase and laboratory analysis for review and approval. After receiving such results, a determination is made by OER if the results indicate that remediation is necessary. If OER determines that no remediation is necessary, written notice shall be given by OER.

If remediation is indicated from test results, a proposed remediation plan must be submitted to OER for review and approval. The applicant must complete such remediation as determined necessary by OER. The applicant should then provide proper documentation that the work has been satisfactorily completed.

A construction-related health and safety plan should be submitted to OER and would be implemented during excavation and construction activities to protect workers and the community from potentially significant adverse impacts associated with contaminated soil, groundwater and/or soil vapor. This plan would be submitted to OER prior to implementation.

With this (E) designation in place, no significant adverse impacts related to hazardous materials are expected, and no further analysis is warranted. Therefore, there is no potential for the Proposed Actions to result in significant adverse impacts related to hazardous materials on Projected Development Site 1.

Projected Development Sites 2 through 6

Projected Development Sites 2 through 6 are not under the control or ownership of the Applicant and they are not included in the proposed development plans for this project. An "E" designation for hazardous materials will be placed on the zoning map pursuant to Section 11-15 of the New York City Zoning Resolution for the subject properties. The

"E" designation will ensure that testing and mitigation will be provided as necessary before any future development and/or soil disturbance on these properties. These applicant(s) should be directed to coordinate further hazardous materials assessments through the Mayor's Office of Environmental Remediation.

Therefore, in order to avoid any potential impacts associated with hazardous materials, an (E) designation (E-505) will be assigned for hazardous materials on the following properties:

Block 4133, Lots 1, 2, 10, 61, 62, 63

The text for the (E) designations related to hazardous materials is as follows:

Task 1-Sampling Protocol

The Applicant submits to OER, for review and approval, a Phase I of the site along with a soil, groundwater and soil vapor testing protocol, including a description of methods and a site map with all sampling locations clearly and precisely represented. If site sampling is necessary, no sampling should begin until written approval of a protocol is received from OER. The number and location of samples should be selected to adequately characterize the site, specific sources of suspected contamination (i.e., petroleum based contamination and non-petroleum based contamination), and the remainder of the site's condition. The characterization should be complete enough to determine what remediation strategy (if any) is necessary after review of sampling data. Guidelines and criteria for selecting sampling locations and collecting samples are provided by OER upon request.

Task 2-Remediation Determination and Protocol

A written report with findings and a summary of the data must be submitted to OER after completion of the testing phase and laboratory analysis for review and approval. After receiving such results, a determination is made by OER if the results indicate that remediation is necessary. If OER determines that no remediation is necessary, written notice shall be given by OER.

If remediation is indicated from test results, a proposed remediation plan must be submitted to OER for review and approval. The Applicant must complete such remediation as determined necessary by OER. The Applicant should then provide proper documentation that the work has been satisfactorily completed.

A construction-related health and safety plan should be submitted to OER and would be implemented during excavation and construction activities to protect workers and the community from potentially significant adverse impacts

associated with contaminated soil, groundwater and/or soil vapor. This plan would be submitted to OER prior to implementation.

With this (E) designation in place, no significant adverse impacts related to hazardous materials are expected, and no further analysis is warranted. Therefore, there is no potential for the Proposed Actions to result in significant adverse impacts related to hazardous materials on Projected Development Sites 2 through 6.

16. TRANSPORTATION

I. Introduction

This analysis examines the potential traffic, transit, pedestrian, and safety impacts associated with the future with-action development of 1340 Blondell Avenue (the “Project Site”) in the Westchester Square section of the Bronx, New York. (See Exhibit 16-1, Project Area.) The Proposed Actions seek to rezone several lots on Blocks 4133 and 4134 in the existing M1-1 and creating a R7-A/C2-4 (M.I.H.) to facilitate the development of new mixed-use buildings. It is important to note that there are six (6) projected development sites in the Project Area: one (1) is applicant-owned and the remaining five (5) are soft sites. In total, the Proposed Actions would facilitate the development of approximately net new 380 residential dwelling units, 9,025 gsf of new commercial/retail use, 2,024 gsf of community facility space, and 265 total net new off-street parking spaces. Based on the anticipated construction schedule, the applicant-owned site would be developed in 2022 while the remaining soft sites are projected to be developed by 2029. Note that the build year for the subject analysis is 2029 and considers the total impact of the Proposed Actions. A comparison of the existing/no-action and 2029 with-action development is provided in Table 16-1.

Table 16-1: Comparison of Existing/No-Action and 2029 With-Action Development Scenarios

Development Site	Land Use	Existing/No-Action	2029 With-Action	Increment	
1	Residential	1 DU (Vacant)	228 DU	+228 DU	
	Local Retail	--	19,668 GSF	+19,668 SF	
	Community Facility	Medical Office	--	1,012 GSF	+1,012 GSF
		Day Care Center	--	1,012 GSF	+1,012 GSF
	<i>Parking Supply</i>	--	--	225 Spaces	
	Auto Repair Facility	4,500 GSF	--	-4,500 GSF	
	Office	944 GSF	--	-944 GSF	
2	Residential	--	13 DU	+13 DU	
	Local Retail	--	1,930 GSF	+1,930 GSF	
	Auto Repair Facility	1,075 GSF	--	-1,075 GSF	
3	Residential	--	49 DU	+49 DU	
	Local Retail	--	10,557 GSF	+10,577 GSF	
	<i>Parking Supply</i>	--	19 Spaces	+19 Spaces	
	Office & Garage	24,900 GSF	--	-24,900 GSF	
4	Residential	--	53 DU	+53 DU	
	Local Retail	--	9,270 GSF	+9,270 GSF	

	<i>Parking Supply</i>	--	<i>21 Spaces</i>	<i>+21 Spaces</i>
	Storage	1,200 GSF	--	-1,200 GSF
5	Residential	4 DU	22 DU	+18 DU
	Local Retail	8,820 GSF	4,068 SF	-4,752 GSF
6	Residential	--	19 DU	+19 DU
	Local Retail/Office	5,040 GSF	3,236 SF	-1,804 GSF
TOTAL	Residential	5 DU	384 DU	+380 DU
	Local Retail, Office	39,724 GSF	48,729 GSF	+9,025 GSF
	Community Facility	--	2,024 GSF	+2,024 GSF
	<i>Parking Supply</i>	--	<i>265 Spaces</i>	<i>+265 Spaces</i>
	Auto Repair, Storage	6,775 GSF	--	-6,775 GSF

The Project Site is bounded by Blondell Avenue, Ponton Avenue, Westchester Avenue, and the NYC Transit Yard in the Westchester Square neighborhood of the Bronx, Community District 11. The Project Site contains a variety of active and dormant uses but is predominantly utilized for automotive service and storage. Four (4) peak hours were considered for the transportation analysis: weekday morning, weekday midday, weekday evening, and Saturday midday.

2. Study Area

To assess the potential for transportation impacts to result from the Proposed Actions, the study area was defined based on principal access routes to and from the project site, traffic conditions in the surrounding area, and key intersections most likely to be affected by trips generated by the Proposed Actions. A safety assessment was also conducted for the study area. The geographic location of the study area is depicted in Exhibit 16-2.

Roadway Characteristics

The physical and operational characteristics of the major roadways in the study area are as follows:

- Blondell Avenue is a local one-way roadway that operates with one (1) travel lane in the northbound direction and curbside parking on both sides of the street. Vehicular access to the underground parking area associated with the applicant-owned development site would be provided along Blondell Avenue.
- Fink Avenue is a local one-way roadway that operates with one (1) travel lane in the westbound direction and curbside parking on both sides of the street. Fink Avenue extends east of Blondell Avenue and intersects Cooper Avenue. Note that Fink Avenue and Cooper Avenue are presently underdeveloped, and a portion of Fink Avenue would be demapped as part of the Proposed Actions.
- Ponton Avenue is a local one-way roadway that operates with one (1) travel lane in the eastbound direction and curbside parking on both sides of the street.

- Saint Raymond Avenue is a local two-way roadway with its easterly terminus at the intersection with Blondell Avenue. Given the one-way orientation of the roadways intersecting Blondell Avenue in the site vicinity and the intersection formed by East Tremont Avenue and Williamsbridge Road, Saint Raymond Avenue provides access to both directions of Williamsbridge Avenue and East Tremont Avenue in the site vicinity.
- Westchester Avenue is a two-way, north-south roadway that operates with one (1) to two (2) travel lanes in each direction and curbside parking on both sides of the street. The NYCT/MTA No. 6 Subway train is elevated above the roadway. Additionally, the NYCT/MTA Bx8, Bx21, and Bx24 bus routes provide service on this roadway.
- East Tremont Avenue is a two-way roadway, east-west roadway that operates with one (1) to two (2) travel lanes in each direction and curbside parking on both sides of the street. The NYCT/MTA Bx4a, Bx8, Bx24, Bx31, Bx40, and Bx42 bus routes provide service on this roadway.

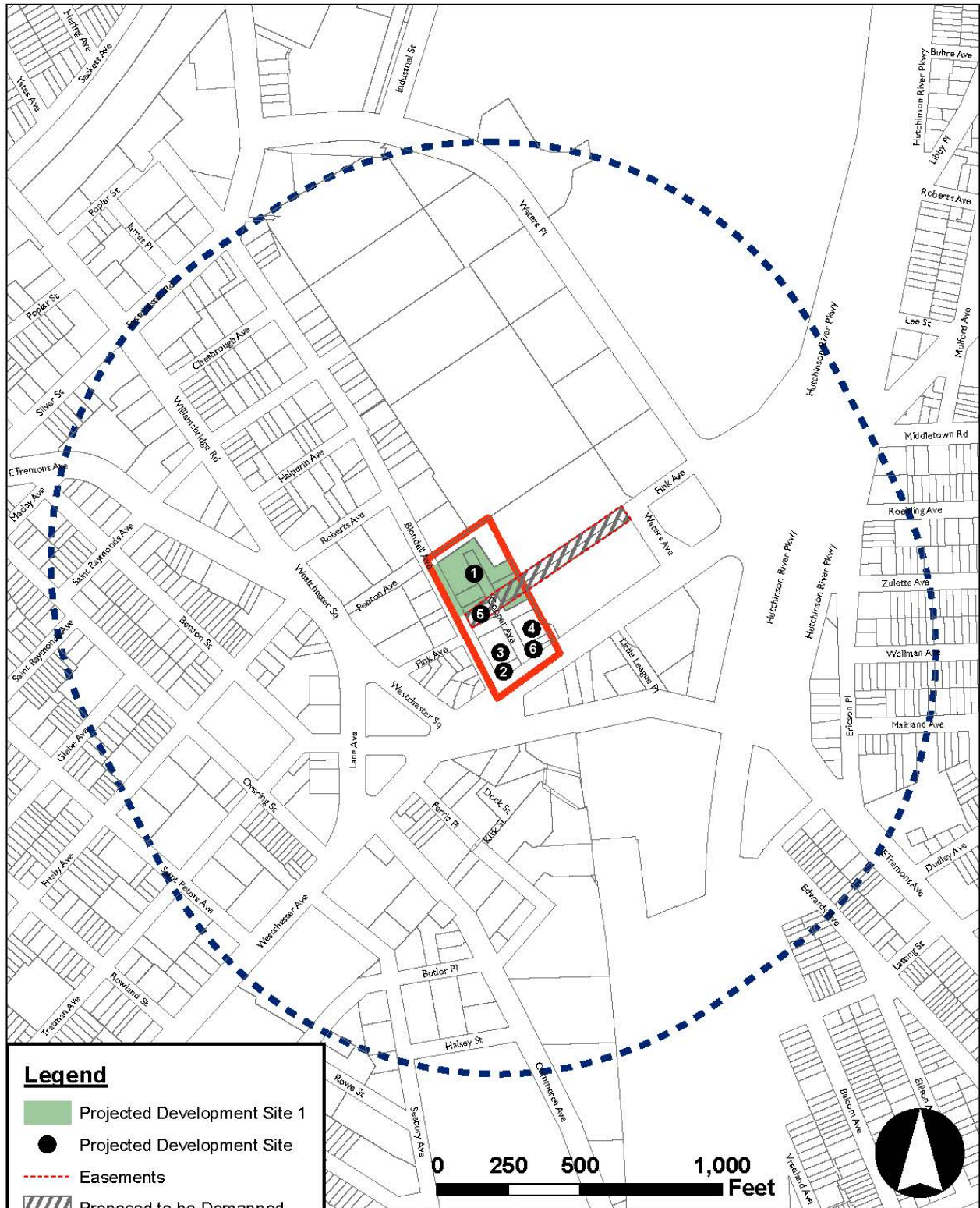

Legend

- Projected Development Site 1
- Projected Development Site
- Easements
- Proposed to be Demapped
- Rezoning Area Boundary
- 1/4 Mile Study Area

Exhibit 16-1: Project Area

Transit Elements

Transit elements in the study area include one (1) subway line and eight (8) bus routes, as shown on Exhibit 16-3.

Subway Elements

The No. 6 IRT line of the MTA's NYC Subway System operates within the study area and serves the Westchester Square – East Tremont Avenue Station located less than ¼-mile from the Project Area, as shown on Exhibit 16-3.

Bus Elements

Eight (8) MTA/NYCT local bus routes provide regular bus service within the study area including the Bx4/Bx4A, Bx8, Bx21, Bx24, Bx31, Bx40, and Bx42. Each bus route is briefly described below and shown graphically on Exhibit 16-3 (Appended Sheet A5).

- Bx4/Bx4A provides mobility between The Hub and Westchester Square in the Bronx and operates in the site vicinity along Lane Avenue, East Tremont Avenue, and Westchester Avenue. The Bx4/Bx4A route provides service between 5:00 a.m. and 1:51 a.m. Headways on the Bx4/Bx4A are generally 7-8 minutes during the weekday peak periods and 10 minutes during the Saturday peak period. The Bx4/Bx4A bus stops on Lane Avenue between Williamsbridge Road and Westchester Avenue.
- Bx8 provides mobility between Williamsbridge and Locust Point in the Bronx and operates in the site vicinity along Williamsbridge Road, East Tremont Avenue, and Westchester Avenue. The Bx8 route provides service between 5:33 a.m. and 11:00 p.m. Headways on the Bx8 are generally 8-10 minutes during the weekday peak periods and 30 minutes during the Saturday peak period. The Bx8 bus stops on Westchester Square between Fink Avenue and Westchester Avenue, and on Westchester Avenue between Westchester Square and Blondell Avenue.
- Bx21 provides mobility between Westchester Square and Mott Haven in the Bronx and operates in the site vicinity along Westchester Avenue. The Bx21 route provides 24-hour service. Headways on the Bx21 are generally 6 minutes during the weekday peak periods and 12 minutes during the Saturday peak period. The Bx21 bus stops on Westchester Avenue between Westchester Square and Lane Avenue.
- Bx24 provides mobility between Country Club and Hutchinson Metro Center in the Bronx and operates in the site vicinity along Williamsbridge Road and Westchester Avenue. The Bx24 route provides 24-hour service. Headways on the Bx24 are generally 30 minutes during the weekday peak periods and 30 minutes during the Saturday peak period. The Bx24 bus stops on Westchester Avenue between Blondell Avenue and Westchester Square.

- Bx31 provides mobility between Westchester Square and Woodlawn in the Bronx and operates in the site vicinity along Williamsbridge Road and East Tremont Avenue. The Bx31 route provides service between 4:40 a.m. and 12:45 a.m. Headways on the Bx31 are generally 10 minutes during the weekday peak periods and 15 minutes during the Saturday peak period. The Bx31 bus stops on Westchester Square between Lane Avenue and Westchester Avenue.
- Bx40 provides mobility between Morris Heights and Fort Schuyler in the Bronx and operates in the site vicinity along East Tremont Avenue. The Bx40 route provides 24-hour service. Headways on the Bx40 are generally 15 minutes during the weekday peak periods and 24 minutes during the Saturday peak period. The Bx40 bus stops on East Tremont Avenue between Fink Avenue and Westchester Avenue.
- Bx42 provides mobility between Morris Heights and Throgs Neck in the Bronx and operates in the site vicinity along East Tremont Avenue. The Bx42 route provides 24-hour service. Headways on the Bx42 are generally 15 minutes during the weekday peak periods and 24 minutes during the Saturday peak period. The Bx42 bus stops on East Tremont Avenue between Fink Avenue and Westchester Avenue.

Traffic Intersections

The following intersections were studied as part of the vehicular analysis performed in association with the Proposed Actions:

- Unsignalized intersection of Blondell Avenue and Ponton Avenue;
- Unsignalized intersection of Blondell Avenue and Saint Raymond Avenue;
- Signalized intersection of Blondell Avenue and Westchester Avenue; and
- Signalized intersection of Westchester Avenue and East Tremont Avenue.

Pedestrian Elements

The following pedestrian elements were studied as part of the pedestrian analysis performed in association with the Proposed Actions:

Sidewalk along the easterly side of Blondell Avenue between Fink Avenue and Ponton Avenue. In the existing/no-action condition, this sidewalk is approximately 8' feet wide. As part of the Proposed Actions, the sidewalk would be improved to be 11-feet-wide but tree pits are proposed along the site frontage reducing the effective width to 6 feet in areas.

- The crosswalk across Fink Avenue on the easterly side of Blondell Avenue. In

the existing/no-action condition, this crosswalk is approximately 9 feet wide. As part of the Proposed Actions, the crosswalk would be improved to be 11-foot-wide.

- The northeast corner of the intersection of Blondell Avenue and Fink Avenue which has an approximately 12-foot radius. Please note that a utility pole obstructs approximately 5 square-feet of circulation area at the subject corner.
- Sidewalk along the easterly side of Blondell Avenue between Fink Avenue and Westchester Avenue. In the existing/no-action condition, this sidewalk is 8 feet wide. As part of the Proposed Actions, the sidewalk would be improved to be 11 feet wide. At this time, tree pits are not proposed along the soft sites located along Blondell Avenue.
- The northeast corner of the intersection of Blondell Avenue and Westchester Avenue which has an approximately 12-foot radius. Please note that utility poles and train support columns obstruct approximately 7 square-feet of circulation area at the subject corner.
- Sidewalk along the northerly side of Westchester Avenue between East Tremont Avenue and the entrance to the NYCT/MTA No. 6 Subway train. In the existing/no-action condition, this crosswalk is 13.5 feet wide and would be maintained in the future.

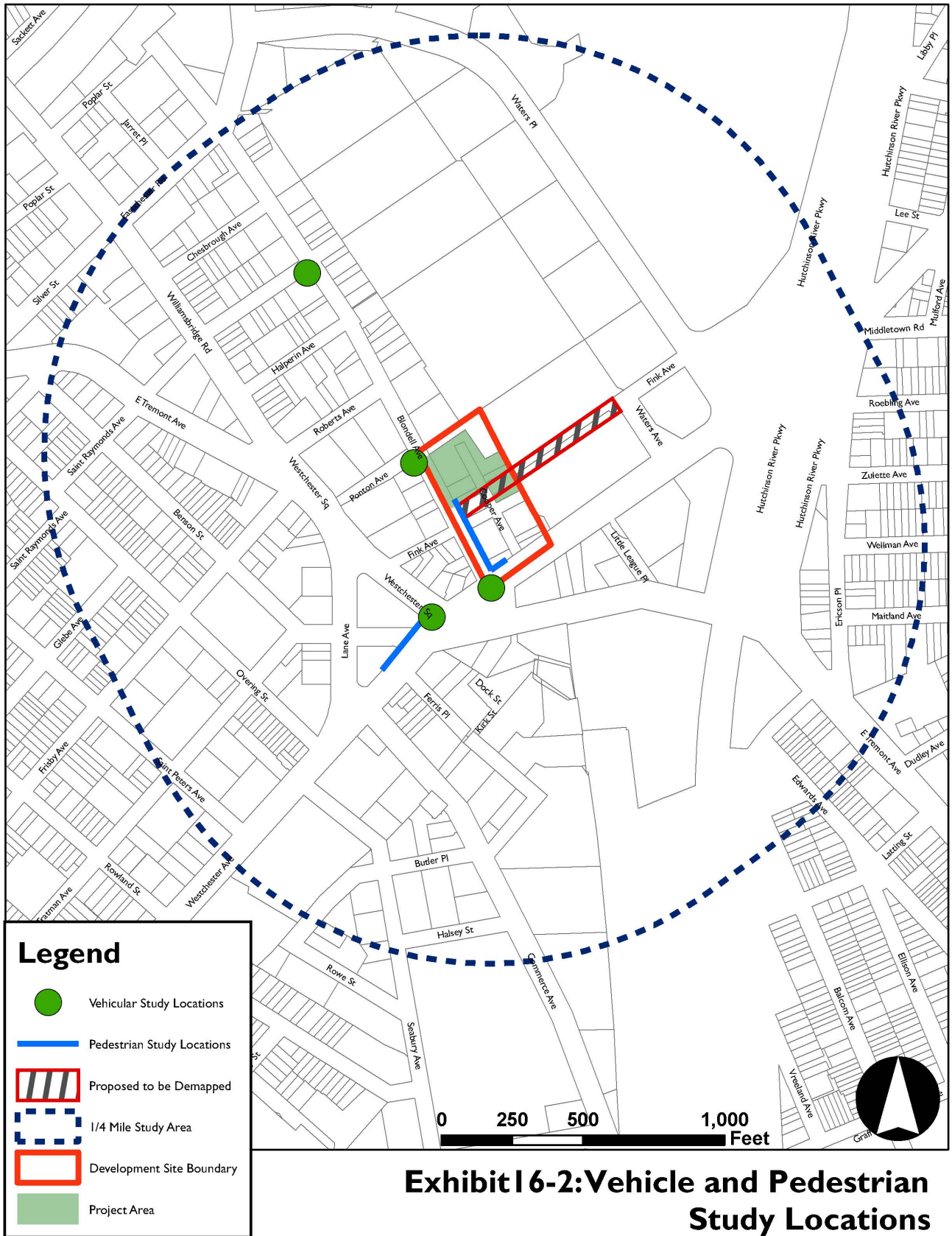

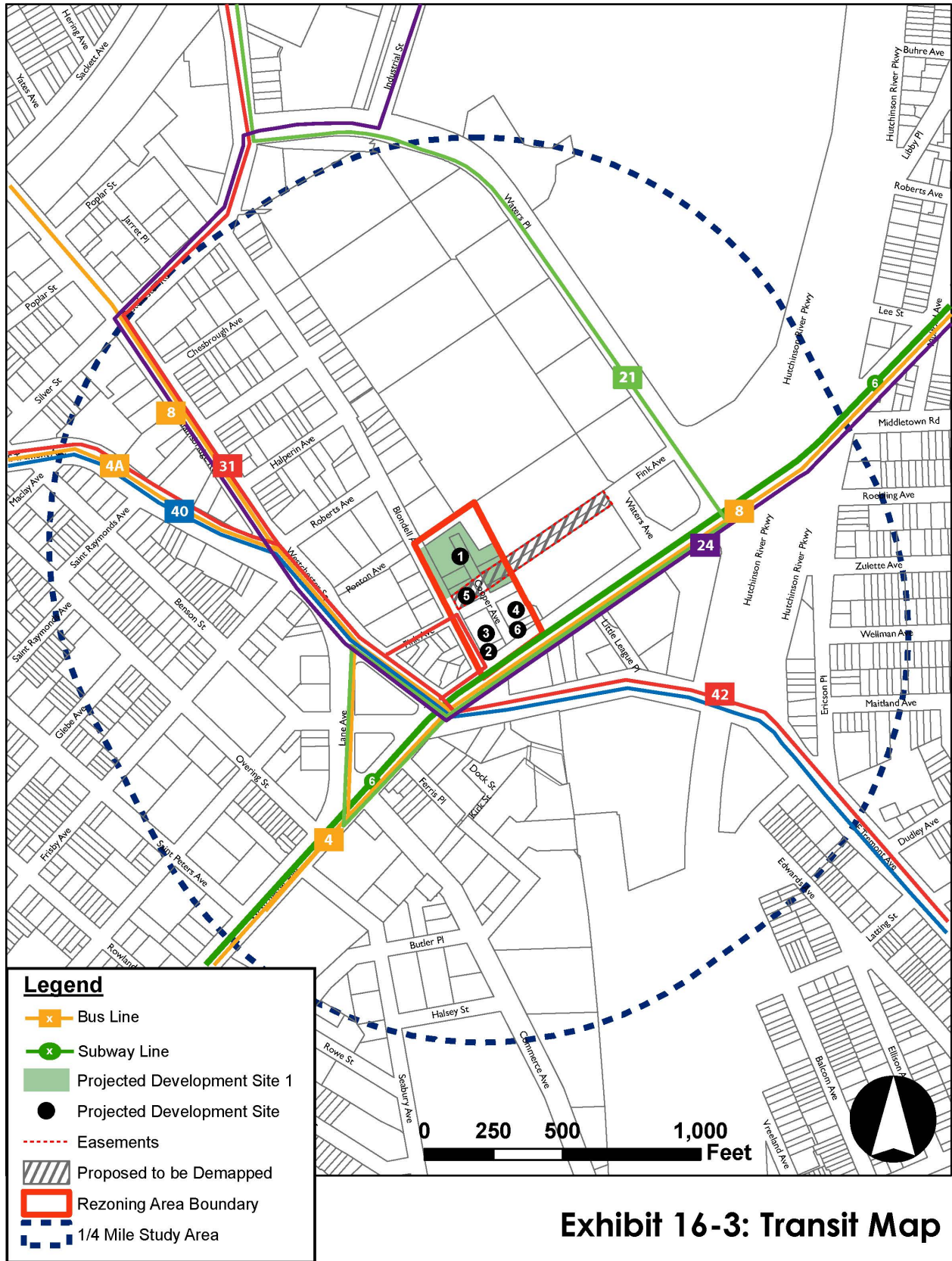

3. Trip Generation and Assignment

Analysis Periods

The trip generation and assignment estimates were prepared for four (4) peak hours: weekday morning, weekday midday, weekday evening, and Saturday midday.

Trip Generation

The following section describes the assumptions used to develop the trip generation and trip distribution characteristics of the Proposed Actions, which are described in greater detail in the Figure 16-1: Transportation Demand Factors (Appended Sheet A3). It is important to note that the travel demand factor assumptions contained herein have been previously reviewed and approved by the New York City Department of City Planning (DCP).

Residential

The residential component of the Project Area is proposed to consist of 380 net new residential dwelling units. The daily trip generation rates, temporal distribution, daily truck trip generation rates, and truck temporal distribution were obtained from the CEQR *Technical Manual*, Table 16-2. Modal split and vehicle occupancy were calculated based on the 2015 American Community Survey 5-year estimates for Census Tracts 200 and 284 in the Bronx. Directional distribution and truck directional distribution were obtained from the *Hunters Point South Rezoning and Related Actions FEIS (2008)*, Table 16-9, for the residential land use.

Local Retail

Approximately 9,025 gsf of net new local retail floor area is anticipated to be constructed with the Proposed Actions. The daily trip generation rates, temporal distribution, directional distribution, daily truck trip generation rates, and truck temporal distribution were obtained from the CEQR *Technical Manual*, Table 16-2. Modal split, vehicle occupancy, and truck directional distribution were obtained from the *Jerome Avenue Rezoning FEIS (2018)*, Table 13-8, for the local retail land use.

Community Facility

Approximately 2,024 gsf of net new community facility floor area is anticipated to be constructed with the Proposed Actions. Note that the proposed community facility space would be split between a medical office and day care center. The daily trip generation rates, temporal and directional distribution, daily truck trip generation rates, truck temporal and directional distribution, modal split, and vehicle occupancy were

obtained from the *Jerome Avenue Rezoning FEIS (2018)*, Table 13-8, for the community facility uses (medical office and day care center).

Linked Trips

Linked trips are pass-by trips or trips that have multiple destinations within the Project Area and are typical for multi-use sites. As the local retail use would be visited by patrons living or working within the Project Area, a 15% linked trip credit was applied to the total retail trips.

Trip Generation Results

The results of the trip generation estimates for the four (4) peak hours are summarized in appended Figure 16-2 (Appended Sheet A4) for the Proposed Actions. The summary results of the trip generation estimates for the Proposed Actions during the four (4) peak hours are summarized in Table 16-2.

Table 16-2: Proposed Action Modal Trip Generation Summary

Land Use	Weekday Morning Peak Hour			Weekday Midday Peak Hour			Weekday Evening Peak Hour			Saturday Midday Peak Hour		
	Enter	Exit	Total	Enter	Exit	Total	Enter	Exit	Total	Enter	Exit	Total
Vehicle (Auto/Taxi/Truck)	21	72	93	34	33	67	72	39	111	50	49	99
Subway	25	129	154	48	46	94	122	56	178	79	79	158
Bus	8	29	37	24	24	48	34	20	54	26	24	50
Walk	28	49	77	129	131	260	92	77	169	96	83	179

Trip Assignment

Trips were assigned to the study area according to existing traffic volumes, the location of residential properties, major arterial roadways in the surrounding area, other convenience-type uses, and the proposed access management plan.

The new vehicle trips generated by the Proposed Actions are summarized on Figures 16-3 through 16-6. The new pedestrian trips generated by the Proposed Actions are summarized on Figures 16-7 through 16-14.

It is important to note that the routing assumptions associated with the Proposed Actions total vehicle and pedestrian impact has been previously reviewed and preliminarily approved by the DCP.

4. Screening Assessment

Methodology

Transportation impact analysis methodologies for proposed projects in New York City are defined in the *2014 CEQR Technical Manual*, which outlines a two-tiered screening process. The Level 1 screening assessment uses the trip generation analysis to determine whether a project would result in at least 50 vehicle trips, 200 subway/rail or bus riders, or 200 pedestrian trips in a peak hour. If the trip generation numbers for the project are below these thresholds, then the project would not cause a significant adverse transportation impact, and no further analysis is needed. Conversely, if any threshold is reached or exceeded, then a Level 2 screening assessment must be performed for each travel mode and peak hour for which the Level 1 threshold is exceeded. The Level 2 screening assessment uses the trip assignments to determine whether a project would generate 50 or more vehicle trips through any intersection, 200 or more pedestrian trips along any pedestrian element, 50 or more bus trips in a single direction on a single route, or 200 passengers at a subway station or line during any peak hour. If these thresholds are not reached or exceeded at any location during any peak hour, no further analysis is needed to determine that the project would not have a significant adverse transportation impact. If any Level 2 threshold is reached or exceeded, the project would require detailed analyses. The results of the screening analysis are described below.

Traffic

According to the criteria specified in the *2014 CEQR Technical Manual*, a Level 2 traffic analysis is required if at least 50 new vehicle trips would be generated by a proposed action during an individual peak hour. As shown in Table 16-2, the vehicular traffic volumes generated by the Proposed Actions would generate more than 50 vehicle trips during the study periods.

Based on criteria specified in the *2014 CEQR Technical Manual*, detailed analyses are required if an action would result in at least 50 additional vehicle trips at any intersection during any peak hour. The vehicular volumes generated by the Proposed Actions would exceed the 50-vehicle trip threshold at the following intersections during the peak hours indicted.

- Unsignalized intersection of Blondell Avenue and Ponton Avenue (AM, PM, SAT);
- Unsignalized intersection of Blondell Avenue and Saint Raymond Avenue (AM);
- Signalized intersection of Blondell Avenue and Westchester Avenue (PM, SAT); and

- Signalized intersection of Westchester Avenue and East Tremont Avenue (PM).

Therefore, an operational analysis of traffic conditions in the future with the Proposed Actions was performed. It is important to note that the scope of vehicular study intersections associated with the Proposed Actions has been previously reviewed and preliminarily approved by the DCP.

Transit

Subway Transit

According to the criteria specified in the *2014 CEQR Technical Manual* and used by MTA/NYCT, a Level 2 subway analysis should be performed if a proposed action would generate at least 200 new subway trips during a peak hour. As shown on Table 16-2, the volume of new subway trips generated by the Proposed Actions would not reach the 200-passenger threshold during any of the peak hours; therefore, analyses of subway lines and subway station elements were not conducted.

Bus Transit

According to the criteria specified in the *2014 CEQR Technical Manual* and used by MTA/NYCT, a Level 2 bus analysis should be performed if a proposed action would generate at least 200 new bus trips during a peak hour. As shown on Tables 16-2, the volume of new bus trips generated by the Proposed Actions would not reach this threshold during any of the peak hours; therefore, analyses of bus routes were not conducted.

Pedestrians

Based on criteria specified in the *2014 CEQR Technical Manual*, a Level 2 pedestrian analysis should be performed if an action would generate at least 200 new pedestrian trips during a peak hour. Table 16-2 shows that the Proposed Actions would generate more than 200 total new pedestrian trips during the study periods.

Based on criteria specified in the *2014 CEQR Technical Manual*, detailed analyses are required if an action would result in at least 200 additional pedestrians at any sidewalk, crosswalk, or intersection corner during any peak hour. The pedestrian volumes generated by the Proposed Actions would exceed the 200-person threshold at the following pedestrian elements during the peak hours indicted.

- Sidewalk along the easterly side of Blondell Avenue between Fink Avenue and Ponton Avenue (MID, PM, SAT).
- Crosswalk across Fink Avenue on the easterly side of Blondell Avenue (MID,

PM).

- Northeast corner of the intersection of Blondell Avenue and Fink Avenue (MID, PM, SAT).
- Sidewalk along the easterly side of Blondell Avenue between Fink Avenue and Westchester Avenue (MID).
- Northeast corner of the intersection of Blondell Avenue and Westchester Avenue (MID, PM, SAT).
- Sidewalk along the northerly side of Westchester Avenue between East Tremont Avenue and the entrance to the NYCT/MTA No. 6 Subway train (PM, SAT).

Therefore, an operational analysis of pedestrian conditions in the future with the Proposed Actions was performed. It is important to note that the scope of pedestrian study elements associated with the Proposed Actions has been previously reviewed and preliminarily approved by the DCP.

5. Operational Analysis Methodology

This section summarizes the operational analysis methodologies and significant impact criteria in accordance with the *2014 CEQR Technical Manual* guidelines for traffic, pedestrians, parking, and safety.

Traffic Operations

The operations of the vehicular study area elements were analyzed in accordance with the *2014 CEQR Technical Manual* guidelines by applying the methodologies presented in the *2000 Highway Capacity Manual* (HCM 2000) using Synchro 10 Software. A description of these methodologies is provided below.

The Level of Service (LOS) of a vehicular intersection is defined in terms of control delay (seconds/vehicle). Several factors contribute to vehicular Level of Service including traffic volumes, lane widths, percentage of heavy vehicles, frequency of bus and on-street parking maneuvers, and peak-hour factor. LOS A indicates operations with delay of less than 10 seconds per vehicle, while LOS F describes operations with delay in excess of 50 seconds per vehicle. For a signalized intersection, LOS A indicates operations with delay of less than 10 seconds per vehicle, while LOS F describes operations with delay in excess of 80 seconds per vehicle. The LOS criteria for intersection analysis, as defined in the *2014 CEQR Technical Manual*, are provided in Table 16-3.

Table 16-3: LOS Criteria for Intersection Analysis

Level of Service (LOS) Average Delay

	Signalized (sec/veh)	Unsignalized (sec/veh)
A	≤ 10	≤ 10
B	> 10 - 20	> 10 - 15
C	> 20 - 35	> 15 - 25
D	> 35 - 55	> 25 - 35
E	> 55 - 80	> 35 - 50
F	> 80	> 50

Pedestrian Operations

The operations of the pedestrian study area elements were analyzed in accordance with the *2014 CEQR Technical Manual* guidelines by applying the methodologies presented in the *2010 Highway Capacity Manual* (HCM 2010) using the Pedestrian LOS Worksheet. A description of these methodologies is provided below.

Pedestrian Elements

The Level of Service (LOS) of a pedestrian element is defined in terms of pedestrian space, expressed as square feet per pedestrian (ft²/p). Pedestrian Level of Service is an indicator of the quality of pedestrian movement and comfort. Several factors contribute to pedestrian Level of Service including effective sidewalk or crosswalk width, pedestrian crossing times, general flow of pedestrians (“platooning” or “non-platooning”), and peak-hour factor. Platoon flow occurs when 15-minute intervals of pedestrian volumes fluctuate over the course of an hour. This commonly occurs near a bus stop or subway station when an influx of pedestrians is introduced at a single instance. For platoon flow pedestrian elements, LOS A describes operations with minimal delays or discomfort, 530 square feet per pedestrian or more, while LOS F describes operations with 11 square feet or less per pedestrian. The LOS criteria for pedestrian elements, as defined in the *2014 CEQR Technical Manual*, are provided in Table 16-4.

Table 16-4: LOS Criteria for Pedestrian Elements

Level of Service (LOS) Average Delay

	Non-Platoon Flow	Platoon Flow	Corner/Crosswalk
A	> 60 ft ² /p	> 530 ft ² /p	> 60 ft ² /p
B	> 40 - 60 ft ² /p	> 90 - 530 ft ² /p	> 40 - 60 ft ² /p
C	> 24 - 40 ft ² /p	> 40 - 90 ft ² /p	> 24 - 40 ft ² /p
D	> 15 - 24 ft ² /p	> 23 - 40 ft ² /p	> 15 - 24 ft ² /p
E	> 8 - 15 ft ² /p	> 11 - 23 ft ² /p	> 8 - 15 ft ² /p
F	≤ 8 ft ² /p	≤ 11 ft ² /p	≤ 8 ft ² /p

6. Existing Conditions (2018)

Traffic

In accordance with CEQR standards, the existing vehicular study intersection volumes were based on data collected in November 2014 when local schools were in session, during peak periods when background traffic and pedestrian activity are typically greatest and/or when the proposed project is projected to introduce the greatest number of pedestrian trips to the adjacent network. The field program included manual counts of vehicles conducted on Wednesday, November 8, 2014 and Saturday, November 12, 2018. The representative peak hours of background traffic in the study area were determined to be:

- Weekday morning: 7:45 AM – 8:45 AM
- Weekday midday: 12:00 PM – 1:00 PM
- Weekday evening: 4:30 PM – 5:30 PM
- Saturday midday: 12:00 PM – 1:00 PM

Note that the 2014 count data was grown to the present day (2018) utilizing the appropriate growth factor published in the CEQR *Technical Manual* which is described further herein. The 2018 Existing Condition traffic volumes are provided on Figures 16-15 through 16-18.

An inventory of the study intersections was performed to determine traffic signal timing, phasing, and cycle length; street and curbside signage; pavement markings; and lane dimensions to be used in the calculation of street capacities. Also, official signal timing data were obtained from NYCDOT to confirm field observations and for incorporation into the capacity analysis. The 2014 existing count data, condition diagrams, and NYCDOT signal timing information is provided in the technical appendix.

Under the 2018 Existing Condition, a Level of Service/Capacity Analysis was conducted for the study intersections. Tables 16-5 through 16-11 summarizes the 2018 Existing Conditions Level of Service for the study peak hours. All movements at the study intersections are calculated to operate at an acceptable Level of Service C or better during the study peak hours.

Pedestrians

In accordance with CEQR standards, the existing pedestrian study element volumes were based on data collected in September 2018 when local schools were in session, during peak periods when background traffic and pedestrian activity are typically greatest and/or when the proposed project is projected to introduce the greatest number of pedestrian trips to the adjacent network. The field program included manual counts of pedestrians conducted on three weekdays (Thursday, September 20, 2018, Tuesday, September 25, 2018, and Tuesday, October 9, 2018) and two Saturdays (September 15, 2018 and September 22, 2018). The representative peak hours of background traffic in the study area were determined to be:

- Weekday morning: 7:45 AM - 8:45 AM (10/9)
- Weekday midday: 12:30 PM - 1:30 PM (9/20) & 12:15 PM - 1:15 PM (9/25)
- Weekday evening: 4:00 PM - 5:00 PM (9/20 & 9/25)
- Saturday midday: 12:30 PM - 1:30 PM (9/15) & 1:00 PM - 2:00 PM (9/22)

The 2018 Existing Condition pedestrian volumes are provided on Figures 16-19 through 16-22. Under the 2018 Existing Condition, a Level of Service/Capacity Analysis was conducted for the study pedestrian elements. Tables 16-12 through 16-20 summarize the 2018 Existing Conditions Level of Service for the study peak hours. All pedestrian elements are calculated to operate at an acceptable Level of Service A during the study peak hours.

It is important to note that the northeast corner of Blondell Avenue and Fink Avenue and the crosswalk across Fink Avenue on the easterly side of Blondell Avenue was requested to be analyzed in terms of the impact to pedestrians; however, the intersection of Blondell Avenue and Fink Avenue is unsignalized. Therefore, corner and crosswalk pedestrian analysis is not applicable and the sidewalk element along the easterly side of Blondell Avenue between Fink Avenue and Ponton Avenue is representative of pedestrian operating conditions.

7. Future Conditions without the Proposed Actions (2029)

Traffic & Pedestrians

The 2029 No-Action Condition builds on the 2018 Existing Condition analysis by incorporating background growth, other nearby projects expected to be completed by the project analysis year (the “Build Year,” which is 2029), and anticipated changes in the transportation network. The No-Action Condition serves as the baseline with which the future condition with the Proposed Actions will be compared to identify potential impacts.

2014 CEQR Technical Manual Table 16-4 provides an annual background growth rate for the subject area of the Bronx of 0.25 percent for the first five (5) years and 0.125 percent for the years beyond. The annual growth rates were applied, over a period of eleven (11) years, to the 2018 Existing Condition vehicular and pedestrian volumes to develop the 2029 No-Action Condition vehicular and pedestrian volumes. The 2029 No-Action Condition vehicular volumes are summarized on Figures 16-23 through 16-26. The 2029 No-Action Condition pedestrian volumes are provided on Figures 16-27 through 16-30.

Under the 2029 No-Action Condition, a Level of Service/Capacity Analysis was conducted for the study vehicular intersections and pedestrian elements. As shown in tables 16-5 through 16-20, all of the vehicular study intersections and pedestrian study elements are calculated to continue to operate generally consistently with the findings of the 2018 Existing Condition during the study peak hours.

8. Future Conditions with the Proposed Actions (2029)

Traffic

The new traffic volumes associated with the Proposed Actions were added to the 2029 No-Action traffic volumes to calculate the 2029 With-Action traffic volumes, which are shown in Figures 16-31 through 16-34.

Tables 16-5 through 16-11 summarize the vehicular analysis level of service results under 2029 With-Action Conditions and compares the results of the 2018 Existing Conditions and 2029 No-Action Conditions for the vehicular intersections that were studied. Under the 2029 With-Action Condition, the vehicular study intersections are calculated to operate generally consistently with the findings of the 2029 No-Action Condition.

According to the guidance in the *2014 CEQR Technical Manual*, a significant adverse impact on a signalized intersection would not occur if acceptable levels of service (mid-LOS D or better) would prevail under With-Action conditions. With the Proposed Actions in place in 2029, the vehicular study intersections would operate at acceptable LOS C or better during the study peak hours. The proposed actions would therefore not have a significant adverse impact on vehicular flow.

- **BLONDELL AVENUE AND PONTON AVENUE**

NB (Northbound) approach is the Blondell Avenue approach

EB (Eastbound) approach is the Ponton Avenue approach

X (n) = Level of Service (seconds of delay)

Table 16-5 - Weekday Morning Peak Hour

Lane Group	2018 Existing	2029 No Action	2029 With Action
EB Left/Through	B (13.0)	B (13.2)	C (15.4)
WB Right	--	--	B (11.5)

Table 16-6 – Weekday Evening Peak Hour

Lane Group	2018 Existing	2029 No Action	2029 With Action
EB Left/Through	B (12.3)	B (12.4)	B (13.9)
WB Right	--	--	B (10.8)

Table 16-7 – Saturday Midday Peak Hour

Lane Group	2018 Existing	2029 No Action	2029 With Action
EB Left/Through	B (11.0)	B (11.1)	B (12.1)
WB Right	--	--	A (9.9)

• **BLONDELL AVENUE AND SAINT RAYMOND AVENUE**

NB (Northbound) approach is the Blondell Avenue approach

EB (Eastbound) approach is the Saint Raymond Avenue approach

X (n) = Level of Service (seconds of delay)

Table 16-8 – Weekday Morning Peak Hour

Lane Group	2018 Existing	2029 No Action	2029 With Action
EB Left/Through	B (12.8)	B (13.0)	B (14.7)
NB Through/Left	A (0.8)	A (0.8)	A (1.6)

- **WESTCHESTER AVENUE AND BLONDELL AVENUE**

NB (Northbound) and SB (Southbound) approaches are the Blondell Avenue approach

EB (Eastbound) and WB (Westbound) approaches are the Westchester Avenue approach

X (n) = Level of Service (seconds of delay)

Table 16-9 - Weekday Evening Peak Hour

Lane Group	2018 Existing	2029 No Action	2029 With Action
EB Left/Through	B (10.1)	B (10.1)	B (10.2)
WB Through/Right	B (19.0)	B (19.2)	B (19.3)
NB Left	C (21.3)	C (21.4)	C (21.4)
NB Through	C (22.0)	C (22.1)	C (22.7)
NB Right	C (20.6)	C (20.6)	C (20.7)
Intersection	B (16.4)	B (16.5)	B (16.8)

Table 16-10 - Saturday Midday Peak Hour

Lane Group	2018 Existing	2029 No Action	2029 With Action
EB Left/Through	B (14.3)	B (14.5)	B (14.7)
WB Through/Right	B (14.1)	B (14.2)	B (14.3)
NB Left	B (17.6)	B (17.7)	B (17.7)
NB Through	B (18.0)	B (18.1)	B (18.5)
NB Right	B (16.8)	B (16.8)	B (16.9)
Intersection	B (15.2)	B (15.3)	B (15.5)

- WESTCHESTER AVENUE AND EAST TREMONT AVENUE/WESTCHESTER SQUARE**

EB (Eastbound) and WB (Westbound) approaches are the Westchester Avenue approach

NB (Northbound) approach is the E Tremont Avenue approach

SB (Southbound) approach is the Westchester Square approach

X (n) = Level of Service (seconds of delay)

Table 16-11 – Weekday Evening Peak Hour

Lane Group	2018 Existing	2029 No Action	2029 With Action
EB Through	C (23.9)	C (24.3)	C (24.7)
EB Right	B (17.8)	B (17.9)	B (17.9)
WB Through/Right	A (8.5)	A (8.6)	A (8.8)
NB Through	C (24.9)	C (25.0)	C (25.0)
SB Left/Through/Right	C (31.0)	C (31.6)	C (32.8)
Intersection	B (19.5)	C (19.8)	C (20.4)

Pedestrian

The Proposed Actions-generated pedestrian volumes were added to the 2029 No-Action pedestrian volumes to calculate the 2029 With-Action Pedestrian Volumes, which are shown in Figures 16-35 to 16-38.

Tables 16-12 through 16-20 summarize the pedestrian analysis level of service results under 2029 With-Action Conditions and compares the results of the 2018 Existing Conditions and 2029 No-Action Conditions for the pedestrian elements that were studied. Under the 2029 With-Action Condition, the pedestrian study elements are calculated to operate generally consistently with the findings of the 2029 No-Action Condition.

According to the guidance in the 2014 *CEQR Technical Manual*, a significant adverse pedestrian impact would not occur if acceptable levels of service (LOS C or better) would prevail under With-Action conditions. With the Proposed Actions in place, the study pedestrian elements would operate at acceptable LOS B or better during the two peak hours that were studied. The proposed actions would therefore not have a significant adverse impact on pedestrian movement.

Table 16-12: CEQR Pedestrian Analysis - East Sidewalk along Blondell Avenue between Fink Avenue and Westchester Avenue

Analysis Period	Sidewalk Dimensions		Pedestrian Volumes		Average Pedestrian Space (ft ² /p)	Platoon Adjusted Level of Service
	Total Width (ft)	Effective Width (ft)	Weekday Midday		Weekday Midday	Weekday Midday
			NB	SB		
2018 Existing Condition	12.8	6.6	2	5	9547.2	A
2029 No-Action Condition	12.8	6.6	2	5	9552.0	A
2029 With-Action Condition	12.8	11.3	110	108	524.0	B

Table 16-13: CEQR Pedestrian Analysis - NE Corner of Blondell Avenue and Westchester Avenue

Analysis Period	Corner Dimensions		Pedestrian Volumes (rounding corner)	Corner Circulation Area Pedestrian Space (ft ² /p)	Level of Service
	Radius (ft)	Obstructions (ft ²)	Weekday Midday	Weekday Midday	Weekday Midday
2018 Existing Condition	12.0	7.0	7	1861.4	A
2029 No-Action Condition	12.0	7.0	7	1805.6	A
2029 With-Action Condition	12.0	7.0	58	404.5	A

Table 16-14: CEQR Pedestrian Analysis - NE Corner of Blondell Avenue and Westchester Avenue

Analysis Period	Corner Dimensions		Pedestrian Volumes (rounding corner)	Corner Circulation Area Pedestrian Space (ft ² /p)	Level of Service
	Radius (ft)	Obstructions (ft ²)	Weekday Evening	Weekday Evening	Weekday Evening
2018 Existing Condition	12.0	7.0	6	1726.9	A
2029 No-Action Condition	12.0	7.0	6	1670.1	A
2029 With-Action Condition	12.0	7.0	38	358.2	A

Table 16-15: CEQR Pedestrian Analysis - NE Corner of Blondell Avenue and Westchester Avenue

Analysis Period	Corner Dimensions		Pedestrian Volumes (rounding corner)	Corner Circulation Area Pedestrian Space (ft ² /p)	Level of Service
	Radius (ft)	Obstructions (ft ²)	Saturday Midday	Saturday Midday	Saturday Midday
2018 Existing Condition	12.0	7.0	5	2874.3	A
2029 No-Action Condition	12.0	7.0	5	2866.2	A
2029 With-Action Condition	12.0	7.0	40	430.0	A

Table 16-16: CEQR Pedestrian Analysis – East Sidewalk along Blondell Avenue between Fink Avenue and Ponton Avenue

Analysis Period	Sidewalk Dimensions		Pedestrian Volumes		Average Pedestrian Space (ft ² /p)	Platoon Adjusted Level of Service
	Total Width (ft)	Effective Width (ft)	Weekday Midday		Weekday Midday	Weekday Midday
			NB	SB		
2018 Existing Condition	12.8	6.6	3	2	13366.1	A
2029 No-Action Condition	12.8	6.6	3	2	13366.1	A
2029 With-Action Condition	11	4.5	117	113	197.0	B

Table 16-17: CEQR Pedestrian Analysis – East Sidewalk along Blondell Avenue between Fink Avenue and Ponton Avenue

Analysis Period	Sidewalk Dimensions		Pedestrian Volumes		Average Pedestrian Space (ft ² /p)	Platoon Adjusted Level of Service
	Total Width (ft)	Effective Width (ft)	Weekday Evening		Weekday Evening	Weekday Evening
			NB	SB		
2018 Existing Condition	12.8	6.6	3	7	6683.0	A
2029 No-Action Condition	12.8	6.6	3	7	6683.0	A
2029 With-Action Condition	11	4.5	152	102	178.4	B

Table 16-18: CEQR Pedestrian Analysis – East Sidewalk along Blondell Avenue between Fink Avenue and Ponton Avenue

Analysis Period	Sidewalk Dimensions		Pedestrian Volumes		Average Pedestrian Space (ft ² /p)	Platoon Adjusted Level of Service
	Total Width (ft)	Effective Width (ft)	Saturday Midday		Saturday Midday	Saturday Midday
			NB	SB		
2018 Existing Condition	12.8	6.6	4	2	11138.4	A
2029 No-Action Condition	12.8	6.6	4	2	11138.4	A
2029 With-Action Condition	11	4.5	119	117	192.0	B

Table 16-19: CEQR Pedestrian Analysis – North Sidewalk along Westchester Avenue between Lane Avenue and Westchester Square

Analysis Period	Sidewalk Dimensions		Pedestrian Volumes		Average Pedestrian Space (ft ² /p)	Platoon Adjusted Level of Service
	Total Width (ft)	Effective Width (ft)	Weekday Evening		Weekday Evening	Weekday Evening
			EB	WB		
2018 Existing Condition	20.5	11.9	304	368	149.3	B
2029 No-Action Condition	20.5	11.9	316	382	143.7	B
2029 With-Action Condition	20.5	11.9	458	455	109.7	B

Table 16-20: CEQR Pedestrian Analysis – North Sidewalk along Westchester Avenue between Lane Avenue and Westchester Square

Analysis Period	Sidewalk Dimensions		Pedestrian Volumes		Average Pedestrian Space (ft ² /p)	Platoon Adjusted Level of Service
	Total Width (ft)	Effective Width (ft)	Saturday		Saturday	Saturday
			EB	WB		
2018 Existing Condition	20.5	11.9	195	172	285.9	B
2029 No-Action Condition	20.5	11.9	202	179	275.4	B
2029 With-Action Condition	20.5	11.9	300	274	182.7	B

9. Parking Supply and Utilization

As shown in Table 16-1, a total of 265 parking stalls would be developed as part of the Proposed Actions. Parking would be provided in three (3) facilities: 225 parking stalls would be developed on the applicant-owned site; 19 parking stalls would be developed on soft site #3; and 21 parking stalls would be developed on soft site #4. Access to the applicant-owned parking garage would be provided along Blondell Avenue and access to the soft-site parking would be provided via Cooper Avenue. Note that off-street parking is not required for the soft sites.

A parking accumulation for the residential portion of the applicant-owned development site was developed based on vehicle ownership data from the 2010 US Census Data. As shown in table 16-21, the residential component of the applicant-owned development site is anticipated to generate a maximum parking demand of 172 which would be fully accommodated in the 225 parking stalls in the applicant-owned parking garage. Therefore, the Proposed Actions would not result in a significant adverse impact on parking operations in the study area.

Table 16-21: Parking Accumulation

	Weekday			Saturday		
	In	Out	Demand	In	Out	Demand
Midnight - 1 AM	4	4	172	1	1	171
1 AM - 2 AM	2	2	172	1	1	171
2 AM - 3 AM	1	1	172	0	0	171
3 AM - 4 AM	1	1	172	0	0	171
4 AM - 5 AM	1	1	172	0	0	171
5 AM - 6 AM	1	1	172	3	3	171
6 AM - 7 AM	1	1	172	1	4	168
7 AM - 8 AM	2	16	158	4	13	159
8 AM - 9 AM	6	34	130	5	16	148
9 AM - 10 AM	6	24	112	7	20	135
10 AM - 11 AM	6	17	101	8	24	119
11 AM - Noon	8	12	97	9	25	103
Noon - 1 PM	11	11	97	11	32	82
1 PM - 2 PM	10	10	97	19	19	82
2 PM - 3 PM	9	9	97	23	16	89
3 PM - 4 PM	12	12	97	23	15	97
4 PM - 5 PM	19	13	103	22	15	104
5 PM - 6 PM	33	14	122	22	15	111
6 PM - 7 PM	27	15	134	24	13	122
7 PM - 8 PM	26	11	149	28	9	141
8 PM - 9 PM	11	5	155	24	8	157
9 PM - 10 PM	9	4	160	20	7	170

10 PM - 11 PM	10	4	166	9	7	172
11 PM - Midnight	7	3	170	3	3	172
Total Vehicle Trips	223	225	--	267	266	--

10. Assessment of Vehicular and Pedestrian Safety Issues

An assessment of vehicular and pedestrian safety issues is performed in conjunction with a detailed vehicle and pedestrian analysis because increased vehicular activity and pedestrian crossings at documented high-accident locations may result in increasingly unsafe conditions.

Crash data for the study area intersections were obtained from NYCDOT for the three (3)-year time period between January 1, 2013 and December 31, 2015 and quantify the total number of reportable crashes (involving fatality, injury, or more than \$1,000 in property damage), fatalities, and injuries during the study period, as well as a yearly breakdown of pedestrian- and bicycle-related crashes at each location. Please note that crash data at the study intersection for 2016 was not included in this analysis as complete data could not be provided by the NYCDOT. According to the *2014 CEQR Technical Manual*, a high-crash location is an intersection with more than 48 total reportable and non-reportable crashes or five (5) or more pedestrian/bicycle injury crashes during any consecutive 12 months of the most recent three (3)-year period for which data is available. Table 16-22 depicts total crashes at the subject intersection during the three (3)-year period, as well as a breakdown of pedestrian and bicycle crashes by year and location.

Table 16-22: Crash Data Summary

Intersection	Total Crashes			Pedestrian			Bicycle			Combined Ped/Bike		
	2013	2014	2015	2013	2014	2015	2013	2014	2015	2013	2014	2015
East Tremont Avenue & Westchester Avenue	12	6	7	3	0	3	1	1	0	4	1	3
Westchester Avenue & Blondell Avenue	2	6	3	0	0	0	0	0	0	0	0	0
Blondell Avenue & Ponton Avenue	0	0	0	0	0	0	0	0	0	0	0	0
Blondell Avenue & Saint Raymond's Avenue	0	0	2	0	0	0	0	0	0	0	0	0

Based on the crash data, none of the study intersections would be classified as high-crash locations per the *2014 CEQR Technical Manual*. The increased vehicular and pedestrian volumes resulting from the proposed action would therefore not have a significant adverse impact on vehicular and pedestrian safety.

11. Conclusion

The proposed actions would not have a significant adverse impact on traffic flow, transit operations, pedestrian movement, or vehicular and pedestrian safety.

17. AIR QUALITY

Introduction

Ambient air quality describes pollutant levels in the surrounding environment to which the public has access. To assess potential health hazards due to ambient air quality, air pollutants produced by motor vehicles (mobile source) and by fixed facilities (stationary source) are analyzed. Under the *New York City Environmental Quality Review 2014 Technical Manual (CEQR TM)*, the effects of both the proposed project on ambient air quality and the ambient air quality effect on the proposed project are analyzed.

The Affected Area comprises of nine lots in the Van Nest-Morris Park-Westchester Square neighborhood of the Bronx. The Area is bounded by Blondell Avenue to the west, Westchester Avenue to the south, MTA's Pelham Maintenance tracks to the north and east, and Ponton Avenue to the north. Under the proposed rezoning action, the Affected Area would be redeveloped with six mixed-use, primarily residential, buildings. **Table 17-1** shows the Projected Developments Sites, where Projected Development Site 1, located at the east corner of Blondell Avenue and Ponton Avenue, is the Applicant Site.

Table 17-1. Projected Developments Description.

Site ID	Block	Lot	Projected Development Land Use
1	4134	1 (formerly Block 4134 Lots 1, 2, 4, 62,63,70, and Block 4133, Lot 12)	Residential, commercial retail, community facility, parking (225 spaces)
2	4133	1	Residential, commercial
3	4133	2	Residential, commercial, parking (19 spaces)
4	4133	63	Residential, commercial, parking (21 spaces)
5	4133	10	Residential, commercial
6	4133	61, 62	Residential, commercial

The potential air quality impacts of the following emissions were estimated following the procedures and methodologies prescribed in the *CEQR TM*:

- The potential for changes in vehicular travel associated with proposed development activities to result in significant mobile source (vehicular related) air quality impacts.
- The potential for emissions from the heating, ventilation and air conditioning (HVAC) systems of the proposed development to significantly impact nearby existing or planned land uses.
- The potential for air toxic emissions released from existing industrial facilities to significantly impact the proposed development.

- The potential for significant air quality impacts from the emissions of facilities that require Prevention of Significant Deterioration permits (Title V), and facilities which require a state facility permit to significantly impact the proposed development.
- The potential for facilities' malodorous emissions to unreasonably interfere with the proposed project's occupant's comfortable enjoyment of life or their property.

Principal Conclusion

Screening analysis for carbon monoxide was carried out to determine whether the project-generated traffic has the potential to cause significant air quality impacts. The preliminary traffic analysis for the Proposed Project indicated that the expected maximum peak hour increment is below the *CEQR Technical Manual* threshold of concern of 170 vehicle trips during any peak hour. Therefore, no significant air quality impacts are expected as a result of the Proposed Actions.

Screening analysis for particulate matter was carried out to determine whether the project-generated traffic has the potential to cause significant air quality impacts. The traffic analysis for the Proposed Project and county data for the Bronx indicated that the expected maximum peak hour increment failed the *CEQR TM* threshold of equivalent truck trips during the PM peak hour period. Therefore, a detailed analysis using MOVES and AERMOD was conducted. No significant air quality impacts were expected as a result of the Proposed Actions.

A screening analysis for the parking garages showed that Projected Development Site 1 requires a detailed analysis and Projected Development Sites 3 and 4 pass the screening analysis. No parking garage screening analyses would be required for Projected Development Sites 2, 5, and 6 as development projected on these Sites would not contain any parking or parking garages. Air quality impacts for Projected Development Site 1 were analyzed following the *CEQR TM* methodology. Pollutants from vehicle emissions were generated by the EPA's mobile source emission factor model, MOVES2014a. Pollutants concentrations from the garage's exhaust vent and from the on-street traffic emissions were calculated using the spreadsheet and formula referenced in the *CEQR TM Appendices*. No significant air quality impacts were predicted.

The Projected Development Sites impacts associated with the boiler stack emissions (HVAC) on existing land uses screened out. Detailed analyses using AERMOD modeling were conducted for the project-on-project impact. The HVAC analysis concluded that fuel would need to be restricted to the exclusive use of natural gas in all the HVAC systems of the projected buildings and the minimum stack heights would need to be specified for all the Projected Development Sites. In addition, all the

Projected Development Sites, excluding Projected Development Site 1, required specifying the stacks' locations due to the buildings' setback distances.

The land survey study identified the uses at 36 sites. Two operational permits were acquired through the NYCDEP Clean Air Tracking System database; one for a gas station and the other for an auto body spray booth. Three additional auto body spray booth operations were identified in the field survey and online searches. Gas stations are not analyzed under CEQR and the spray booth facilities were analyzed as a cumulative impact. Air quality impacts were predicted at some locations. Operable windows and/or air intakes were restricted at these locations. In addition, no major sources or odor producing facilities were identified within 1,000 feet of the Affected Area.

Air Pollutants and Applicable Standards/Guidelines

National Air Quality Standards

The U.S. Environmental Protection Agency (EPA) has identified six pollutants, known as criteria pollutants which are being of concern nationwide, and established threshold concentration based upon adverse effect on human health. The six pollutants and their characteristics are:

- Carbon Monoxide (CO) is mainly produced by motor vehicles from the incomplete combustion of gasoline. The impact of CO on the ambient air is analyzed next to roadways, intersections, parking lots, and parking garages vents as these locations are the most affected.
- Nitrogen Dioxide (NO₂) is a main concern related to the burning of natural gas. Emitted NO_x from the burning of fossil fuel gradually convert to NO₂ in a chemical reaction that is affected by ozone concentration and the presence of sunlight. In a micro scale analysis, buildings HVAC systems are analyzed for NO₂ impact.
- Ozone (O₃) is formed by chemical reaction between hydrocarbons and nitrogen oxides and its impact is analyzed on a regional scale by monitoring stations.
- Lead (Pb) in the ambient air is monitored on a regional level. In a project scale analysis, impact due to Lead concentration levels are analyzed if a new source, such as lead smelters, is introduced into the environment or if a project is located next to a lead emitter.
- Particulate Matter emissions are associated with both stationary sources and mobile sources. Two sizes of particulate matters are analyzed: Inhalable Particles (PM₁₀) and Fine Particulate Matter (PM_{2.5}), where the subscript number refers to the diameter of the particulate matter in micrometers.

- Sulfur Dioxide (SO₂) emission is principally associated with stationary sources that burn oil or coal. These fuels contain sulfur that bond to oxygen atoms in the burning process.

As required by the Clean Air Act, National Ambient Air Quality Standards (NAAQS) have been established for the criteria pollutants by EPA, and New York State has adopted the NAAQS as the State ambient air quality standards. The NO₂, CO, PM_{2.5}, and PM₁₀ standards—the pollutant of main concern for this Proposed Actions— together with their health-related averaging periods are presented in **Table 17-2**.

Table 17-2. National and New York States Ambient Air Quality.

Pollutant	Averaging Period	National and State Standards
NO ₂	1-Hour Concentration	0.10 ppm (188 µg/m ³)
	Annual Arithmetic Average	0.053 ppm (100 µg/m ³)
PM _{2.5}	24-Hour Concentration	35 µg/m ³
	Average of 3 Consecutive Annual Means	12 µg/m ³
PM ₁₀	24-Hour Concentration	150 µg/m ³
CO	8-Hour	9 ppm
	1-Hour	35 ppm

NO₂ NAAQS

Nitrogen oxide (NO_x) emissions from gas combustion consist predominantly of nitric oxide (NO) at the source. The NO_x in these emissions are then gradually converted to NO₂, which is the pollutant of concern, in the atmosphere (in the presence of ozone and sunlight as these emissions travel downwind of a source).

The 1-hour NO₂ NAAQS standard of 0.100 ppm (188 ug/m³) is the 3-year average of the 98th percentile of daily maximum 1-hour average concentrations in a year. For determining compliance with this standard, the EPA has developed a modeling approach for estimating 1-hour NO₂ concentrations that is comprised of 3 tiers: Tier 1, the most conservative approach, assumes a full (100%) conversion of NO_x to NO₂; Tier 2 applies a conservative ambient NO_x/NO₂ ratio of 80% to the NO_x estimated concentrations; and Tier 3, which is the most precise approach, employs AERMOD's Plume Volume Molar Ratio Method (PVMRM) module. The PVMRM accounts for the chemical transformation of NO emitted from the stack to NO₂ within the source plume using hourly ozone background concentrations. When Tier 3 is utilized, AERMOD generates 8th highest daily maximum 1-hour NO₂ concentrations or total 1-hour NO₂ concentrations if hourly NO₂ background concentrations are added within the model.

Per the *CEQR TM*, a Tier 1 approach is initially applied, followed by a Tier 2 application of NO_x/NO₂ ratio of 80% to the NO_x modeled concentration to determine whether violation of the NAAQS is likely to occur. A less conservative Tier 3 approach is then applied if exceedances of the 1-hour NO₂ NAAQS were estimated.

New York State Standards

As mentioned, New York State has adopted the national standard, NAAQS. In addition, the New York State Department of Environmental Conservation (NYSDEC) has established guidelines for maximum allowable concentration of “noncriteria pollutants,” which are potentially toxic or carcinogenic pollutants. The maximum allowable guidelines set a maximum 1-hour and annual averaging time concentrations and are published in the DAR-1 AGC/SGC Table, where AGC/SGC refers to Annual and Short-term Guideline Concentrations. The most recent DAR-1 guidelines were created on August 10, 2016.

NYSDEC also regulates pollutants that produce discomfort due to odors, where significant discomfort is evaluated on quantity, characteristic or duration.

NYC Guidelines

In addition to the NAAQS, the *CEQR TM* requires that projects subject to CEQR apply a PM_{2.5} and CO significant impact criteria (based on concentration increments). These criteria are called *de minimis* and they are more stringent than the NAAQS and the state standards as the criteria set a maximum increase of pollutant concentration that is below the national standard. If the estimated impacts of a proposed project are less than the *de minimis* criteria, the impacts are not considered to be significant. As outlined in the *CEQR TM*, CO significant impacts are evaluated as follow:

- An increase of 0.5 parts per million (ppm) or more in the maximum 8-hour average CO concentration at a location where the predicted No-Action 8-hour concentration is equal to 8 ppm or between 8 ppm and 9 ppm; or
- An increase of more than half the difference between baseline (*i.e.*, No-Action) concentrations and the 8-hour standard, when No-Action concentrations are below 8 ppm.

Per the *CEQR TM*, significant adverse PM_{2.5} concentration is determined by:

- Predicted 24-hour maximum PM_{2.5} concentration increase of more than half the difference between the 24-hour background concentration and the 24-hour standard; or
- Predicted annual average PM_{2.5} concentration increments greater than 0.1 µg/m³ at ground level on a neighborhood scale (*i.e.*, the annual increase in

concentration representing the average over an area of approximately 1 square kilometer, centered on the location where the maximum ground-level impact is predicted for stationary sources; or for mobile sources, at a distance from a roadway corridor similar to the minimum distance defined for locating neighborhood scale monitoring stations); or

- Predicted annual average PM_{2.5} concentration increments greater than 0.3 µg/m³ at any receptor location for stationary sources.

Background Concentrations

Determination of significant impact criteria is evaluated by adding the background concentrations at the nearest NYSDEC monitoring station to the concentrations of criteria pollutants in the ambient air of the project area.

Background concentrations of NO₂, CO, PM₁₀, and PM_{2.5}—the criteria pollutants of main concern for the sources in the study area—were obtained from the NYSDEC’s annual report for 2016 at the nearest monitoring stations. **Table 17-3** shows the background concentrations.

Table 17-3. Background Concentration at the Nearest Monitoring Station (NYSDEC 2016 Report).

Pollutant	Averaging Period	Background Concentration	Monitoring Station
NO ₂	1-Hour Concentration	108.3 µg/m ³	Botanical Garden
	Annual Arithmetic Average	38 µg/m ³	
PM _{2.5}	24-Hour Concentration	24.0 µg/m ³	IS 52
	Average of 3 Consecutive Annual Means	9.0 µg/m ³	
PM ₁₀	24-Hour Concentration	37 µg/m ³	IS 52
CO	Maximum 1-Hour	1.86 ppm	Botanical Garden
	Maximum 8-Hour	1.1 ppm	

The *de minimis* criteria for CO and PM_{2.5} were evaluated as described in the NYC Interim Guidelines. The concentrations’ thresholds are presented below:

- CO 8-hour 3.95 ppm
- 24-hour PM_{2.5} 5.5 µg/m³
- Annual PM_{2.5} 0.3 µg/m³

Mobile Source Analysis

Introduction

Projects may result in significant mobile source impacts when they create mobile sources of pollutants, change traffic patterns, or add new uses near mobile sources of pollutants. Per CEQR guidelines, a detailed analysis is conducted to predict whether the Proposed Actions could potentially have a significant adverse air quality impact if certain threshold criteria are met or exceeded, while proposed projects that do not meet or exceed the threshold criteria (screen out) are not expected to have a mobile source impact. Projects that require a detailed analysis model the ambient air CO and PM₁₀/PM_{2.5} concentrations – the mobile source pollutants of concern – and compare the modeled concentrations with the applicable air quality standard.

Mobile source impacts are a function of vehicular related emissions and the pollutant's dispersion. Emission of vehicular mechanical components are generated with the latest EPA's Mobile Vehicle Emission Simulator 2014a version (MOVES2014a). Emission of dust generated by vehicle travelling on paved roadways are added to the MOVES2014a emission to estimate total particulate matter emissions. The pollutants' concentrations at sensitive receptors are modeled with the EPA's CAL3QHC/R or AERMOD Gaussian dispersion models. Dispersion analysis of emission generated in parking facilities may use the spreadsheet and formula referenced in the *CEQR TM* appendices.

Screening Analysis

Project-Generated Traffic

Per the *CEQR TM*, localized increases in CO and PM levels may result from increased vehicular traffic and/or changed traffic patterns in the study area as a consequence of the proposed action. Screening analyses for CO and PM_{2.5} were therefore carried out to determine whether the project-generated traffic have the potential to cause significant impact. For purposes of the screening assessment, "project-generated traffic" refers to the number of additional vehicular trips in any given hour under future with-action conditions, compared with the number under future no-action conditions.

As provided in the Transportation analysis, the proposed action would generate a total of 93 (21 inbound and 72 outbound) net vehicle trip ends during the AM peak hour period, 67 (34 inbound and 33 outbound) net vehicle trip ends during the Midday peak hour time period, 111 (72 inbound and 39 outbound) net vehicle trip ends during the PM peak hour time period, and 99 (50 inbound and 49 outbound) net vehicle trip ends during the Saturday peak hour time periods. These net vehicle trip ends include 2 (1 inbound and 1 outbound) trucks at each peak hour period. As Blondell Avenue is a one-

way street, only the inbound traffic would travel through the intersection of Blondell Avenue and Westchester Avenue.

For this area of the city, the threshold volume for a detailed analysis of CO concentration, using MOVES2014 and CAL3QHC/R or AERMOD, is an increment of 170 vehicles. PM_{2.5} threshold criterion is an increment of applies heavy-duty diesel vehicles (HDDVs) screen.

The maximum trip generation increment between the future no-action and the future with-action scenarios, 111 vehicle trips during the PM peak hour, does not exceed the threshold of 170 vehicular trips. Therefore, no CO detailed analysis was required.

According to the *CEQR TM*, a PM_{2.5} detailed analysis is required if a threshold criterion, determined by project-generated peak hour heavy-duty diesel vehicles (HDDVs) traffic or its equivalent in vehicular emissions, is exceeded. The threshold criteria depend on the type of road and the incremental vehicular traffic as follows:

- 12 or more HDDV for paved roads with 5,000 vehicles;
- 19 or more HDDV for collector roads;
- 23 or more HDDV for principal and minor arterials; or
- 23 or more HDDV for expressways and limited access roads.

Blondell Avenue has a local road (paved road) functional classification and Westchester Avenue has a principal arterial functional classification. According to DEP guidance, the minor leg of an intersection determines its classification. Therefore, the threshold volume for a detailed analysis of PM_{2.5} concentration is an increment of 12 HDDV vehicles.

As the PM_{2.5} screen does not apply to passenger cars, the NYSDEC vehicle population by source type database (part of MOVES2014a database for the county of the Bronx) was consulted. The database shows that there are 211, 160, and 142,056 passenger cars and passenger trucks in the Bronx. This translates to 56.1% and 43.9% passenger cars (LDGV) and passenger trucks (LDGT1) distribution respectively, and at most 16 net equivalent trucks trip ends (31 LDGT1 and 1 HDDVs) during the PM peak hour period. Assuming the truck is HDDVs 6 or 7 (dump trucks, fuel trucks, and beverage trucks), the proposed actions would result in 16 equivalent trucks traveling on Blondell Avenue (local road). This exceeds the 12 HDDV local road threshold. Therefore, an analysis was conducted to determine whether vehicular emissions at Blondell Avenue and Westchester Avenue intersection can cause an exceedance of a NAAQS or the NYC PM_{2.5} significant impact criteria using MOVES2014 and AERMOD.

Parking Facilities Screen

Based on CEQR guidelines, the maximum capacity of parking facilities is evaluated with a threshold capacity to predict whether there is potential for significant adverse air quality impacts. If the maximum capacity of the parking facility is less than the threshold capacity, the vehicular emission is not predicted to result in a significant adverse air quality impact. If the maximum capacity is more than the threshold capacity, there is a potential for a significant adverse air quality impact, and a detailed analysis is conducted.

The proposed action would contain three parking garages: 225, 19, and 21 spaces at Projected Development Site 1, Projected Development Site 3, and Projected Development Site 4, respectively. Per CEQR guidelines, the threshold capacity is 85 off-street parking spaces.

Projected Development Site 3 and Projected Development Site 4 are not expected to exceed the 85 parking spaces threshold criterion. Therefore, no detailed air quality analysis is required, and no significant mobile source air quality impacts are expected as a result of these projected developments.

Projected Development Site 1 exceeds the 85-parking space threshold criterion and therefore requires a detailed analysis.

Detailed Analysis

Methodology

Project-Generated Traffic

As the HDDVs PM_{2.5} screening analysis for one of the peak hour periods failed, a detailed analysis using MOVES2014a and AERMOD dispersion model were used to predict the PM_{2.5} concentrations. The analysis included both evaluation with the NAAQS and the NYC Guidelines. The concentrations (24-hour and annual PM_{2.5}) of the With Action scenario were compared with the NAAQS. The NYC Guidelines, the *de minimis*, were evaluated by comparing the differences of the With Action scenario with the No Action scenario.

With Action and No Action traffic volumes and vehicle classifications were provided by the transportation analysis for this project. This included traffic condition per link. The No Action scenario assumed that vehicles are traveling at an average speed of 20 mile per hour. The With Action scenario assumed 15 mile per hour. A review of NYS Department of Transportation data for station 011243, located on Westchester Avenue, shows that the speed assumption is reasonable.

Per *CEQR TM* and the EPA's MOVES2014 user guide, links (roadways) were modeled as free flow links. Each link specified 0 average grade, length of 1-mile, 100 vehicles, and one specific vehicle type. The MOVES output in grams per vehicle mile were converted to gram per hour using the number of vehicle and links' lengths used in the AERMOD model. Emissions of dust generated by vehicles traveling on paved roadways were added to estimate total particulate matter emission factors. Per the *CEQR TM*, a silt loading factor of 0.4 g/m² for local roads and 0.10 g/m² for principal and minor arterials were used for Blondell Avenue and Westchester Avenue, respectively. A standard average fleet vehicle weight of 3-tons was used in the analysis.

The dispersion analysis was conducted using the USEPA's AERMOD dispersion model version 16216r and AERMET version 14134. All dispersion analyses used the calculated emission factors, flat terrain, and elimination of calms. The default urban roughness coefficient of 1.0 meter with a population of 1,700,000 were used. Two models were run: The No Action scenario; and, the With Action scenario.

Westchester Avenue and Blondell Avenue west of Westchester Avenue were modeled for 1,000 feet in the dispersion analysis. Blondell Avenue east of Westchester Avenue specified links' lengths corresponding to the actual roadways' lengths. Links' widths specified the actual widths.

The EPA PM-Hot Spot 3-Day Training fleet volume-weighted average procedure was used to calculate the sources' release heights and initial vertical dimensions. A source release height of 1.3 meter and 3.4 meter for light-duty and heavy-duty vehicle respectively were applied. The source initial vertical dimension of 2.6 meter and 6.8 meter for light-duty and heavy-duty vehicle respectively were applied to account for the vehicle-induced turbulence. These factors were applied for both the With Action and No Action scenarios.

Sensitive receptors were placed at 1.83-meter-high and in the middle of the sidewalks along Westchester Avenue and Blondell Avenue, at 10 feet intervals for the short-term concentration, and 15 meters from the curb and at 10 feet intervals for the annual concentration. The AERMOD models were run with both the short-term and annual receptors. The first 128 receptors were for the 24-hour PM_{2.5} analysis; the other 100 receptors were for the annual PM_{2.5} analysis.

All analyses were conducted using the latest five consecutive years of meteorological data (2013-2017). Surface data was obtained from La Guardia Airport and upper air data was obtained from Brookhaven station, New York. These meteorological data provide hour-by-hour wind speeds and directions, stability states, and temperature inversion elevations over the 5-year period. Meteorological data were combined to develop a 5-year set of meteorological conditions, which was used for the AERMOD

modeling runs and Anemometer height of 9.4 meters was specified per Lakes Environmental Software Inc.

As previously mentioned, the With Action scenario was compared with the NAAQS. The *de minimis* criteria were evaluated by comparing the concentrations' increments for each receptor. In addition, the result of the annual PM_{2.5} analysis was compared with the *de minimis* concentration increment based on a neighborhood scale of 0.1 µg/m³.

Parking Garage

Projected Development Site 1 would include 225 attended parking spaces with an entrance on Blondell Avenue on the cellar level. The lower level of the parking garage would occupy 24,800 square feet with a 155 feet ramp length at a 14% grade. As determined by the preliminary traffic analysis and shown in **Table 17-4**, there is a maximum of 45 vehicles entering the parking garage in the PM hour between 16:15 to 17:15, and a maximum of 39 vehicles exiting the parking garage in the AM hour between 7:30 to 8:30. These traffic data were initially considered as a worst-case scenario. If an impact was predicted, an average peak hour traffic was considered, where applicable.

Table 17-4. Peak Hours Parking Demands: AM, Midday, PM, and Weekend.

Peak Daily Period	Entering	Exiting	Total
AM	16	39	55
Midday	36	36	72
PM	45	30	75
Weekend	37	36	73
Worst Case	45	39	84
Average	32	35	67

Per *CEQR TM*, vehicles exiting the parking garage idle for 1 minute before starting to travel to the parking lot exit and all parking garage vehicles are assumed to drive at a speed of 5 miles per hour. In addition, entering and exiting vehicles are assumed to travel a mean travel distance of two-thirds of the width and the length of the parking garage plus the ramp's length.

The following conditions, as outlined in the *CEQR TM*, are assumed in the analysis to simulate the maximum potential air quality impacts:

- Pollutants within the garage are exhausted through a single vent situated above the parking garage entrance at 12 feet above grade.
- A receptor is placed at 6 feet high and 6 feet from the parking garage entrance, directly downwind from the garage's exhaust vent, to simulate a pedestrian on the adjacent sidewalk of the parking garage.
- A receptor is placed at 6 feet high and at the opposite sidewalk, directly downwind from the garage's exhaust vent.
- A receptor is placed 5 feet above the garage's exhaust vent to simulate a receptor placed in a window above the exhaust vent.
- Wind speed is assumed to be 1 meter per second.
- The garage ventilation rate is assumed to be the minimum rate as required by the New York City Building Code and outlined in the *CEQR TM*.
- The impact of the pollutants generated by on-street traffic are added to the receptor placed on the opposite sidewalk from the parking garage. These include both emissions from vehicular mechanical components and dust generated by vehicles travelling on paved roads.

In addition, and per the Department of City Planning request, as Projected Development Site 1 would include a playground / lawn on top of the cellar garage, the garage's vent was located 3 feet above grade, a receptor was placed 4 feet above grade and 5 feet from the vent. The annual PM_{2.5} used the daily average traffic entering and leaving the garage.

Pollutants from vehicle emissions were generated by the EPA's Motor Vehicle Emission Simulator, MOVES, as outlined below. Pollutants concentrations from the garage's exhaust vent and from the on-street traffic emissions were calculated using the spreadsheet and formula referenced in the *CEQR TM Appendices*.

Incremental on-street traffic accumulation (111 vehicles) was considered for the NYC Guidelines, *de minimis*. A specific receptor was considered for the annual *de minimis* criterion as the garage's exhaust vent is a stationary source.

Per *CEQR TM*, a persistence factor of 0.7 was applied to the 1-hour CO concentrations to evaluate the 8-hour CO concentrations. According to the EPA's *AERSCREEN User Guide*, the 24-hour concentrations of PM₁₀ and PM_{2.5} were evaluated by multiplying the hourly concentrations by a 0.6 persistence factor, and the annual concentration of PM_{2.5} was evaluated by multiplying the hourly concentration by a 0.1 persistence factor.

Emission Factors

MOVES can be used to calculate emission rates of criteria air pollutants, greenhouse gas emissions, and some hazardous air pollutants for both onroad motor vehicles and

nonroad equipment. MOVES models calculate emissions at the national, county, and project level by use of databases and by specifying the characteristics (Run Specification) of the scenario that is modeled.

The onroad emission factors that MOVES produces are either grams/vehicle-mile or grams/hour. For a microscale analysis, project level scale – which is the finest level of modeling – and a specific hour of the day are specified and the model output emission factors for each roadway (link) specified in the database. **Table 17-5** shows the Run Specification and databases that were used to develop CO, PM_{2.5}, and PM₁₀ emission factors.

Table 17-5. MOVES2014a Run Specification and Database Inputs.

Run Specification		Databases	
Scale	Project	I/M Program	NYSDEC
Calculation Type	Inventory ⁽¹⁾	Age Distribution	NYSDEC
	Emission Rate ⁽²⁾	Fuel	NYSDEC
Time Span (Year/Month/Day/Hour)	2027/January/Weekday/PM hour	Meteorology Data	NYSDEC
Geographic Bounds	Bronx, NY	Links	Project input
Vehicle and Equipment (Fuels/Source Use Type)	Gasoline/Passenger Car (garage)	Links Source Type	Project Input
	Gasoline/ Passenger Car/Truck (intersection)		
	Diesel / Short-haul combination truck (intersection)		
Road Type	Urban Unrestricted Access		
Pollutants and Processes			
CO	Running Exhaust and Crankcase Running Exhaust		
PM ₁₀ ⁽³⁾ /PM _{2.5} ⁽⁴⁾	Running Exhaust, Crankcase Running Exhaust, Brakewear, Tirewear		
Total Gaseous Hydrocarbons	Running Exhaust		

Note:

1. The parking garage Idle Link’s emission produced by specifying Inventory for the Calculation Type
2. Free flow links’ emissions produced by specifying Emission Rate Calculation Type
3. Primary Exhaust PM₁₀ - Total, Primary PM₁₀ - Brakewear Particulate, and Primary PM₁₀ - Tirewear Particulate specified

4. Primary Exhaust PM_{2.5} - Total, Primary Exhaust PM_{2.5} - Species, Primary PM_{2.5} - Brakewear Particulate, Primary PM_{2.5} - Tirewear Particulate specified

In addition to exhaust running PM_{2.5}/PM₁₀ emissions, vehicle-related PM_{2.5}/PM₁₀ emissions of dust generated by vehicles traveling on paved roadways (Blondell Avenue) were added to estimate total particulate matter emission factors. Depending of the silt content on a road, re-entrained road dust can be a significant contributor to the total PM_{2.5}/PM₁₀ concentration. Per the *CEQR TM*, a silt loading factor of 0.4 g/m² for local roads, 0.10 for principal and minor arterials, and standard average fleet vehicle weight of 3-tons were used in the analysis. In addition, based on DEP guidance, the conservative assumptions of “dry” road conditions were used for the short-term calculation (per DEP, annual fugitive dust emission is negligible).

Detailed Analysis Results

Project-Generated Traffic

The results of the PM_{2.5} intersection analyses were compared with both the 24-hour/annual PM_{2.5} significant impact criterions (*de minimis*) and the NAAQS. The With Action concentration were:

- 24-hour PM_{2.5} predicted concentrations of 8.9 µg/m³ and 32.9 µg/m³ with background concentration included.
- Annual PM_{2.5} total concentrations of 0.3 µg/m³ and 9.3 µg/m³ with background concentration included.

The incremental (With Action to the No Action) concentrations were:

- 24-hour PM_{2.5} increment of 1.3 µg/m³.
- Annual PM_{2.5} increment of 0.06 µg/m³ (less than or equal to the *de minimis* increment threshold of 0.1 µg/m³ rounded to one significant number).

Therefore, no significant air quality impacts are expected as a result of the project-generated traffic.

Parking Garage

Table 17-6 shows the results of the parking garage analysis.

Table 17-5. Parking Garage Air Quality Impact.

	Near Sidewalk		Far Sidewalk		Window Above Vent		Playground	
CO (ppm)								
Averaging	1-hour	8-hour	1-hour	8-hour	1-hour	8-hour	1-hour	8-hour

Period								
Garage	0.11	0.08	0.084	0.065	0.13	0.09	0.26	0.18
Line Source	N.A.	N.A.			N.A.	N.A.	N.A.	N.A.
Background concentration	1.86	N.A.	1.86	N.A.	1.86	N.A.	1.86	N.A.
Total concentration	2.0	0.08	2.0	0.07	2.0	0.09	2.1	0.18
NAAQS	35	9	35	9	35	9	35	9
<i>de minimis</i>	N.A.	3.95	N.A.	3.95	N.A.	3.95	N.A.	3.95
Impact	No		No		No		No	
PM_{2.5} (µg/m³)								
	24-hour	Annual	24-hour	Annual	24-hour	Annual	24-hour	Annual
Garage	0.97	0.17	2.06	0.32	0.97	0.16	2.27	0.31
Line Source	N.A.	N.A.			N.A.	N.A.	N.A.	N.A.
Total concentration	1.0	0.2	2.1	0.3	1.0	0.2	2.3	0.3
<i>de minimis</i>	5.5	0.3	5.5	0.3	5.5	0.3	5.5	0.3
Impact	No		No		No		No	
PM₁₀ (µg/m³)								
	24-hour		24-hour		24-hour		24-hour	
Garage	5.2		3.5		5.9		12.2	
Line Source	N.A.		17.9		N.A.		N.S.	
Background concentration	37		37		37		37	
Total concentration	42		58		43		49	
NAAQS	150		150		150		150	
Impact	No		No		No		No	

The analysis concluded that all the pollutants are within the NAAQS and the *de minimis* criteria. Therefore, no significant air quality impacts are expected as a result of the parking garage facility.

HVAC System Analysis

Introduction

Per the *CEQR Technical Manual*, the HVAC analysis considers the potential for emissions from the HVAC system of the proposed project to significantly impact existing land uses (project-on-existing) within 400 feet, and the potential of the proposed project to significantly impact each other (project-on-project).

As outlined in the *CEQR Technical Manual*, the analysis of buildings' HVAC systems follows stationary sources methodology, and based on CEQR guidelines, a preliminary screening analysis is to be conducted as a first step to predict whether the potential impacts of the heat and hot water system boiler emissions can be significant. This CEQR screening procedure is applicable to buildings that are not less than 30 feet from the nearest building of similar or greater height. Otherwise, a detailed dispersion analysis is required.

Screening Analysis

Screening analyses were performed, using the methodology described in the *CEQR Technical Manual*, to determine if the heat and hot water system of the RWCDs buildings would result in potential air quality impacts to another building in the area. This methodology determines the threshold of development size below which the action would not have a significant impact.

Impacts from boiler emissions are a function of fuel type, stack height, minimum distance from the source to the nearest building of similar or greater height, and the building floor area in gross square feet (gsf).

The anticipated developments (RWCDs) within the Affected Area would consist of six buildings, each with its own heat and hot water system. The proposed developments would be 95 feet in height and would contain a total of 449,828 gsf of floor area.

Project-on-Existing Screening Analysis

Screening analysis is only applicable to a single smokestack. However, for purpose of a cumulative analysis, emissions from multiple stacks could be combined in a single stack situated as close as possible to the receiving building. As such, the combined square footage of proposed project, 449,828 gsf, was used in the analysis of the potential impact on existing land uses. **Figure 17-1** shows the screening analysis of the project-on-

existing, where 95 feet building height—all the proposed buildings’ roof heights—was assumed.

Figure 17-1. The Proposed Project Minimum Distance - HVAC Screen All Fuels Nomograph

**Figure 17-3:
Stationary Source Screen**

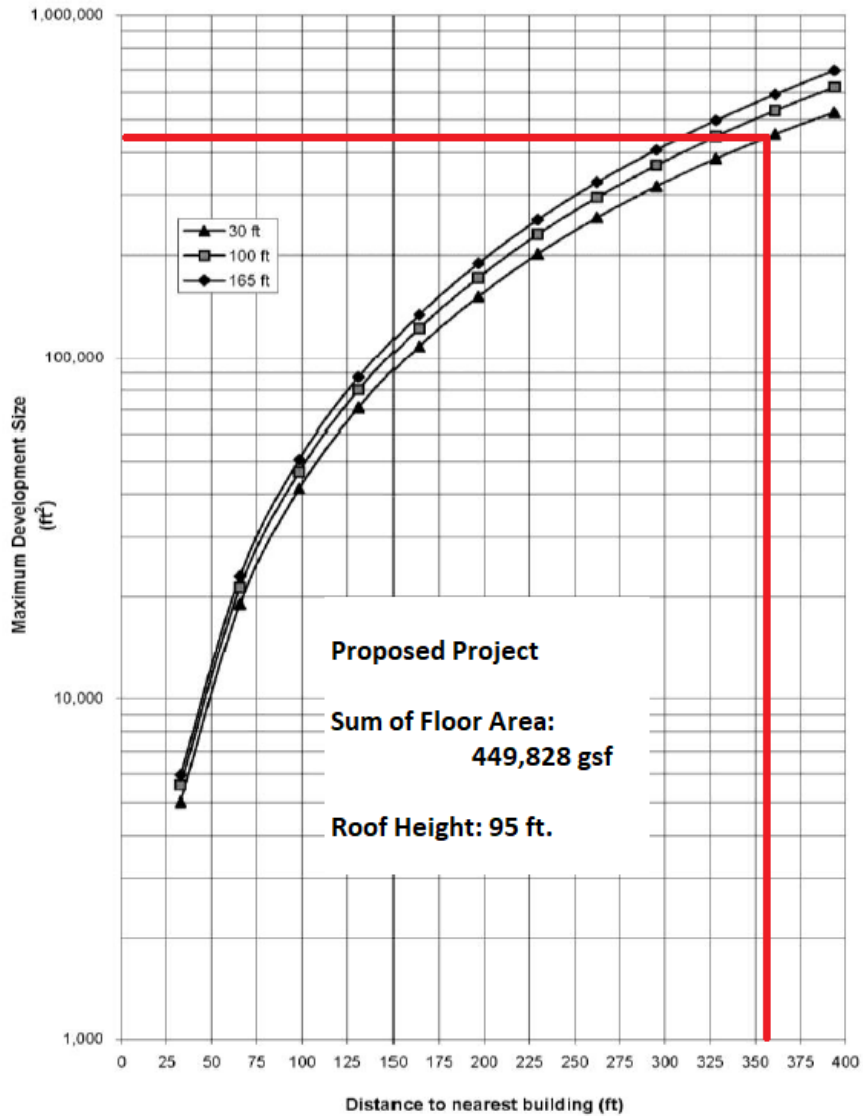

The screening analysis nomograph shows that a detailed analysis would be required for any existing land uses that is 95 feet or higher and at a distance of less than 360 feet from the Affected Area.

A review of existing land uses through the New York City Zoning and Land Use (ZoLa) interactive mapping application and Google Earth imaging map showed that there are no existing buildings similar to or greater in height than the proposed buildings within 360 feet. Therefore, the Proposed Action passes the screening analysis regarding its potential impact on existing land uses.

Project-on-Project Screening Analysis

As previously mentioned, the screening analysis is only applicable to a single smokestack, and this CEQR screening procedure is applicable to buildings that are not less than 30 feet from the nearest building of similar or greater height. **Figure 17-2** shows the Projected Development Sites plotted in Google Earth.

Figure 17-2. The Projected Development Sites Plotted in Google Earth.

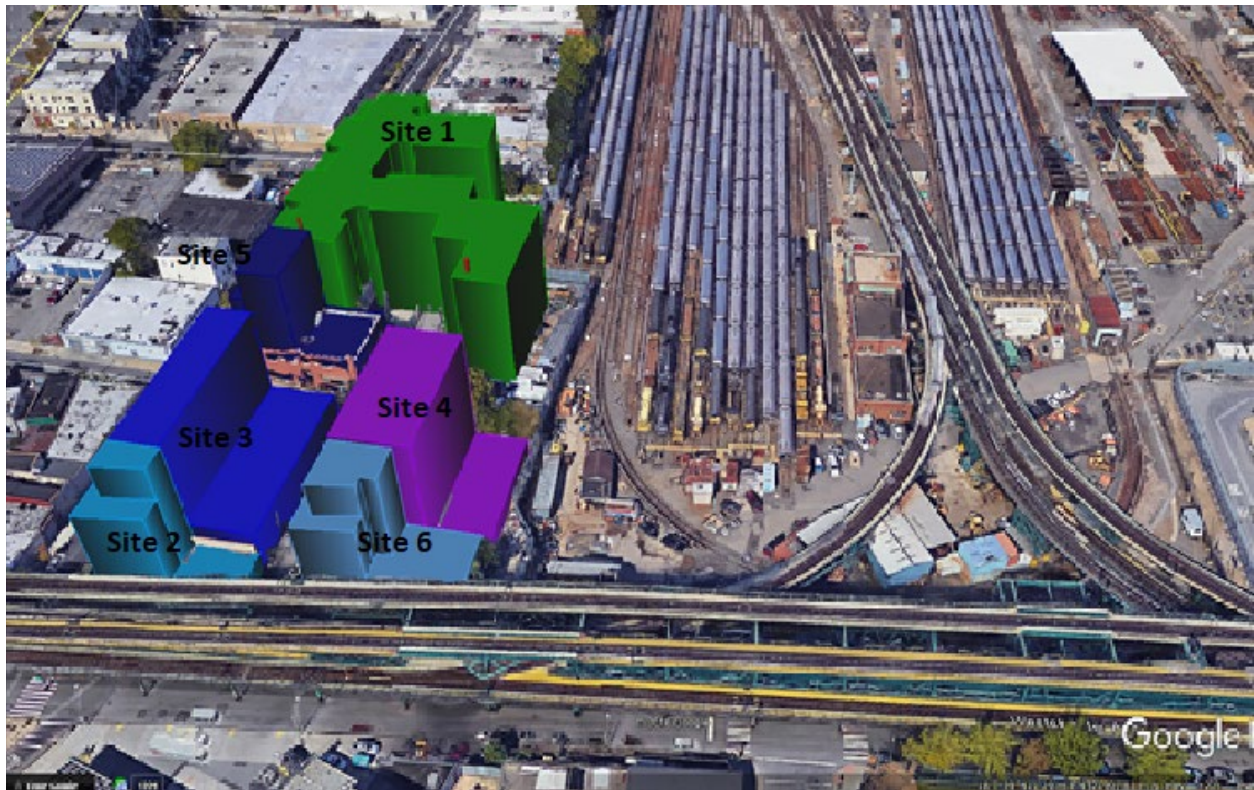

As seen in **Figure 17-2**, each development abuts another development and each development is in close proximity to at least three other developments. As such, the CEQR screening analysis is not applicable, and project-on-project detailed analysis is required.

AERMOD Detailed Analysis

Per CEQR guidelines, buildings that are similar to or greater in height than a source building could be adversely impacted. As all the projected for development buildings are 95 feet tall, each of the six projected for development building could be adversely affected by each or all of the other buildings. As such, the EPA's AERMOD dispersion model version 16216r was used to conduct cumulative air dispersion analyses. Per *CEQR TM*, the analyses were conducted assuming stack tip downwash, urban dispersion surface roughness length of 1.0-meter, elimination of calms, population of 1,700,00, and Building Profile Input Program (BPIP) was run with the downwash effect enabled for the downwash effect on plume dispersion.

As seen in **Figure 17-2**, the Projected Development Sites 2-6 ground floor levels would cover the entirety of the lot, and the buildings portion above the 1st floor would feature setback distances, providing for residential back yards. The buildings also have setback distances above the 7th floors. Projected Development Site 1 was modeled per the Site Plans provided by the building's architect. As such, buildings' stacks were assumed to be located on the buildings' highest levels. In addition, Projected Development Site 1 is of an irregular shape (not a rectangular prism). As such, the analysis considered two building stacks' positions for the Projected Development Site 1: near Projected Development Site 5 and close to Blondell Avenue (south stack); and closer to the rail tracks and Projected Development Site 4 (north stack).

For each air dispersion analysis, stacks were located as close as possible to the receiving building. For simplicity, and yet more conservative analysis, the emissions of Projected Development Site 2 and 3 were combined in a single stack, as well as the emissions of Projected Development Site 4 and 6, where applicable.

The developments heat and hot water systems would be heated by natural gas. Per the *CEQR Technical Manual*, the pollutants of concern for natural gas fueled boilers are NO₂ and PM_{2.5}. The boilers heat capacities were calculated from the annual fuel usage and the buildings' gross floor areas. Pertinent values were obtained from the *CEQR Technical Manual Appendix*, and the assumption that all fuel would be consumed during the 100-day (or 2,400 hour) heating season. **Table 17-7** shows the NO₂ and PM_{2.5} emission rates, both short-term and annual.

Table 17-7. The Projected Development Sites 1-6 Estimated Short-term and Annual Emission Rates.

Site ID	Residential Floor Area	Non-Residential Floor Area	NO ₂ Emission factor ⁽²⁾		PM _{2.5} Emission factor ⁽¹⁾	
	ft ²	ft ²	g/sec	g/sec	g/sec	g/sec
			1-hour	Annual	24-hour	Annual
Site 1	198,683	62,977	7.66E-02	2.10E-02	5.82E-03	1.59E-03
Site 2	11,686	1,930	4.08E-03	1.12E-03	3.10E-04	8.50E-05
Site 3	64,552	21,807	1.84E-02	5.05E-03	1.40E-03	3.84E-04
Site 4	66,922	20,933	1.92E-02	5.27E-03	1.46E-03	4.01E-04
Site 5	23,453	4,068	6.98E-03	1.91E-03	5.30E-04	1.45E-04
Site 6	19,625	3,236	5.85E-03	1.60E-03	4.45E-04	1.22E-04

The diameters of the stacks and the exhausts' exit velocities were estimated based on values obtained from the New York City Department of Environmental Protection (DEP) "CA Permit" database for the corresponding boiler size (i.e., rated heat input or million Btu per hour). The stacks' exit temperatures were assumed to be 300°F (423°K), which is appropriate for boilers. The New York City Building Code (Building Code) requires that a rooftop stack should be at least 10 feet away from the edge of the roof and at least 3 feet higher than the roofline, so each HVAC stack was located on its building's highest level, 10 feet from the edge of the roof, and as close as possible to the receiving building.

Receptors on receiving buildings were placed at sensitive areas, where people have continuous access, at 10-foot increments and 6-foot above floor level. Receptors were also placed 6 feet above terraces, as people have continuous access, which defines sensitive areas, and at the 9th floor where buildings are contiguous.

All analyses were conducted using the latest five consecutive years of meteorological data (2013-2017). Surface data was obtained from La Guardia Airport and upper air data was obtained from Brookhaven station, New York. These meteorological data provide hour-by-hour wind speeds and directions, stability states, and temperature inversion elevations over the 5-year period. Meteorological data were combined to develop a 5-year set of meteorological conditions, which was used for the AERMOD modeling runs and Anemometer height of 9.4 meters was specified per Lakes Environmental Software Inc.

Per Lakes Environmental Inc., PM_{2.5} special procedure which is incorporated into AERMOD calculates concentrations at each receptor for each year modeled, averages those concentrations across the number of years of data, and then selects the highest values across all receptors of the 5-year averaged highest values.

AERMOD calculate concentrations according to the dispersion option, pollutant and averaging time, and output specified in the model, where the model is capable of handling multiple sources in a single run. As such, each pollutant was modeled separately and two stacks, one for the short-term and the other for annual averaging times, were created. Each stack (or group of stacks) was placed in a different source group and AERMOD outputs concentration for each group is read from the output file. As previously mentioned, two locations were considered for the stack of Projected Development Site 1, which required additional groups of stacks. The reported values are the maximum cumulative impact concentrations for either location of Projected Development Site 1's stack. However, the AERMOD output files, provided with the backup files, contain each group impact concentrations.

Results of Dispersion Analyses

As stated above under AERMOD Detailed Analysis, each pollutant averaging time was modeled twice—with building wake effect enabled/disabled. The predicted concentrations are the highest concentration of these two building wake effect options. The results are compared with the 24-hour/annual PM_{2.5} significant impact criteria, and the 1-hour/annual NO₂ NAAQS. Result of the project-on-project HVAC NO₂ and PM_{2.5} analyses are shown in Table 17-8.

Table 17-8. Detailed HVAC analyses results.

Receiving Development Site ID	24-hr PM _{2.5} Impact	Annual PM _{2.5} Impact	1-Hour NO ₂ Impact	Annual NO ₂ Impact
	µg/m ³	µg/m ³	µg/m ³	µg/m ³
Site 1	0.65	0.03	136.5	35.5
Site 2	2.88	0.09	36.2	161.9
Site 3	1.40	0.06	166.0	35.9
Site 4	1.61	0.08	176.4	36.1
Site 5	1.56	0.08	185.6	36.1
Site 6	2.67	0.10	164.0	36.5
NAAQS/de minimis	7.65	0.3	188	100

As shown in **Table 17-8**, the PM_{2.5} concentrations are less than the significant impacts criteria, and both the 1-hour and annual NO₂ predicted concentrations are less than the 1-hour and annual NAAQS.

Therefore, with (E) Designations in place, the emissions from each Site would not significantly impact any of the other Sites.

Major Sources and Odor Producing Facilities

No existing large combustion sources, such as power plants, cogeneration facilities, etc., located within 1,000 feet of the proposed development were identified. The only sites of interest were the Lewis and Clark Special Ed school (Block 3983, Lot 1) and the schools at the 3000 East Tremont Avenue complex (Block 5368, Lot 1 and 2). The two locations are not registered as Title V facilities, and their boilers are smaller than 20 MMBtu/hour per DEP's CATS information system. As such, no analysis was warranted. No odor producing facility was identified in the 1,000 feet study area.

Toxic Air Emissions from Industrial Facilities

Information regarding potential emissions of toxic air pollutants from existing industrial sources was developed using the following procedure:

A study area was developed that includes all industrial facilities with potential air toxic emissions located within 400 feet of the Affected Area using Zoning and Land Use application (ZoLa);

New York City's Open Accessible Space Information System Cooperative (OASIS), Google Street View, the New York City Department of Building (DOB) database, and online searches were used to identify and categorize facilities;

A fieldwork observation was conducted to affirm the online study findings and to identify any other likely industrial source in the study area;

A search was performed to identify permits listed in the EPA Envirofacts database in this study area;

A formal request with blocks and lot numbers necessary to identify industrial source permits within 400 feet of the Affected Area was submitted to NYCDEP; and

Air permits for active permitted industrial facilities within 400 feet of the Affected Area that are included in the DEP Clean Air Tracking System database (or permit applications) were obtained, and emission rates were developed from the certificate in order to conduct the toxic air analysis.

The result of the study identified numerous commercial, industrial, or processing facilities that are likely to have NYC operational permits. A list of these facilities is presented in **Table 17-9**. Two facilities have operational permits from the NYCDEP and four of these facilities are Projected Development Sites.

The facilities with NYCDEP operational permits are:

- A&A Auto Body Inc. at 1341 Blondell Avenue - Permit: PB014002
- BP Gas Station at 91 Westchester Avenue - Permits: GA068485, GA007889, GB462703

The four facilities in the Affected Area are:

- 2601 Westchester Avenue (bock 4133, Lot 1) - Projected Development Site 2
- 1306 Cooper Avenue (Block 4133, Lot 63) - Projected Development Site 4
- 1340 Blondell Avenue (Block 4134, Lot 2) - Projected Development Site 3
- 1346 Blondell Avenue (Block 4134, Lot 4) - Projected Development Site 1

Table 17-9. Sites of Interest for Air Quality Within 400 feet of Rezoning Area.

Block/Lot	Address	Field Observation	Field Observation/Notes
3859/1	1430 Ferris Place	Adult day care center	
3859/11, 18	122 Westchester Avenue	Retail - multiple stores	
3859/23, 30	115 East Tremont Avenue	Resturant	
4071/10	2630 Fink Avenue	Iron Works	
4071/12	1315 Blondell Avenue	Servco Industries - cleaning contractor office/warehouse	
4071/17	1303 Blondell Avenue	Auto Repair Shop	
4072/1	63 Westchester Square	Glass/Metal Supply Corporation, Retail	
4072/5	58 Westchester Avenue	Retail/counseling office	
4072/16	1345 Blondell Avenue	(2) Auto Collision Shops: Xclusive Auto Collision, Platinum Auto Work	
4072/19	1341 Blondell Avenue	A&A Auto Body Shop	DEP Permit
4072/23	1331 Blondell Avenue	Auto Repair Shop	
4073/1	44 Westchester Square	Retail, Residential	
4073/14	2619 Ponton Avenue	U.S. Post Office	
4073/23	1369 Blondell Avenue	Auto Body parts Wholesale	
4074/11	2614 Halperin Avenue	Parking	
4074/16	2626 Halperin Avenue	CTL Inc. - analytical testing lab	
4074/24	1401 Blondell Avenue	Fire Sprinkler, Glass & mirror, Electrical Contractor	
4133/1	2601 Westchester Avenue	Auto Repair Shop	P. Development Site 2
4133/2	1312 Blondell Avenue	Tax Service	P. Development Site 3
4133/23	N/A	Railyard	
4133/63	1306 Cooper Avenue	Bakery Supply Shop	P. Development Site 4
4133/12	1342 Cooper Avenue	Parking	
4133/61	2611 Westchester Avenue	Retail	P. Development Site 6
4134/2	1340 Blondell Avenue	Auto/Motorcycle Repair Shop	
4134/4	1346 Blondell Avenue	Towing Yard	
4134/14	N/A	Railyard	
4134/62	1344 Cooper Avenue	Parking	
4134/63	1348 Cooper Avenue	Parking	
4139/1	1402 Blondell Avenue	A Roval Flush	Observed in 5/1/2018
4139/6	1406 Blondell Avenue	Electrical Contractor	
4139/14	N/A	Railyard	
4139/101	1364 Blondell Avenue	DOM's Auto Body	Spray booth next to railyard - Observed
4139/106	1400 Blondell Avenue	A Royal Flush parking	Observed in 5/1/2018
5368/1	2964 East Tremont Avenue	High School	
5380/1	2925 East Tremont Avenue	Home Supply Company	

5380/25	2917 East Tremont Avenue		
5380/27	2923 East Tremont Avenue	Car Wash/Lubratorium	
5380/36	91 Westchester Square	Gas Station	DEP Permit
5380/127	2973 East Tremont Avenue	Restaurant	

Gas stations are not analyzed for microscale projects under CEQR. hence, no analysis is required.

The A & A Auto Body (Block 4072, Lot 19) is an active auto body shop with DEP permit number PB014002. No permits were found for DOM's Auto Body (Block 4139, Lot 1), Xclusive Auto Collision (Block 4072, Lot 16), and Platinum Auto Work (Block 4072, Lot 16). However, the land survey and online search identified these sites as likely air toxic emitters from spray booth operations. Per *CEQR TM*, projects that would result in new uses that may be adversely affected by air-born emissions from existing industrial sources require an assessment of both criteria and non-criteria pollutants emissions. If the industrial source does not have a NYSDEC or DEP permits, but emissions are expected due to the type of manufacturing process, a conservative emission analysis is appropriate. The facilities and their emissions are discussed here:

A & A Auto Body (PB014002)

A&A Auto Body is situated on the east side of Blondell Avenue, directly across the street from Projected Development Site 1. Permit PB014002 is for a spray booth operating 6 hours per day, 250 days per year, with a maximum emission of 1.0 gallon per hour. Permit PB014002 also shows the location of the spray booth stack and its volumetric flow rate and exit temperature.

The contaminants listed in the certificate are solids (NY identification number NY079-00-0) and solvents (NY identification number NY998-00-0). The solids emissions are reduced by a custom filter with 80 percent control efficiency. The certificate also included material safety data sheets (MSDS), showing the composition of the mixture of different compounds.

DOM's Auto Body, Xclusive Auto Collision, Platinum Auto Work

The site study determined that the three facilities are auto body shops, all specializing in auto body repair and color matching, hence the facilities do not paint entire vehicles. The locations of the facilities' stacks were determined in the fieldwork observation. These locations can be seen in Google satellite image too. DOM'S Auto Body's roof height was obtained from the Housing and Development database, accessed through NYC Open Data. The composition of the mixture of different compounds, identified collectively as VOC, was not included in the operational permit. As such, a representative composition by percent weight was obtained from the *Solow Report Table 3*.

A review of 19 DEP permits for auto body facilities shows that most operate 4-6 hours per day (hr/day) and 200-250 days per year (day/yr). These DEP certificates show that the facilities maximum solids emission is 0.065 pounds per hour (lb/hr) and 97.6 pounds per year (lb/yr), and maximum volatile organic compounds (VOC) emission is 3.1 lb/hr and 4,650 lb/yr, similar to the A&A Auto Body emission rate. In addition, the

6 hr/day operation is conservative as freshly painted cars require 1-hour of dry time in a dust free environment. However, the analysis assumed that the three facilities operate 312 day/yr as a conservative approach.

The maximum hourly emission of A&A Auto Body is based on the maximum possible amount of paint sprayed in one hour. The three other auto body facilities also specialize in auto body repair and color matching. Per City Planning guidance, the analysis assumed that the three auto body facilities operating with no DEP permit have similar hourly emission rate as the A&A Auto Body. However, it is noted that in the fieldwork observation/investigation which was conducted at May 2018, the owner/manager of Platinum Auto Work stated that no spray painting is performed in the facility; vehicles are sent to another facility (not in the 400-foot study area) to be painted. The owner/manager of Xclusive auto body stated that no more than 0.5 gallon is sprayed in an hour. 0.5 gallon could potentially result in a maximum VOC emission of 2.6 lb/hr, following the VOC content limits of a Class A Coating Line Per 6 CRR-NY 228-1.4, Table A. This is significantly less than A&A Auto Body VOC emission. The Department of Building database shows that DOM's Auto Body facility installed a spray booth and paint mixing room. The spray booth was observed during the May 2018 fieldwork observation/investigation. Data pertaining to amount of paint used was not available. However, a study of a similar in size (or larger) auto body facility, which was approved by the DEP (CEQR action: *411 Wales Avenue 17BSA149X* in The Bronx), showed that the expected VOC emission for such facility is 3.01 lb/hr; less than the A&A Auto Body VOC emission. Regarding solids emission, National (Subpart 6H) and State regulation require that all spray booths be equipped with a filter with at least 98 percent control efficiency, significantly more restrictive than the A&A Auto Body filter control efficiency. Therefore, using the A&A Auto Body emission rate is a conservative approach.

The maximum hourly emission rate of each facility and 6 hr/day, 312 day/yr activity rates were used to calculate the annual emission rates of the three auto body facilities operating with no DEP permits. This approach yielded annual emission rates of more than 20 percent than the A&A Auto Body emission. The A&A Auto Body is similar in size to the Dom's Auto Body and is a much larger facility than Xclusive Auto Collision and Platinum Auto Work. It is reasonable to assume that a size of a facility is correlated to its annual activity rate. Therefore, a 20 percent greater activity rate is a conservative assumption. As with the A & A Auto Body shop, the contaminants associated with auto body spray booths are solids and solvents.

Auto Body Facilities Emission Rates

The contaminants associated with auto body spray booths are solids (also named particulates) and solvents. Solvents are the VOC which evaporate during the spraying activity and while the coating substance dries. The solids that bind to the sprayed item

dries to a hard surface. The coatings contain 30 to 85 percent solvents by volume and this amount is regulated by the EPA and NYS DEC. Per NYC DEP guidance and as outlined in the EPA AP-42, the analysis assumes that all VOCs are emitted. Each VOC contaminant is analyzed with the SGC/AGC guideline concentration. Particulates are fluid or solids particles grouped together. Per NYSDEC DAR-1, particulates are collectively analyzed with the more stringent concentration guideline. **Table 17-10** shows the solids and VOC emission rates.

Table 17-10. Spray Booth Emission Rates by Groups.

Facility	Contaminant	Control Efficiency (Percent)	Emission Rate (lb/hr)	Emission Rate (lb/yr)
A & A Auto Body (PB014002)	Solids (NY079-00-0)	80	0.065	97.6
	Solvents (NY998-00-0)	0	3.1	4650
Dom's Auto Body	Solids (NY079-00-0)	80	0.065	121.7
	Solvents (NY998-00-0)	0	3.1	5803
Xclusive Auto Collision	Solids (NY079-00-0)	80	0.065	121.7
	Solvents (NY998-00-0)	0	3.1	5803
Platinum Auto Work	Solids (NY079-00-0)	80	0.065	121.7
	Solvents (NY998-00-0)	0	3.1	5803

As seen in **Table 17-10**, the analysis assumed an 80 percent capture efficiency of solids. Per the National (Subpart 6H) and NYS DEC regulations, filters achieving 98 percent capture efficiency of solids emission must be installed on the exhaust of all spray operations. As such, an 80 percent filter capture efficiency is conservative.

In accordance with DEP guidelines, emissions of solids are analyzed as PM₁₀ and PM_{2.5}. The particle size distribution was obtained from the EPA AP-42, *Appendix B1, Page B.1-12, Particle Size Distribution Data and Sized Emission Factors for Selected Sources, Table 4.2.2.8 Automobile and Light-Duty Track Surface Coating Operations, Automobile Spray Booths*. **Table 17-11** shows the PM₁₀ and PM_{2.5} emission rates.

Table 17-11. Auto Body Spray Booth Operations PM₁₀/PM_{2.5} Emission Rates.

Contaminant	Permitted Emission Rate		Fraction of Particle Size	Emission rate			
	lb/hr	lb/yr		Short-term		Annual	
	lb/hr	lb/yr	Percent	lb/hr	g/s	lb/yr	g/s
A&A Auto Body							
PM _{2.5}	0.065	97.6	28.6	1.86E-02	2.34E-03	2.79E+01	4.01E-04
PM ₁₀			46.7	3.04E-02	3.82E-03	4.56E+01	6.56E-04
Dom's Auto Body, Xclusive Auto Collision, Platinum Auto Work (from each facility)							
PM _{2.5}	0.065	121.7	28.6	1.86E-02	2.34E-03	3.48E+01	5.01E-04

PM ₁₀			46.7	3.04E-02	3.82E-03	5.68E+01	8.17E-04
------------------	--	--	------	----------	----------	----------	----------

The mixture of different compounds identified collectively as solvents are VOC (New York identification number NY998-00-0). The VOC as a group does not have a guideline value in the NYSDEC DAR-1 database. As the composition of the coating substance of the three auto body facilities operating with no permit was not known, a representative composition by percent weight was obtained from Table 3 of the Solow Report. Table 3 of the Solow Report lists the composition of contaminants that make up the VOC (solvents) group and provides each compound weight percent. This approach for calculating the emission rates of the different compounds (different solvents) was accepted by NYCDEP in previous environmental impact studies that analyzed operations that have no permit information on solvents.

The MSDS included in the A&A Auto Body certificate was used to identify the contaminants and their weights emitted from the facility. The percent weight of the contaminants was provided in a range. The analysis assumed that the top of the range is emitted. The certificate included MSDSs for two topcoats and a clearcoat. Pollutants used in both the topcoats and clearcoat applied the maximum percent weight. Pollutants identified as VOC applied the VOC emission rate; pollutants identified not as VOC were assumed to be particulate. The MSDS showed that the pollutant Lead Sulfochromate Yellow (CAS No. 1344-37-2) has a range of 0-30 percent weight. BASF, the manufacturer, indicated that they removed the lead-chromate based tinting from its automotive coating. Therefore, the contaminant percent weight was set to zero.

Table 17-12 shows the ingredients that make up the VOC group along with their Chemical Abstract Service (CAS) number by percent weight, and the hourly and annual emission rates calculated as the percent of the total VOC. As previously discussed, a maximum VOC emission rate of 3.1 lb/hr was applied as a conservative approach, and 6 hr/day, 312 day/yr of operation applied for the annual emission rates of the three auto body facilities operating with no DEP permit, yielding emission rate of 5,803 lb/yr each.

Table 17-12. VOC Short-term and Annual Emission Rates from the Spray Booth Operation.

Contaminant name	CAS No.	Percent Weight	1-Hour		Annual	
			lb/hr	g/s	lb/yr	g/s
A&A Auto Body						
Methyl Isobutyl Ketone	108-10-1	50	1.55	0.0196	2325	0.0335
N-Butyl Acetate	123-86-4	65	2.015	0.2541	3022.5	0.0435
1-Butanol	71-36-3	5	0.155	0.0196	232.5	0.0033
Propylene Glycol Methyl Ether Acetate	108-65-6	20	0.62	0.0782	930	0.0134
Propylene Glycol Methyl Ether ⁽¹⁾	107-98-2	20	0.62	0.0782	930	0.0134

Ethylene Glycol Butyl Ether	111-76-2	5	0.155	0.0196	232.5	0.0034
Stoddard Solvent	8052-41-3	5	0.155	0.0196	232.5	0.0034
Mineral Spirits	64742-49-0	5	0.155	0.0196	232.5	0.0034
Copper Phthalocyanine	1328-53-6	5	0.155	0.0196	232.5	0.0034
Copper Phthalocyanine Blue	147-14-8	10	0.31	0.0391	465	0.0067
Ethylene Glycol Butyl Ether Acetate	112-07-2	10	0.31	0.0391	465	0.0067
1,3,5-Trimethylbenzene	108-67-8	5	0.155	0.0196	232.5	0.0034
Isobutanol	78-83-1	5	0.155	0.0196	232.5	0.0034
Xylene	1330-20-7	25	0.775	0.0391	1162.5	0.0167
Solvent Naphtha, Light Aromatic	64742-95-6	10	0.31	0.0391	465	0.0067
Ethyl 3-Ethoxypropionate	763-69-9	10	0.31	0.0391	465	0.0067
Ethylbenzene	100-41-4	10	0.31	0.0391	465	0.0067
1,2,4-Trimethylbenzene	95-63-6	10	0.31	0.0391	465	0.0067
Methyl Acetate	79-20-9	5	0.155	0.0196	232.5	0.0034
Butyl Benzyl Phthalate	85-68-7	5	0.155	0.0196	232.5	0.0034
Isopropylbenzene	98-82-8	5	0.155	0.0196	232.5	0.0034
Dom's Auto Body, Xclusive Auto Collision, Platinum Auto Work (from each facility)						
Acetone	67-64-1	43%	1.33E+00	1.68E-01	2495.4	3.59E-02
Aromatic Petroleum Distillate	64742-94-5	10%	3.10E-01	3.91E-02	580.3	8.35E-03
Butane	106-97-8	11%	3.41E-01	4.30E-02	638.4	9.18E-03
Ethanol	64-17-5	2%	6.20E-02	7.81E-03	116.1	1.67E-03
Ethyl 3-Ethoxypropionate	763-69-9	9%	2.79E-01	3.52E-02	522.3	7.51E-03
Ethylbenzene	100-41-4	5%	1.55E-01	1.95E-02	290.2	4.17E-03
Methyl Ethyl Ketone	78-93-3	8%	2.48E-01	3.12E-02	464.3	6.68E-03
N-Butyl Acetate	123-86-4	5%	1.55E-01	1.95E-02	290.2	4.17E-03
Propane	74-98-6	11%	3.41E-01	4.30E-02	638.4	9.18E-03
Stoddard Solvent	8052-41-3	10%	3.10E-01	3.91E-02	580.3	8.35E-03
Toluene	108-88-3	10%	3.10E-01	3.91E-02	580.3	8.35E-03
Xylene	1330-20-7	10%	3.10E-01	3.91E-02	580.3	8.35E-03

1. SGC/AGC referenced compound

Table 17-13 shows the ingredients that make up the A&A Auto Body particulate group along with their Chemical Abstract Service (CAS) number by percent weight, and the hourly and annual emission rates calculated as the percent of the total particulate.

Table 17-13. Contaminants Identified as Particulate Short-term and Annual Emission Rates from the A&A Auto Body Spray Booth Operation.

Contaminant name	CAS No.	Percent Weight	1-Hour		Annual	
			lb/hr	g/s	lb/yr	g/s
Titanium Dioxide	1317-80-2	5	0.00325	4.10E-04	4.88	7.03E-05
Titanium Dioxide	13463-67-7	30	0.0195	2.46E-03	29.28	4.22E-04
C.I. Pigment Red	12656-85-8	30	0.0195	2.46E-03	29.28	4.22E-04
Mica	12001-26-2	10	0.0065	8.20E-04	9.76	1.41E-04

Graphite	7782-42-5	10	0.0065	8.20E-04	9.76	1.41E-04
Aluminum	7429-90-5	10	0.0065	8.20E-04	9.76	1.41E-04
Lead Sulfochromate Yellow	1344-37-2	0-30	0	0.00E+00	0	0.00E+00
Aluminum Oxide	1344-28-1	10	0.0065	8.20E-04	9.76	1.41E-04
Carbon Black	1333-86-4	5	0.00325	4.10E-04	4.88	7.03E-05
Iron Oxide Pigment	51274-00-1	10	0.0065	8.20E-04	9.76	1.41E-04
Bismuth Vanadium Oxide	14059-33-7	35	0.02275	2.87E-03	34.16	4.92E-04
Iron Oxide	1309-37-1	5	0.00325	4.10E-04	4.88	7.03E-05

Air Dispersion Analysis

AERMOD dispersion model version 16216r was used to estimate the impact on the Projected Development Sites. Generic one gram per second emission rate were initially modeled and the maximum impact concentration from each source were added, resulting in the cumulative impact. If a contaminant concentration exceeded the threshold standard, a cumulative analysis, specifying the pollutant emission rate, was conducted. As such, PM_{2.5}, both short-term and annual averaging times, and Ethyl 3-Ethoxypropionate 1-hour averaging time impacts were modeled as cumulative concentrations. If impact was still predicted, emission was specified during the work hours of 8:00-17:00. In accordance with CEQR guidance, this analysis was conducted assuming stack tip downwash, urban dispersion surface roughness length of 1.0-meter, elimination of calms, and with and without downwash effect on plume dispersion. In addition, the models specified elevated terrain and population of 1,700,000.

Due to the proximity of Projected Development Site 1 to the four auto body facilities, AERMOD models were run separately for Projected Development Site 1, Projected Development Site 5, and the other Projected Development Sites.

The stack parameters and building height of the A & A Auto Body facility were obtained from the DEP certificate PB0142002. The locations of the stacks of the other auto body facilities were confirmed in the fieldwork observation and site investigation. The roof height of DOM'S Auto Body was obtained from the NYC Open Data⁵⁵ web application. The roof height of Xclusive Auto Collision and Platinum Auto Work was observed to be the same height as A&A Auto Body's roof height. The stacks' parameters of the three auto body facilities operating with no permits applied the CEQR TM inputs of: diameter of 0 feet, 0.001 meter per second exit velocity, stack exit temperature of 293-degree Kelvin, and 3 feet height above the roof.

⁵⁵ <https://data.cityofnewyork.us/Housing-Development/Building-Footprints/nqwf-w8eh>

The U.S. Geological Survey (USGS) Digital Elevation Model (DEM) data: North American Datum of 1983, National Elevation Dataset (NED), 1/3 arc-second resolution digital elevation file was used to obtain pertinent difference in elevation. This DEM data file was obtained from Lakes Environmental through the AERMOD extension incorporated in the application. Per AERMOD user guide, the 1/3 arc-second resolution digital elevation is the preferred NED.

All analyses were conducted using the latest five consecutive years of meteorological data (2013-2017). Surface data was obtained from La Guardia Airport and upper air data was obtained from Brookhaven station, New York. Meteorological data were combined to develop a 5-year set of meteorological conditions, which was used for the AERMOD modeling runs and Anemometer height of 9.4 meters was specified per Lakes Environmental Software Inc. Per Lakes Environmental Inc., PM_{2.5} special procedure which is incorporated into AERMOD calculates concentrations at each receptor for each year modeled, averages those concentrations across the number of years of data, and then selects the highest values across all receptors of the 5-year averaged highest values.

As outlined in the *CEQR TM Air Pollutants and Applicable Standards/Guidelines* section, the predicted concentrations are compared with the maximum allowable concentration. If the predicted concentrations are below the allowable maximum concentrations, no significant adverse air quality impacts are expected. If impact is predicted, the impact's location is identified, and mitigation is specified. As previously mentioned, the predicted concentration of PM₁₀ was compared with the NAAQS, the PM_{2.5} concentration with the 24-hour and annual *de minimis*, and all other contaminants compared with the DAR-1 SGC/AGC threshold criterions.

The AERMOD dispersion analysis results of the 1-gram per second emissions are displayed in **Table 17-14**, where the reported values are the maximum impact concentrations of the with and without building wake effect on plum dispersion.

Table 17-14. AERMOD Maximum Generic 1-Gram per Second Modeled Concentrations.

Facility Name (DEP Permit ID)	Projected Development Site ID	1-Hour (µg/m ³)	24-Hour (µg/m ³)	Annual (µg/m ³)
A&A Auto Body (PB014002)	Site1	1,744	976	83
	Site 5	1,494	725	50
	Sites 2, 3, 4, 6	952	499	34
DOM'S Auto Body	Site1	7,527	1,178	208
	Site 5	2,854	367	42
	Sites 2, 3, 4, 6	2,181	298	45
Xclusive Auto Collision	Site1	6,158	1,487	185
	Site 5	4,911	730	97

	Sites 2, 3, 4, 6	3,225	710	86
Platinum Auto Work	Site1	6,202	1,498	187
	Site 5	4,721	757	95
	Sites 2, 3, 4, 6	2,955	663	83

Air Dispersion Results

The air dispersion analysis utilized AERMOD dispersion models. As previously outlined, separate analyses were conducted for Projected Development Site 1, Projected Development Site 5, and the other Projected Development Sites. PM₁₀ predicted concentration were compared with the NAAQS, and PM_{2.5} predicted concentrations compared with the NYC significant impact criteria. In addition, the PM_{2.5} 24-hour impact on Projected Development Site 1 was modeled with emission during work hours. The results of the criteria pollutants are displayed in **Table 17-15**.

Table 17-15. Criteria Pollutants Cumulative Dispersion Analysis Results.

Criteria Pollutant (Dispersion Model)	Threshold Standard	Predicted Concentration (µg/m ³)	Background Concentration (µg/m ³)	Evaluated Concentration (µg/m ³)	Threshold Criteria (µg/m ³)
Maximum Impact Concentration on Projected Development Site 1					
PM ₁₀ 24-Hour	NAAQS	19.7	37	56.7	150
PM _{2.5} 24-Hour	<i>de minimis</i>	1.63	N.A.	1.63	5.5
PM _{2.5} Annual	<i>de minimis</i>	0.19	N.A.	0.19	0.3
Maximum Impact Concentration on Projected Development Site 5					
PM ₁₀ 24-Hour	NAAQS	9.9	37	46.9	150
PM _{2.5} 24-Hour	<i>de minimis</i>	2.83	N.A.	2.83	5.5
PM _{2.5} Annual	<i>de minimis</i>	0.14	N.A.	0.14	0.3
Maximum Impact Concentration on Projected Development Site 2, 3, 4, and 6					
PM ₁₀ 24-Hour	NAAQS	8.3	37	45.3	150
PM _{2.5} 24-Hour	<i>de minimis</i>	5.1	N.A.	5.1	5.5
PM _{2.5} Annual	<i>de minimis</i>	0.12	N.A.	0.12	0.3

As displayed in **Table 17-15**, the PM₁₀ predicted concentration was compared with the NAAQS, and the PM_{2.5} 24-hour and annual averaging times with the NYC Interim Guidelines. The criteria pollutant analysis shows that all the criteria pollutants are within the NAAQS and NYC Interim Guidelines.

The non-criteria pollutants impact concentrations were compared with the NYSDEC SGC/AGC guideline where applicable (some contaminants do not have guideline concentration). All the Ethyl 3-Ethoxypropionate 1-hour averaging time were modeled cumulatively with emission during work hours. The other pollutants and Ethyl 3-Ethoxypropionate annual averaging time maximum impact from each facility were

added to predict the cumulative impact. The results of the non-criteria pollutants analysis are displayed in Table 17-16.

Table 17-16. Non-Criteria Pollutants Dispersion Analysis Results.

Contaminant name	CAS No.	Site 1 (µg/m³)		Site 5 (µg/m³)		Site 2, 3, 4, 6		SGC (µg/m³)	AGC (µg/m³)
		1-hour	Annual	1-hour	Annual	1-hour	Annual		
Propylene Glycol Methyl Ether	107-98-2	136.4	1.10	116.8	0.7	74.4	0.5	36850.0	2000.0
Ethylbenzene	100-41-4	456.6	3.02	302.3	1.3	200.5	1.1		1000.0
Butane	106-97-8	854.4	5.32	536.5	2.1	359.2	2.0	238000.0	
Methyl Isobutyl Ketone	108-10-1	340.9	2.80	292.0	1.7	186.0	1.1	31000.0	3000.0
Methoxypropylacetate	108-65-6	136.4	1.10	116.8	0.7	74.4	0.5	55000.0	2000.0
Trimethylbenzene, 1, 3, 5	108-67-8	34.1	0.30	29.2	0.2	18.6	0.1		6.0
Toluene	108-88-3	776.7	4.84	487.7	2.0	326.6	1.8	37000.0	5000.0
Ethylene Glycol Butyl Ether	111-76-2	34.1	0.30	29.2	0.2	18.6	0.1	14000.0	1600.0
Ethylene Glycol Butyl Ether	112-07-2	68.2	0.60	58.4	0.3	37.2	0.2		310.0
Amorphous Precipitated Silica	112926-00-8	1.4	0.01	1.2	0.01	0.8	0.01	No CAS	No CAS
Mica	12001-26-2	1.4	0.01	1.2	0.01	0.8	0.01		7.1
N-Butyl Acetate	123-86-4	831.6	6.02	623.5	3.1	405.1	2.4	95000.0	17000.0
C.I. Pigment Red	12656-85-8	4.3	0.04	3.7	0.02	2.3	0.01		
Iron Oxide	1309-37-1	0.7	0.01	0.6	0.003	0.4	0.002		12.0
Titanium Dioxide	1317-80-2	0.7	0.01	0.6	0.003	0.4	0.002		
Copper Phthalocyanine	1328-53-6	34.1	0.30	29.2	0.2	18.6	0.1		
Xylene	1330-20-7	947.2	6.24	633.7	2.8	419.6	2.4	22000.0	100.0
Carbon Black	1333-86-4	0.7	0.01	0.6	0.003	0.4	0.002		7.0
Aluminum Oxide	1344-28-1	1.4	0.01	1.2	0.01	0.8	0.01		4.5
Lead Sulfochromate Yellow	1344-37-2	0.0	0.00	0.0	0.00	0.0	0.0		2.0E-05
Titanium Dioxide	13463-67-7	4.3	0.04	3.7	0.02	2.3	0.01		24.0
Bismuth Vanadium Oxide	14059-33-7	5.0	0.04	4.3	0.02	2.7	0.02		
C.I. Pigment Green	14302-13-7	68.2	0.60	58.4	0.3	37.2	0.2		
Copper Phthalocyanine Blue	147-14-8	68.2	0.60	58.4	0.3	37.2	0.2		
Copper Phthalocyanine	15680-42-9	0.7	0.01	0.6	0.003	0.4	0.002	No CAS	No CAS
Iron Oxide Pigment	51274-00-1	1.4	0.01	1.2	0.01	0.8	0.01		
Ethanol	64-17-5	155.3	0.97	97.5	0.4	65.3	0.4		45000.0
Mineral Spirits	64742-49-0	34.1	0.30	29.2	0.2	18.6	0.1		
Aromatic Petroleum Distillate	64742-94-5	536.2	3.29	295.9	1.1	200.6	1.1		100.0
Solvent Naphtha, Light Aromatic	64742-95-6	68.2	0.60	58.4	0.3	37.2	0.2		100.0
Acetone	67-64-1	3340.0	20.80	2097.1	8.4	1404.3	7.7	180000.0	30000.0
Melamine Formaldehyde Resin	68002-21-1	0.7	0.01	0.6	0.003	0.4	0.002	No CAS	No CAS
1-Butanol	71-36-3	34.1	0.30	29.2	0.2	18.6	0.1		1500.0
Aluminum	7429-90-5	1.4	0.01	1.2	0.01	0.8	0.01		2.4
Propane	74-98-6	854.4	5.32	536.5	2.1	359.2	2.0		43000.0
Ethyl 3-Ethoxypropionate	763-69-9	182.8	4.95	153.6	2.1	136.3	1.8	140.0	64.0
Graphite	7782-42-5	1.4	0.01	1.2	0.01	0.8	0.0		4.8

Isobutanol	78-83-1	34.1	0.30	29.2	0.2	18.6	0.1		360.0
Methyl Ethyl Ketone	78-93-3	621.4	3.87	390.2	1.6	261.3	1.4	13000.0	5000.0
Methyl Acetate	79-20-9	34.1	0.30	29.2	0.2	18.6	0.1	76000.0	1400.0

As seen in **Table 17-16**, all the pollutants predicted concentrations, except the 1-hour Ethyl 3-Ethoxypropionate, are below the NYSDEC SGC/AGC concentrations guidelines. The 1-hour Ethyl 3-Ethoxypropionate impacts were predicted to Projected Development Site 1 and 5, and no impact was predicted to the other Projected Development Sites. **Figure 17-3** shows the location where VOC short-term impacts were predicted on Projected Development Site 1 wall façade facing Blondell Avenue.

Figure 27-3. Locations of VOC Impacts as Modeled in AERMOD.

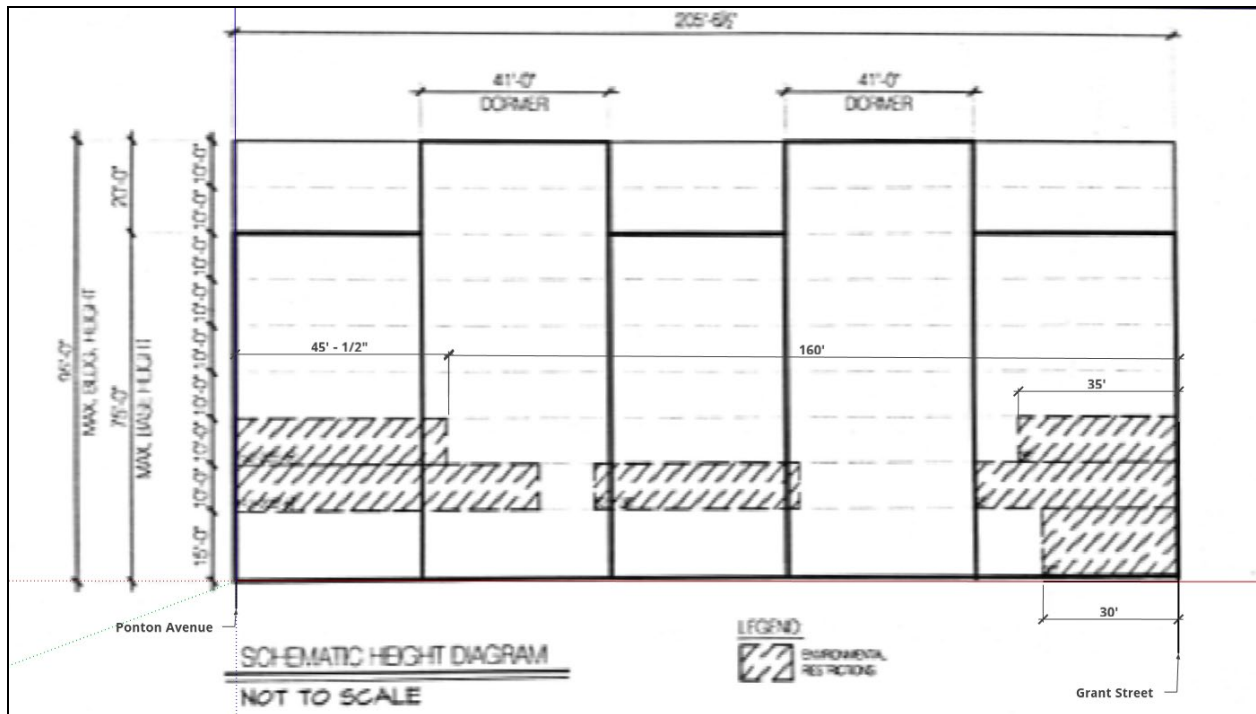

As impact was predicted, mitigation measures were incorporated.

Mitigation

Per *CEQR TM*, when a significant air quality impact is likely to result from a project, potential mitigation measures to eliminate such adverse impacts must be investigated. As the impact are a result of emission points not under the control of the Applicant, the mitigation measure considered alternative that can be applied to the planned for development properties (Projected Development Site 1 and Projected Development Site 5). As such, the one option is to modify the design of the proposed project to eliminate receptor locations that may experience impacts (building setbacks, sealed windows, etc.).

Impacts were predicted at the ground floor west corner of Projected Development Site 5, and at locations on the ground floor to third floor of Projected Development Site 1

wall façade facing Blondell Avenue as well as at the east corner of the building. These locations are specified in the E-Designation language, restricting the use of operable windows there.

(E) DESIGNATION

The (E) Designation requirements for Air Quality are as follows:

Block 4134, Lot 1 (Projected Development Site 1): Any new residential or commercial development on the above-referenced property must exclusively use natural gas as the type of fuel for heating, ventilating, air conditioning (HVAC) systems and ensure that the HVAC stack(s) is located at the highest tier and at least 98 feet above the grade to avoid any potential significant adverse air quality impacts.

To preclude the potential for significant adverse air quality impacts from the emissions sources located on Blondell Avenue (1341 Blondell Avenue [Block 4072, Lot 19], 1364 Blondell Avenue [Block 4072, Lot 19], and 1345 Blondell Avenue [Block 4072, Lot 19]), no operable windows or air intakes would be permitted on certain limited areas of the western and northern façades of any new residential development located on Block 4134, Lot 1, as identified below:

Block 4134, Lot 1 (Projected Development Site 1): Blondell Avenue Façade	
Grade Level:	Restriction Location:
Ground Floor (0-15 feet above grade)	0-30 feet measuring from the southeast lot line.
Second Floor (15-25 feet above grade)	Measuring from the southeast lot line: <ul style="list-style-type: none"> • 0-45 feet; • 83-128 feet; and • 140-206 feet.
Third Floor (25-35 feet above grade)	Measuring from the southeast lot line: <ul style="list-style-type: none"> • 0-35 feet; and • 160-206 feet.
Block 4134, Lot 1 (Projected Development Site 1): Ponton Avenue Façade	
Grade Level:	Restriction Location:
Second Floor (15-25 feet above grade)	0-15 feet measuring from the lot line facing Blondell Avenue.

Third Floor (25 to 35 feet above grade)	0-15 feet measuring form the lot line facing Blondell Avenue.
---	---

Block 4133, Lot 1 (Projected Development Site 2): Any new residential or commercial development on the above-referenced property must exclusively use natural gas as the type of fuel for heating, ventilating, air conditioning (HVAC) systems and ensure that the HVAC stack(s) is located at the highest tier and at least 98 feet above the grade and at least 55 feet from the lot line facing Cooper Avenue to avoid any potential significant adverse air quality impact.

Block 4133, Lot 2 (Projected Development Site 3): Any new residential or commercial development on the above-referenced property must exclusively use natural gas as the type of fuel for heating, ventilating, air conditioning (HVAC) systems and ensure that the HVAC stack(s) is located at the highest tier and at least 98 feet above the grade and at least 55 feet from the lot line facing Cooper Avenue to avoid any potential significant adverse air quality impact.

Block 4133, Lot 63 (Projected Development Site 4): Any new residential or commercial development on the above-referenced property must exclusively use natural gas as the type of fuel for heating, ventilating, air conditioning (HVAC) systems and ensure that the HVAC stack(s) is located at the highest tier and at least 98 feet above the grade and at least 20 feet from the lot line facing Cooper Avenue to avoid any potential significant adverse air quality impacts.

Block 4133, Lot 10 (Projected Development Site 5): Any new residential or commercial development on the above-referenced property must exclusively use natural gas as the type of fuel for heating, ventilating, air conditioning (HVAC) systems and ensure that the HVAC stack(s) is located at the highest tier and at least 98 feet above the grade and at least 55 feet from the lot line facing Cooper Avenue to avoid any potential significant adverse air quality impact.

To preclude the potential for significant adverse air quality impacts from the emissions sources located on Blondell Avenue (1341 Blondell Avenue [Block 4072, Lot 19], 1364 Blondell Avenue [Block 4072, Lot 19], and 1345 Blondell Avenue [Block 4072, Lot 19]), no operable windows or air intakes would be permitted on certain limited areas of the northern and western façades of any new residential development located on Block 4133, Lot 10, as identified in the table below.

Block 4133, Lot 10 (Projected Development Site 5): Blondell Avenue Façade	
Grade Level:	Restriction Location:
Ground Floor (0-15 feet above grade)	0-15 feet measuring from the northern lot line.
Second Floor (15-25 feet above grade)	Complete façade facing Blondell Avenue: from the northern lot line to the southern lot line.
Block 4133, Lot 10 (Projected Development Site 5): Northern Façade	
Grade Level:	Restriction Location:
Second Floor (15-25 feet above grade)	Measuring from the lot line facing Blondell Avenue: <ul style="list-style-type: none"> • 25-35 feet.

Block 4133, Lots 61 and 62 (Projected Development Site 6): Any new residential or commercial development on the above-referenced property must exclusively use natural gas as the type of fuel for heating, ventilating, air conditioning (HVAC) systems and ensure that the HVAC stack(s) is located at the highest tier and at least 98 feet above the grade and at least 20 feet from the lot line facing Cooper Avenue to avoid any potential significant adverse air quality impacts.

Conclusion

Air quality analyses addressed mobile sources, stationary HVAC systems, and air toxics. The results of the analyses are summarized below.

- Emissions from project-related vehicle trips would not cause significant adverse air quality impacts to receptors at the local or neighborhood scale;
- Emission from parking garages would not cause significant adverse air quality impacts to receptors at the local scale;
- As no existing large or major sources are located within 1,000 feet of the Affected Area, emissions from these types of existing stationary sources would not cause significant adverse air quality impact to the proposed project;
- No significant air quality impacts to the proposed project are anticipated from air toxics with (E)-Designation in place;

- Emissions from project-related heating, ventilation, and air conditioning systems (HVACs) would not cause significant adverse air quality impacts to receptors at the local scale with (E) - Designations in place.

19. NOISE

Introduction

Two types of potential noise impacts are considered under CEQR. These are potential mobile source and stationary source noise impacts. Mobile source impacts are those which could result from a proposed project adding a substantial amount of vehicular traffic to an area, or introducing new noise-sensitive land uses into an area where vehicular traffic creates high ambient noise levels. Potential stationary source noise impacts are considered when a proposed development would cause a stationary noise source to be operating within 1,500 feet of a sensitive land use (receptor), with a direct line of sight to that receptor, if the project would include unenclosed mechanical equipment for building ventilation purposes, or if the project would introduce a sensitive land use into an area with high ambient noise levels.

Noise Analysis

Subject Site

The Proposed Actions would allow for new residential development in an area generally east of Blondell Avenue and north of Westchester Avenue in the Bronx, New York. Vehicular traffic and elevated train movements are the predominant source of noise, and therefore the proposed development warrants an assessment of the potential for adverse effects on project occupants from ambient noise. The proposed development would not create a significant stationary noise generator. Additionally, project-generated traffic would not double vehicular traffic on nearby roadways, and therefore would not result in a perceptible increase in vehicular noise. This noise assessment is limited to an assessment of ambient noise that could adversely affect occupants of the development.

Blondell Avenue is a two-way north and south bound street with the intersections controlled by stop signs, except at its intersection with Westchester Avenue. Westchester Avenue is a two-way four lane road controlled by traffic lights. An elevated subway line operates over Westchester Avenue, directly adjacent to the Affected Area to the south, and a subway rail yard is located to the east. The area in which the Affected Area is located is primarily mixed residential, industrial, and commercial. The Affected Area currently primarily consists of multiple commercial buildings and open uses.

Framework of Noise Analysis

Noise is defined as any unwanted sound, and sound is defined as any pressure variation that the human ear can detect. Humans can detect a large range of sound pressures, from 20 to 20 million micropascals, but only those air pressure variations occurring within a particular set of frequencies are experienced as sound. Air pressure

changes that occur between 20 and 20,000 times a second, stated as units of Hertz (Hz), are registered as sound.

Because the human ear can detect such a wide range of sound pressures, sound pressure is converted to sound pressure level (SPL), which is measured in units called decibels (dB). The decibel is a relative measure of the sound pressure with respect to a standardized reference quantity. Because the dB scale is logarithmic, a relative increase of 10 dB represents a sound pressure that is 10 times higher. However, humans do not perceive a 10-dB increase as 10 times louder. Instead, they perceive it as twice as loud. The following Table Noise-1 lists some noise levels for typical daily activities.

Table Noise-1: Noise Levels of Common Sources

Table 19-1 Noise Levels of Common Sources	
Sound Source	SPL (dB(A))
Air Raid Siren at 50 feet	120
Maximum Levels at Rock Concerts (Rear Seats)	110
On Platform by Passing Subway Train	100
On Sidewalk by Passing Heavy Truck or Bus	90
On Sidewalk by Typical Highway	80
On Sidewalk by Passing Automobiles with Mufflers	70
Typical Urban Area	60-70
Typical Suburban Area	50-60
Quiet Suburban Area at Night	40-50
Typical Rural Area at Night	30-40
Isolated Broadcast Studio	20
Audiometric (Hearing Testing) Booth	10
Threshold of Hearing	0
<p><i>Notes: A change in 3dB(A) is a just noticeable change in SPL. A change in 10 dB(A) is perceived as a doubling or halving in SPL.</i></p> <p><i>Source: 2014 CEQR Technical Manual</i></p>	

Sound is often measured and described in terms of its overall energy, taking all frequencies into account. However, the human hearing process is not the same at all frequencies. Humans are less sensitive to low frequencies (less than 250 Hz) than mid-frequencies (500 Hz to 1,000 Hz) and are most sensitive to frequencies in the 1,000- to 5,000-Hz range. Therefore, noise measurements are often adjusted, or weighted, as a function of frequency to account for human perception and sensitivities. The most common weighting networks used are the A- and C-weighting networks. These weight scales were developed to allow sound level meters, which use filter networks to approximate the characteristic of the human hearing mechanism, to simulate the frequency sensitivity of human hearing. The A-weighted network is the most commonly used, and sound levels measured using this weighting are denoted as dBA. The letter "A" indicates that the sound has been filtered to reduce the strength of very low and very high frequency sounds, much as the human ear does. C-weighting gives nearly equal emphasis to sounds of most frequencies. Mid-range frequencies approximate the actual (unweighted) sound level, while the very low and very high frequency bands are significantly affected by C-weighting.

The following is typical of human response to relative changes in noise level:

- 3-dBA change is the threshold of change detectable by the human ear;
- 5-dBA change is readily noticeable; and
- 10-dBA change is perceived as a doubling or halving of the noise level.

The SPL that humans experience typically varies from moment to moment. Therefore, various descriptors are used to evaluate noise levels over time. Some typical descriptors are defined below.

- L_{eq} is the continuous equivalent sound level. The sound energy from the fluctuating SPLs is averaged over time to create a single number to describe the mean energy, or intensity, level. High noise levels during a measurement period will have a greater effect on the L_{eq} than low noise levels. L_{eq} has an advantage over other descriptors because L_{eq} values from various noise sources can be added and subtracted to determine cumulative noise levels.
- $L_{eq(24)}$ is the continuous equivalent sound level over a 24-hour time period.

The sound level exceeded during a given percentage of a measurement period is the percentile-exceeded sound level (L_x). Examples include L_{10} , L_{50} , and L_{90} . L_{10} is the A-weighted sound level that is exceeded 10% of the measurement period.

The decrease in sound level caused by the distance from any single noise source normally follows the inverse square law (i.e., the SPL changes in inverse proportion to

the square of the distance from the sound source). In a large open area with no obstructive or reflective surfaces, it is a general rule that at distances greater than 50 feet, the SPL from a point source of noise drops off at a rate of 6 dBA with each doubling of distance away from the source. For “line” sources, such as vehicles on a street, the SPL drops off at a rate of 3 dBA with each doubling of the distance from the source. Sound energy is absorbed in the air as a function of temperature, humidity, and the frequency of the sound. This attenuation can be up to 2 dB over 1,000 feet. The drop-off rate also will vary with both terrain conditions and the presence of obstructions in the sound propagation path.

Measurement Location and Equipment

Because the predominant noise sources in the area of the proposed project are vehicular and rail movements, noise monitoring was conducted during peak vehicular travel periods, 8:00-9:00 am, 12:00 pm-1:00 pm, and 5:00-6:00 pm. In addition, noise monitoring was conducted for a full 24 hours to ensure that the typical peak travel hours are in fact the worst-case condition for noise within the project area, which may also be affected by off-peak movements of trains within the rail yard located to the east. Pursuant to *CEQR Technical Manual* methodology, readings on all frontages were conducted for periods of one hour during each peak hour, due to the potential effects of rail noise. Noise monitoring was conducted using a Type 2 Larson-Davis LxT2 sound meter, with wind screen and a Type 1 Casella CEL-63X sound meter with wind screen. The monitors were placed on a tripod at a height of approximately three feet above the ground, away from any other noise-reflective surfaces. The monitors were calibrated prior to and following each monitoring session. Periods of peak vehicular and train traffic around the Affected Area constitute a worst-case condition for noise at the Project Site.

Figure 1: Noise Monitoring Locations



Legend

-  Noise Monitoring Location
-  Projected Development Sites
-  Proposed Development Sites

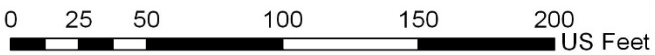

Photo 1: *Noise Monitoring Location One (1) at the Intersection of Blondell Ave and Ponton Ave*



Photo 2: *Noise Monitoring Location Two (2) at the Intersection of Blondell Ave and Westchester Ave.*



Photo 3: *Noise Monitoring Location Three (3) at the East End of Fink Ave. Adjacent to Rail Yard*



Photo 4: *Noise Monitoring Location Four (4) at the Frontage of Westchester Ave.*



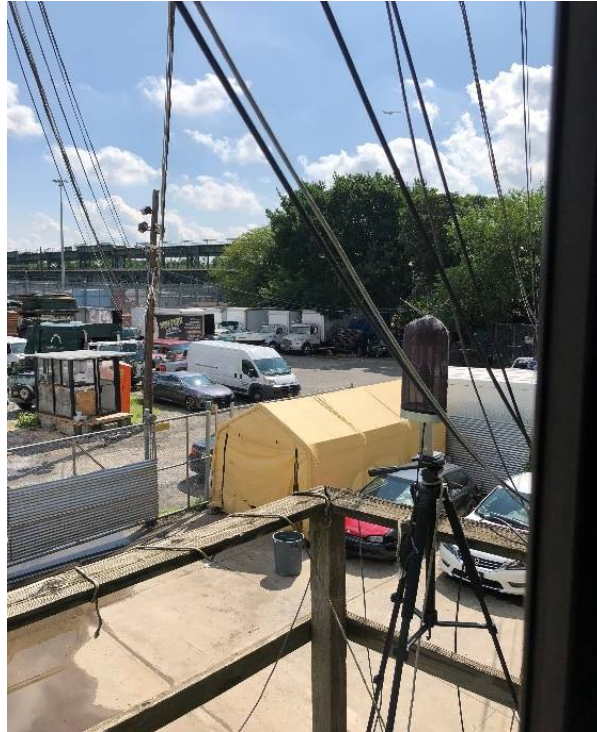

Photo 5: Noise Monitoring Location Five (5) at 2nd Floor Balcony Facing

Measurement Conditions

Monitoring was conducted during typical midweek conditions, on Tuesday, March 28, 2017, and Wednesday, March 29, 2017. In addition, 24-hour noise monitoring, was conducted on Tuesday, August 14, 2018 and Wednesday, August 15, 2018. The weather was dry and wind speeds were moderate during monitoring. Showers earlier in the morning on Tuesday March 28 had stopped by the time of the noise monitoring sessions, and there was no standing water on road surfaces. Neighboring properties were not a significant source of ambient noise. Traffic volumes and vehicle classification were documented during the noise monitoring. The sound meters were calibrated before and after each monitoring session.

Existing Conditions

Based on the noise measurements taken at the Project Site, the predominant source of noise at the Site is vehicular and train traffic. The volume of traffic, and its corresponding level of noise is moderate at locations 1, 3, and 5, and high at locations 2 and 4, in proximity to the elevated subway line. Table Noise-2 contains the results for the measurements taken at the Affected Area.

Table Noise-2 (1 of 4): Noise Levels at intersection of Blondell Avenue and Ponton Avenue, location 1

Tuesday, March 28, 2017			
Time	7:58 - 8:59 am	11:59 am - 12:59 pm	4:59 - 6:00 pm
L _{max}	88.6	84.3	90.1
L ₅	77.2	69.6	69.8
L₁₀	71.6	68.0	68.0
L _{eq}	69.1	64.9	66.2
L ₅₀	63.8	61.5	60.8
L ₉₀	57.0	58.2	57.1
L _{min}	53.1	55.9	54.5

Table Noise-2 (2 of 4): Noise Levels at Intersection of Blondell Avenue and Westchester Avenue, location 2

Tuesday, March 28, 2017			
Time	8:01 - 9:01 am	12:01 - 1:01 pm	4:59 - 6:00 pm
L _{max}	114.1	94.2	91.4
L ₅	87.0	84.0	82.5
L₁₀	81.9⁶	77.5	79.0
L _{eq}	81.9	76.3	75.6
L ₅₀	69.5	68.5	68.5
L ₉₀	65.0	64.0	62.0
L _{min}	58.3	59.9	58.9

Table Noise-2 (3 of 4): Noise Levels at eastern end of Fink Avenue, location 3

Wednesday, March 29, 2017			
Time	08:00 - 9:00 am	12:00 - 1:00 pm	5:00 - 6:00 pm
L _{max}	89.9	82.4	83.6
L ₅	76.7	72.9	74.8
L₁₀	69.4	67.3	68.4
L _{eq}	69.1	65.8	67.6
L ₅₀	62.9	56.3	60.7

⁶ Recorded L₁₀ at Location 2 during the AM period was 79.5. However, since a higher L_{eq} was recorded, the L_{eq} value of 81.9 is substituted for the L₁₀ value.

L ₉₀	61.4	53.2	58.8
L _{min}	56.4	51.1	56.0

Table Noise-2 (4 of 4): Noise Levels at frontage of Westchester Avenue, location 4

Tuesday, March 28, 2017			
Time	8:00 – 9:01 am	11:59 am – 1:03 pm	4:59 – 6:00 pm
L _{max}	90.8	89.8	91.4
L ₅	82.0	81.5	82.5
L₁₀	78.0	77.0	79.0
L _{eq}	75.3	74.0	75.6
L ₅₀	68.5	67.0	68.5
L ₉₀	61.5	61.0	62.0
L _{min}	57.2	57.8	58.7

Table Noise-2 (5 of 5): Noise Levels (dB)

Location 5: Noise Levels at the 2nd Floor Balcony Facing East Towards the Rail Yard

Start Date & Time	Leq	Lmin	L50	L95	Lmax	L10	L90
8/14/2018 11:04	59.5 dB	45.5 dB	53.0 dB	48.0 dB	79.5 dB	62.5 dB	48.5 dB
8/14/2018 12:04	63.0 dB	46.9 dB	59.0 dB	49.5 dB	87.4 dB	66.5 dB	50.5 dB
8/14/2018 13:04	63.3 dB	45.2 dB	56.5 dB	48.5 dB	86.1 dB	68.0 dB	49.5 dB
8/14/2018 14:04	63.0 dB	46.6 dB	56.5 dB	50.0 dB	89.6 dB	66.5 dB	52.0 dB
8/14/2018 15:04	74.2 dB	48.3 dB	64.5 dB	51.0 dB	101.0 dB	74.2⁷ dB	52.0 dB
8/14/2018 16:04	70.9 dB	49.4 dB	56.5 dB	51.5 dB	98.9 dB	72.0 dB	52.0 dB
8/14/2018 17:04	61.5 dB	48.7 dB	55.5 dB	51.0 dB	84.1 dB	64.5 dB	51.5 dB
8/14/2018 18:04	62.0 dB	47.6 dB	56.0 dB	50.0 dB	84.2 dB	65.0 dB	50.5 dB
8/14/2018 19:04	62.1 dB	47.3 dB	55.5 dB	49.5 dB	83.9 dB	66.5 dB	50.0 dB
8/14/2018 20:04	61.4 dB	46.6 dB	55.5 dB	49.0 dB	85.7 dB	65.5 dB	50.0 dB

⁷ The recorded L₁₀ during the hour beginning at 3:04 PM was 74.0. However, since the L_{eq} was higher than the L₁₀, the L_{eq} value, 74.2 dB, is substituted for the L₁₀ value.

8/14/2018 21:04	59.5 dB	45.9 dB	54.0 dB	48.5 dB	75.2 dB	64.0 dB	49.5 dB
8/14/2018 22:04	59.2 dB	46.0 dB	53.0 dB	48.5 dB	79.3 dB	62.5 dB	49.0 dB
8/14/2018 23:04	57.5 dB	45.2 dB	52.5 dB	47.5 dB	79.4 dB	60.5 dB	48.5 dB
8/15/2018 0:04	58.9 dB	45.5 dB	50.0 dB	47.5 dB	72.1 dB	65.0 dB	47.5 dB
8/15/2018 1:04	60.9 dB	46.7 dB	52.0 dB	49.0 dB	78.3 dB	65.0 dB	49.5 dB
8/15/2018 2:04	57.3 dB	45.9 dB	50.0 dB	48.0 dB	77.0 dB	58.5 dB	48.5 dB
8/15/2018 3:04	55.5 dB	44.9 dB	49.0 dB	46.5 dB	76.0 dB	52.5 dB	47.0 dB
8/15/2018 4:04	55.9 dB	45.6 dB	49.5 dB	47.5 dB	77.6 dB	56.0 dB	48.0 dB
8/15/2018 5:04	58.6 dB	47.7 dB	52.5 dB	50.0 dB	74.6 dB	62.5 dB	50.5 dB
8/15/2018 6:04	67.4 dB	51.5 dB	59.5 dB	53.5 dB	85.4 dB	72.0 dB	54.0 dB
8/15/2018 7:04	63.6 dB	51.0 dB	60.0 dB	53.0 dB	85.0 dB	67.5 dB	53.5 dB
8/15/2018 8:04	66.1 dB	51.7 dB	59.5 dB	53.5 dB	98.6 dB	67.5 dB	54.0 dB
8/15/2018 9:04	62.9 dB	50.8 dB	59.0 dB	52.5 dB	81.3 dB	66.0 dB	53.0 dB
8/15/2018 10:04	63.5 dB	48.9 dB	59.5 dB	51.5 dB	86.7 dB	66.5 dB	52.0 dB

Table Noise-3 (1 of 3):

Morning Traffic Volumes and Vehicle Classifications (vehicle counts for duration of the morning monitoring session)

	Location 1	Location 2	Location 3	Location 4
Car/ Taxi	202	667	633	674
Van/ Light Truck/SUV	241	552	482	324
Medium Truck	20	21	47	53
Heavy Truck	9	46	25	32
Bus	2	97	80	88
Train	16	16	15	16

Table Noise-3 (2 of 3):

Noon Traffic Volumes and Vehicle Classifications
(vehicle counts for duration of the noon monitoring session)

	Location 1	Location 2	Location 3	Location 4
Car/ Taxi	145	504	486	502
Van/ Light Truck/SUV	141	486	413	374
Medium Truck	18	46	31	54
Heavy Truck	15	29	21	27
Bus	1	50	40	49
Train	18	18	17	18

Table Noise-3 (3 of 3):

Evening Traffic Volumes and Vehicle Classifications
(vehicle counts for duration of the evening monitoring session)

	Location 1	Location 2	Location 3	Location 4
Car/ Taxi	152	490	502	574
Van/ Light Truck/SUV	143	472	449	459
Medium Truck	17	23	22	31
Heavy Truck	13	14	10	13
Bus	0	75	54	63
Train	15	14	14	15

Conclusions

The 2014 *CEQR Technical Manual* Table 19-2 contains noise exposure guidelines. For a residential use such as would occur under the Proposed Actions, an L₁₀ of between 65 and 70 dB(A) is identified as marginally acceptable general external exposure and an L₁₀ between 70 dB(A) and 80 dB(A) is identified as marginally unacceptable. The highest

recorded L_{10} at the location 1 of the Affected Area was 71.6 during the morning period. The highest recorded L_{10} at location 2 of the Affected Area was 79.5 during the morning period. However, the L_{eq} during this period was higher, 81.9, and therefore will be considered the worst-case noise level. The highest recorded L_{10} at location 3 of the Affected Area was 69.4 during the morning period. The highest recorded L_{10} at location 4 of the Affected Area was 79.0 during the evening period. The highest L_{10} at Location 5 of the affected area was 74.2 during the 3 to 4 pm period.

The 2014 *CEQR Technical Manual* Table 19-3 contains noise attenuation requirements to ensure acceptable indoor noise environment. Based on the results above, composite window-wall attenuation as identified below in Conclusions and Recommendations would be required to ensure an acceptable indoor noise level. With this level of noise attenuation, the proposed project does not have the potential for adverse impacts related to noise.

Conclusions and Recommendations

To avoid any potential impacts associated with noise, the Proposed Actions will place an (E) designation (E-?) for noise on the following properties. The text of the E-Designation would be as follows:

Block 4134, Lot 1 (Projected Development Site 1): To ensure an acceptable interior noise environment, future residential/ community facility/ commercial uses must provide a closed-window condition with a minimum of 28 dB(A) window/wall attenuation on all facades facing west (Blondell Avenue) and 31 dB(A) of attenuation on all other facades to maintain an interior noise level of 45 dB(A). To maintain a closed-window condition, an alternate means of ventilation must also be provided. Alternate means of ventilation includes, but is not limited to, air conditioning.

Block 4133, Lot 1 (Projected Development Site 2): In order to ensure an acceptable interior noise environment, future residential/ commercial uses must provide a closed-window condition with a minimum of 38 dB(A) window/wall attenuation on all building's facades in order to maintain an interior noise level of 45 dB(A). In order to maintain a closed-window condition, an alternate means of ventilation must also be provided. Alternate means of ventilation includes, but is not limited to, central air conditioning or air conditioning sleeves containing air conditioners.

Block 4133, Lot 2 (Projected Development Site 3): In order to ensure an acceptable interior noise environment, future residential/ commercial uses must provide a closed-window condition with a minimum of 38 dB(A) window/wall attenuation on all building's facades in order to maintain an interior noise level of 45 dB(A). In order to maintain a closed-window condition, an alternate means of ventilation must also be provided. Alternate means of ventilation includes, but is not limited to, central air conditioning or air conditioning sleeves containing air conditioners.

Block 4133, Lot 63 (Projected Development Site 4): In order to ensure an acceptable interior noise environment, future residential/commercial uses must provide a closed-window condition with a minimum of 38 dB(A) window/wall attenuation on all building's facades in order to maintain an interior noise level of 45 dB(A). In order to maintain a closed-window condition, an alternate means of ventilation must be provided. Alternate means of ventilation includes, but is not limited to, central air conditioning or air conditioning sleeves containing air conditioners.

Block 4133, Lot 10 (Projected Development Site 5): In order to ensure an acceptable interior noise environment, future residential/ commercial uses must provide a closed-window condition with a minimum of 28 dB(A) window/wall attenuation on all facades facing west (Blondell Avenue) and 31 dB(A) of attenuation on all other facades in order to maintain an interior noise level of 45 dB(A). To maintain a closed-window condition, an alternate means of ventilation must also be provided. Alternate means of ventilation includes, but is not limited to, air conditioning.

Block 4133, Lots 61 and 62 (Projected Development Site 6): In order to ensure an acceptable interior noise environment, future residential/ commercial uses must provide a closed-window condition with a minimum of 38 dB(A) on all building's facades in order to maintain an interior noise level of 45 dB(A). In order to maintain a closed-window condition, an alternate means of ventilation must be provided. Alternate means of ventilation includes, but is not limited to, central air conditioning or air conditioning sleeves containing air conditioners.

The owner of the Project Site will record the above-referenced (E) designation related to noise with the Mayor's Office of Environmental Remediation (OER) prior to the City Planning Commission's approval of the Proposed Actions.

With the implementation of the (E) designation, no significant adverse impacts related to noise would occur.

Therefore, the Actions would not result in any potentially significant adverse stationary or mobile source noise impacts, and further assessment is not warranted.

22. NEIGHBORHOOD CHARACTER

The project would not have the potential to result in any significant adverse impacts to the following analysis areas related to neighborhood character as further discussed below.

A. Land Use, Zoning, and Public Policy – As stated in the conclusion to this section above, the proposed action would not result in significant adverse impacts related to land use, zoning or public policy. Although the Land Use, Zoning, and Public Policy technical area of the EAS provides a detailed analysis, a neighborhood character assessment is not warranted as the project does not have the potential to result in any significant adverse Land Use, Zoning, or Public Policy impacts as further discussed below.

The rezoning area and the surrounding 400-foot radius project study area consist of a mixture of commercial retail and office uses; community facilities including houses of worship, libraries, schools, and a post office; an MTA NYC Transit train yard; manufacturing, warehouse, and automotive uses, such as repair shops; parking and vehicle storage lots; open space areas; and vacant parcels. As such, the proposed rezoning area and the project study area do not have a unified neighborhood character. The introduction of the proposed mixed-use residential, commercial, and community facility development as well as the mixed-use residential and commercial development anticipated on the Projected Development Sites would fit in well with the eclectic mix of uses in both the rezoning area and the surrounding project study area. The projected developments could alter existing development patterns in the future, especially of the underutilized parking and vehicle storage lots and vacant parcels, by encouraging the development of new residential and mixed-use projects. However, this would be in compliance with City policies to encourage the development of new housing, especially affordable housing, in underutilized areas of the City.

The proposed Zoning Map and Zoning Text Amendments would only apply to the Rezoning Area and would not affect lots beyond this area. The Applicant believes that the Proposed Actions would not result in any significant impacts to zoning patterns in the area since the mapping of the proposed R7A/C2-4 zoning district in the Rezoning Area would result in development that is believed to be compatible with the existing mixed neighborhood context while also providing enough floor area to develop affordable dwelling units on the Applicant Site and certain non-Applicant owned sites. The change in zoning is believed to be appropriate for this area as the proposed R7A/C2-4 zoning district would be similar to the R7-1 district mapped on a block just outside of the 400-foot radius project study area to the east as well as the C2-4 commercial overlays mapped within and just beyond 400 feet of the Rezoning Area along Westchester Avenue to the southwest. R6 zoning districts are also mapped within and just beyond 400 feet of the Rezoning Area to the south and west. The Applicant believes that the current M1-1 zoning is no longer appropriate for the project area given the lack of demand for manufacturing facilities in this area, which is very underdeveloped.

No impact to public policies would occur as a result of the Proposed Actions. The Applicant believes that the Proposed Actions would be an appropriate development in the Rezoning Area and would be a positive contribution to Bronx Community District 11 and to the surrounding neighborhood. The proposed project would meet the City's public policy goals as well as similar State and national public policy goals related to the provision of affordable housing. All development would comply with the provisions of the City's WRP applicable to the Coastal Zone area.

B. Socioeconomic Conditions - As stated in the conclusion to this section above, the Proposed Actions would not result in significant adverse impacts related to socioeconomic conditions. The Proposed Actions would not result in the direct or indirect displacement of residences or businesses in excess of the *CEQR Technical Manual* thresholds.

C. Open Space - As stated in the conclusion to this section above, the Proposed Actions would not result in significant adverse impacts related to open space. The Proposed Actions would not result in direct impacts on any open space resources and relative to indirect open space impacts, would result in a negligible decrease in the open space ratio in the future with action condition.

D. Historic and Cultural Resources - As stated in the conclusion to this section above, the proposed action would not result in any significant adverse impacts to historic or archaeological resources as LPC has determined that no such resources are located within the Rezoning Area or the surrounding 400-foot radius project study area.

E. Urban Design and Visual Resources - As stated in the conclusion to this section above, the proposed action would not result in a significant adverse impact to urban design and visual resources. Although the Urban Design and Visual Resources technical area of the EAS provides a detailed analysis, a neighborhood character assessment is not warranted as the project does not have the potential to result in any significant adverse Urban Design and Visual Resources impacts as further discussed below.

The Proposed Actions would result in the development of residential, commercial, and community facility uses and accessory parking on six Projected Development Sites located in an area characterized by a mixture of commercial and automotive related uses, parking, and vacant land.

The proposed R7A/C2-4 district was chosen for the Rezoning Area in order to develop residential uses on the Applicant's property which is not allowed under its current M1-1 zoning. It is also required to allow the proposed bulk of the new building to be increased from the current permitted FAR of 1.0 for manufacturing and commercial uses and 2.4 for community facility uses to 4.0 for all permitted residential and community facility uses (manufacturing uses would not be allowed), 2.0 for commercial uses, and 4.6 as a bonus for inclusionary housing. The increase in permitted bulk is appropriate given the City's policy of promoting increased development in close proximity to transit stops. The change is also appropriate given the lack of demand for manufacturing facilities in this area, which is very underdeveloped. The establishment of a Mandatory Inclusionary Housing area for

this application was developed in consultation with DCP in order to facilitate the development of affordable housing at a higher FAR in the area to be rezoned.

The proposed R7A zoning district is a contextual zoning district that requires development to be in accordance with Quality Housing standards. The district typically produces high lot coverage seven- and eight-story apartment buildings, blending with existing buildings in many established neighborhoods. R7A/C2-4 zoning was chosen for the Rezoning Area as an R7-1 district is mapped on a block bounded by Westchester Avenue, Waters Place, Waters Avenue, and Fink Avenue just outside of the 400-foot radius project study area to the east. R6 zoning districts are also mapped within and just beyond 400 feet of the Rezoning Area to the south and west. C2-4 commercial overlays are mapped within and just beyond 400 feet of the Rezoning Area along Westchester Avenue to the southwest.

The Proposed Actions include a change to the City Map that involves the elimination, discontinuance and closing of Fink Avenue between Blondell Avenue and Waters Avenue (Block 4133, part of Lot 8), and the adjustment of grades necessitated thereby, including authorization for any acquisition or disposition of real property related thereto (demap a mapped but unbuilt portion of Fink Avenue that traverses the Development Site). The portion of this street located within the Rezoning Area will be used for the development of the proposed mixed-use building on the Applicant's property.

The requested elimination of this portion of Fink Avenue makes ample sense given current conditions for several reasons: (1) The portion of the street in question is mapped, but unbuilt; (2) Given the location of an MTA NYC Transit train yard located to the east of the Development Site, it is highly unlikely the City will ever exercise its ability to build this portion of the street; (3) An application was approved to demap a parallel portion of Ponton Avenue (one block north) to a similar extent, further indicating that this portion of the originally proposed street network will not be built out (ULURP Application No.: 110342MMX; CEQR No.: 11DCP136X); and (4) the area that would theoretically benefit from the building of this portion of Fink Avenue is already accessible from the private streets known as Grant Street and Cooper Avenue, which predate the mapping of Fink Avenue.

The With-Action Development Scenario would not result in any significant impacts to the two open space visual resources (Owen F. Dolen Park and Samuel H. Young Park) located within the Rezoning Area. These open space areas are located some distance from the Projected Development Sites and are separated from them by intervening development and major streets. The Proposed Actions would not partially or totally block a view corridor or a natural or built visual resource that is rare in the area or considered a defining feature of the neighborhood. The Applicant believes that the development that would be facilitated by the rezoning would represent a visual improvement to the area and would result in new development on the underdeveloped Projected Development Sites that would be more compatible with the development pattern in residential areas further to the west. A detailed urban design analysis would not be required.

F. Shadows - As stated in the conclusion to this section above, the Proposed Actions would not result in any significant adverse shadows impacts. Buildings on Projected Development

Sites 1 through 6 would not cast any new shadows on shadow sensitive open space or historic resources. Therefore, the Proposed Actions would not result in any significant shadows impacts.

G. Transportation - As stated in the conclusion to this section above, no significant adverse impacts related to transportation would occur as a result of the Proposed Actions. The Proposed Actions would add vehicle trips to the study area. However, the traffic analysis shows that the Proposed Actions would not result in any significant adverse traffic impacts based on the impact criteria defined within the 2014 CEQR *Technical Manual*. It was determined that the number of new subway and bus trips generated by the Proposed Actions would not exceed the thresholds during any of the peak hours. The Proposed Actions would increase the level of vehicular activity at the immediate site vicinity intersection; however, the implementation of the City-wide reduction in speed limit in 2015 and elements of the engineering, planning, enforcement, and education action plan along Priority Corridors associated with Vision Zero are anticipated to improve safety in the site vicinity. Therefore, there are not anticipated to be safety-related significant adverse impacts associated with the proposed development.

H. Noise - The proposed action required a detailed noise analysis due to ambient noise levels in the vicinity of the Rezoning Area that could have a potentially adverse impact on future residents of the Projected Development Sites. As discussed in the noise section above, window-wall noise attenuation will be incorporated into the project design and therefore there would be no adverse impacts related to noise for project occupants. In order to avoid a significant adverse impact related to noise, E designations will be placed on Block 4134, Lot 1; Block 4133, Lot 1, 2, 10, 61/62, and 63. In addition, no potential significant adverse noise impacts would be generated by the proposed project on the surrounding area.

22. CONSTRUCTION

Introduction

A preliminary construction analysis may be required because future development facilitated by the Proposed Actions could result in the following. It should be noted that the proposed development on the Applicant Site, Projected Development Site 1, would not by itself result in any of the conditions below and would therefore not result in any construction impacts. However, development on Projected Development Site 1 in combination with projected development on the Non-Applicant Owned Sites 2 through 6 could result in potential construction impacts.

- Construction activities would occur along an arterial or major thoroughfare;
- Construction activities would occur on multiple development sites in the same geographic area, such that there is the potential for several construction timelines to overlap, and last for more than two years overall;
- The operation of several pieces of diesel equipment in a single location at peak construction; and
- The proposed development would involve construction of multiple buildings where there is a potential for on-site receptors on buildings to be completed before the final build-out.

Proposed Construction Schedule

Construction would occur on six Development Sites including one Applicant Owned Site and five Non-Applicant Owned parcels as further described below. Based on an estimated 12-month approval process and a 24-month construction period, the Build Year for the Applicant Controlled Site is assumed to be 2022. As the Proposed Actions would result in the creation of multiple Development Sites that are not controlled by the Applicant, it is anticipated that these Sites would be developed over a seven year period with a Build Year of 2029. The total construction period is therefore projected to be approximately 9 years for the six Projected Development Sites.

Applicant Owned Site

Construction of Projected Development Site 1 is expected to begin in 2020 and be completed within 2 years or less by the year 2022 as shown on the 1340 Blondell Avenue Construction Schedule.

Non-Applicant Owned Sites

It is not known when construction on the Non-Applicant Owned Sites would occur but it is assumed that it would occur following the completion of construction on the Applicant Owned Projected Development Site 1. It is assumed that construction on each of the Non-Applicant Owned Sites would occur sequentially starting at the Sites closest to the Applicant Owned Site. It is also assumed that there would be a six month gap between the completion of construction on each Site and the start of construction on the next Site. Due

to likely future market conditions in the Affected Area, it is likely that each building would need to be built and more or less fully occupied before construction of another nearby building would commence. Construction of each new building would take between 5.5 and 16 months to complete based on the square foot size of the structure. Therefore, assuming a total construction period of approximately 7 years on the Non-Applicant Owned Sites, the final project build year would be 2029.

The construction sequence and timeline for each of the Non-Applicant Owned Sites is listed below and illustrated on the attached construction schedule for each Development Site.

- Projected Development Site 5 – start construction June 2022; complete construction March 2023.

- Projected Development Site 3 – start construction September 2023; complete construction December 2024.

- Projected Development Site 4 – start construction June 2025; complete construction September 2026.

- Projected Development Site 2 – start construction March 2027; complete construction October 2027.

- Projected Development Site 6 – start construction April 2028; complete construction January 2029.

Proposed Construction Activities

Applicant Owned Site

Construction activities would begin with the demolition of the existing structures on Projected Development Site 1 (1 month). Following this, the major construction activities would include site preparation and excavation (2 months), construction of the building foundation (3 months), construction of the superstructure, joists, and roof (3 months), and interior fit-out work (15 months). Therefore, only 9 months would involve exterior construction activities on the proposed building with the remaining 15 months required for interior fit-out activities.

Non-Applicant Owned Sites

Construction activities on the Non-Applicant Owned Sites would be similar to those on the Applicant Owned Site described above. The anticipated timeframes on each Projected Development Site for demolition work, exterior construction work, and total time to construct each building is outlined below. Construction activities on each of the Non-Applicant Owned Sites would occur sequentially in the order listed below (starting at the Sites closest to the Applicant Owned Site). It is also assumed that there would be a six month gap between the completion of construction on each Site and the start of construction on the next Site.

- Projected Development Site 5 – demolition (1 month); 5 months exterior construction; 9 total months to construct building.
- Projected Development Site 3 – demolition (2 months); 5.5 months exterior construction; 16 total months to construct building.
- Projected Development Site 4 – demolition (2 months); 7.5 months exterior construction; 15 total months to construct building.
- Projected Development Site 2 – no demolition; 3.5 months exterior construction; 5.5 total months to construct building.
- Projected Development Site 6 – no demolition; 4 months exterior construction; 9 total months to construct building.

Project construction activities are expected to be typical for larger building construction projects in New York City. Construction activities would predominantly occur Monday through Friday, although limited delivery of certain critical pieces of equipment (e.g., cranes) may be necessary on weekend days if required in order to minimize traffic disruptions. Any weekend work would be contingent upon any conditions that may be imposed by City agencies that approve and monitor construction activities such as the NYC Department of Buildings (DOB) and the NYC Department of Transportation (DOT). DOB also regulates the permitted hours of construction. In accordance with those regulations, typical construction activities in New York City begin no earlier than 7 AM during the week, and workers typically arrive and begin to prepare work areas between 6 and 7 AM. The standard weekday construction work day ends by 3:30 PM with an occasional extended shift until 6 PM.

Potential Construction Impacts

In accordance with the 2014 *CEQR Technical Manual*, the proposed project was reviewed to determine whether further analysis of the proposed construction activities is needed for any technical area, as follows.

Transportation

According to the *CEQR Technical Manual*, a number of factors should be considered before determining whether a preliminary assessment of the effect of construction on transportation is needed including:

- *Whether the project's construction would be located in a Central Business District (CBD) or along an arterial or major thoroughfare;*
- *Whether the project's construction activities would require closing, narrowing, or otherwise impeding moving lanes, roadways, key pedestrian facilities, parking lanes and/or parking spaces, bicycle routes and facilities, bus lanes or routes, or access points to transit; and*
- *Whether the project would involve construction on multiple development sites in the same geographic area, such that there is the potential for several construction timelines to overlap, and last for more than two years overall.*

Two of the six projected buildings would be constructed along Westchester Avenue, a major thoroughfare (Projected Development Sites 2 and 6). Westchester Avenue is a two-way north-south roadway that operates with one to two travel lanes in each direction and curbside parking on both sides of the street. It is not anticipated that the construction on Projected Development Sites 2 and 6 would require the closing of any transportation elements adjacent to these Sites as access to these Sites can be obtained from Blondell Avenue and Fink Avenue onto Cooper Avenue which runs between them in the interior of the block. Cooper Avenue extends north from Westchester Avenue and is used as a driveway access to the adjoining parcels. Direct vehicular access to the Project Area either during construction or following completion of development would not be provided along Westchester Avenue.

It is not anticipated that the construction of the remaining Projected Development Sites, including Sites 1, 3, 4, and 5, would require the closing, narrowing, or otherwise impeding moving lanes, roadways, key pedestrian facilities, parking lanes and/or parking spaces, bicycle routes and facilities, bus lanes or routes, or access points to transit. Construction access to all these Development Sites can be obtained from Cooper and Fink Avenues/Grant Street which run between them in the interior of the block. As stated above, Cooper Avenue extends north from Westchester Avenue and is used as a driveway access to the adjoining parcels. The Grant Street portion of Fink Avenue is also used as a driveway access to the adjoining parcels. Construction access to Projected Development Site 1 can also be obtained from Ponton Avenue, a street to be demapped and used for parking that borders this Site to the north.

Blondell Avenue, which adjoins Projected Development Sites 1, 2, 3, and 5 to the west, is a local one-way roadway that operates with one travel lane in the northbound direction and curbside parking on both sides of the street. Although vehicular access to the Project Area would be provided along Blondell Avenue, construction vehicles would then enter the Project Area via the driveways and demapped streets noted above, and no changes to transportation elements along Blondell Avenue are anticipated.

Although the project would involve construction on multiple Development Sites in the same geographic area and is anticipated to last more than two years overall, it is not anticipated that the construction timelines would overlap as described in the proposed construction schedule above.

On the basis of the above, construction of the proposed project would not be expected to result in significant adverse impacts on transportation.

Air Quality and Noise

According to the *CEQR Technical Manual*, an assessment of air quality and noise for construction activities is likely not warranted if the project's construction activities:

- *Are considered short-term (less than two years);*
- *Are not located near sensitive receptors; and*

- *Do not involve construction of multiple buildings where there is a potential for on-site receptors on buildings to be completed before the final built-out.*

Construction of the proposed development on the Applicant Owned Projected Development Site 1 would be completed in two years or less. Although it is not known when construction on the Non-Applicant Owned Sites would occur, it is assumed that these Sites would be developed over a seven year period resulting in a total construction period of approximately nine years for the six Projected Development Sites.

The six Projected Development Sites are not located near sensitive receptors. The area in the immediate vicinity of the Rezoning Area is characterized primarily by commercial, manufacturing, transportation/utilities, and automotive/parking uses. The New York City Transit's (NYCT) 6-Train elevated subway line runs to the south of the Rezoning Area and a large NYCT Train Yard occupies the eastern portion of the project study area. Residential and other sensitive receptors are concentrated in the area to the west and northwest of the Rezoning Area and are separated from the Projected Development Sites by streets and intervening non-residential development. The closest Projected Development Site to these residential areas, Projected Development Site 1, is located approximately 240 feet to the northwest across Blondell and Ponton Avenues. Therefore, significant air quality and noise impacts to these areas from the projected development are not anticipated.

It is not known when construction on the Non-Applicant Owned Sites would actually occur. As discussed above, it is anticipated that construction on each of the Non-Applicant Owned Sites would occur sequentially starting at the Sites closest to the Applicant Owned Site and that there would be a six month gap between the completion of construction on each Site and the start of construction on the next Site. Therefore, the Proposed Actions could potentially result in the construction of multiple buildings where there is a potential for on-site receptors on buildings to be completed before the final build-out.

Any air quality and noise impacts from the construction on Projected Development Sites 2 through 6 on each other or on Projected Development Site 1 (which would complete construction before construction would start on any other Sites) would be mitigated by the relatively short periods of exterior construction activities that would occur on these Sites and the likelihood that exterior construction activities would be separated by periods of time where no such activities would occur. The exterior construction and demolition periods, would range from 3.5 to 9.5 months. No significant noise or air quality impacts would be anticipated from construction activities occurring within the interiors of the buildings.

The *CEQR Technical Manual* states that if a project meets one or more of the criteria above, a preliminary air quality or noise assessment is not automatically required. Instead, various factors should be considered, such as the types of construction equipment (*e.g.*, gas, diesel, electric), the nature and extent of any commitment to use the Best Available Technology (BAT) for construction equipment, the physical relationship of the Project Site to nearby sensitive receptors, the type of construction activity, and the duration of any heavy construction activity. These measures are discussed below.

Demolition, excavation, and foundation activities, which often generate the highest levels of air emissions, would be temporary and limited in duration and would take approximately 3.3 years (40.5 months) out of a total construction period of 9 years to complete. These activities would be spread out over six separate locations in the Rezoning Area and would not overlap as shown on the Construction Schedules. In addition, any heavy equipment associated with the construction of the buildings (such as a crane) would operate from at least six different locations during construction.

Air Quality

The project would make use of the Best Available Technology to minimize impacts to sensitive receptors in the vicinity of the Projected Development Sites as further discussed below.

As with most construction projects in the City, the proposed project would require the operation of several pieces of diesel equipment at one time during the heavier periods of construction, such as demolition and excavation. The Applicant would implement the following measures that would minimize air quality and noise impacts on the surrounding community.

- *Diesel Equipment Reduction.* Construction of the proposed project would minimize the use of diesel engines and use electric engines, to the extent practicable. This would reduce the need for on-site generators, and require the use of electric engines in lieu of diesel where practicable.
- *Clean Fuel.* To the extent practicable, ultra-low sulfur diesel (ULSD) would be used for diesel engines on the Projected Development Sites.
- *Best Available Tailpipe Reduction Technologies.* To the extent practicable, non-road diesel engines with a power rating of 50 horsepower (hp) or greater would utilize the best available tailpipe (BAT) technology for reducing diesel particulate matter (DPM) emissions. Diesel particle filters (DPF) have been identified as being the tailpipe technology currently proven to have the highest PM reduction capability.

To the extent practicable, construction contracts would specify that all diesel non-road engines rated at 50 hp or greater would utilize DPFs, either installed on the engine by the original equipment manufacturer (OEM) or retrofit with a DPF verified by EPA or the California Air Resources Board, and may include active DPFs if necessary; or other technology proven to reduce DPM by at least 90 percent.

- *Utilization of Newer Equipment.* EPA's Tier 1 through 4 standards for non-road engines regulate the emission of criteria pollutants from new engines, including PM, CO, NO_x, and hydrocarbons (HC). To the extent practicable, all non-road construction equipment in the project would meet at least the Tier 2 emissions standard, and construction equipment meeting Tier 3 and/or Tier 4 emissions standards would be used where conforming equipment is widely available, and the use of such equipment is practicable.

- *Dust Control.* Fugitive dust control plans will be implemented as part of the construction process. For example, stabilized truck exit areas would be established for washing off the wheels of all trucks that exit the construction sites. Truck routes within the Sites would be watered as needed to avoid the re-suspension of dust. All trucks hauling loose material will be equipped with tight fitting tailgates and their loads securely covered prior to leaving the Sites. In addition to regular cleaning by the City, streets adjacent to the Site would be cleaned as frequently as needed by the construction contractor. Water sprays will be used for all transfer of spoils to ensure that materials are dampened as necessary to avoid the suspension of dust into the air.
- *Restrictions on Vehicle Idling.* In addition to adhering to local laws restricting unnecessary idling on roadways, on-site vehicle idle time will also be restricted to three minutes, to the extent practicable, for all equipment and vehicles that are not using their engines to operate a loading, unloading, or a processing device (e.g., concrete mixing trucks) or otherwise required for the proper operation of the engine.

Overall, these air emission control commitments would significantly reduce DPM emissions to a level otherwise achieved by applying the currently defined best available control technologies under NYC Local Law 77, which are required only for publically funded City capital projects. In addition as stated in the *CEQR Technical Manual*, all the necessary measures would be implemented to ensure compliance with the NYC Air Pollution Control Code regulating construction-related dust emissions. Based on the project size and the construction work involved, construction activities for the proposed project would not be considered out of the ordinary or exceptional in terms of intensity. Therefore, based on above and with the implementation of an emissions control program, the proposed project would not result in any significant adverse impacts on air quality.

Noise

While increases in ambient noise levels due to construction exceeding the *CEQR* impact criteria for two years or less may be noisy and intrusive, they are not considered to be significant adverse noise impacts. As described above, demolition, excavation, and foundation activities, which are the noisiest construction activities, would be temporary and limited in duration and would take approximately 3.3 years (40.5 months) out of a total construction period of 9 years to complete. These activities would be spread out over six separate locations in the Rezoning Area and would not overlap. None of the Projected Development Sites would require exterior construction activities to occur in excess of approximately 9.5 months.

Construction noise is regulated by the NYC Noise Control Code and by EPA's noise emission standards for construction equipment. These local and federal requirements mandate that certain classifications of construction equipment and motor vehicles meet specified noise emission standards; that construction activities be limited to weekdays between the hours of 7 AM and 6 PM; and that construction materials be handled and transported in such a manner as not to create unnecessary noise. If weekend or after hour work is necessary, permits would be required to be obtained, as specified in the NYC Noise Control Code. In addition, the Applicant would commit to a preparing a noise control plan

that would be implemented during project construction. The measures to be contained in the plan would avoid noise impacts on the community. The plan would be prepared to be compliant with the NYC Noise Control Code (which requires a "Construction Noise Mitigation Plan") and would include such measures as construction noise source controls, path controls, and receiver controls. With these measures in place, no significant noise impacts are expected to occur as a result of the project construction.

Historic and Cultural Resources

No construction activities would occur within 400 feet of a historic resource as no such resources are located within this distance from the Affected Area. LPC has determined that no historic or archaeological resources are located within the Rezoning Area or the surrounding 400-foot radius project study area.

Hazardous Materials

As explained in the Hazardous Materials section above, the Phase I report conducted for Projected Development Site 1 has identified evidence of a Recognized Environmental Condition (REC) in connection with the Subject Property. The REC is for the storage yards at the Subject Property. The site reconnaissance, interviews, and review of records have found the presence or possible presence of hazardous substances or petroleum related products in, on, or at the Subject Property due to any release to the environment; under conditions indicative of a release to the environment; or under conditions that pose a material threat of a future release to the environment. Based on these current conditions, a vapor encroachment condition (VEC) is considered a concern with regard to the Subject Property.

It is not feasible to conduct subsurface testing at the present time on Projected Development Site 1, as this Site is currently in active use.

In lieu of a Phase II workplan, an "E" designation for hazardous materials will be placed on the zoning map pursuant to Section 11-15 of the New York City Zoning Resolution for the subject property. The "E" designation will ensure that testing and mitigation will be provided as necessary before any future development and/or soil disturbance on the property. The Applicant will be directed to coordinate further hazardous materials assessments through the Mayor's Office of Environmental Remediation.

Therefore, in order to avoid any potential impacts associated with hazardous materials, an (E) designation (E-505) will be assigned for hazardous materials on the following property:

Block 4134, Lot 1

The text for the (E) designations related to hazardous materials is as follows:

Task 1-Sampling Protocol

The applicant submits to OER, for review and approval, a Phase I of the site along with a soil, groundwater and soil vapor testing protocol, including a description of methods and a site map with all sampling locations clearly and precisely represented. If site sampling is necessary, no sampling should begin until written

approval of a protocol is received from OER. The number and location of samples should be selected to adequately characterize the site, specific sources of suspected contamination (i.e., petroleum based contamination and non-petroleum based contamination), and the remainder of the site's condition. The characterization should be complete enough to determine what remediation strategy (if any) is necessary after review of sampling data. Guidelines and criteria for selecting sampling locations and collecting samples are provided by OER upon request.

Task 2-Remediation Determination and Protocol

A written report with findings and a summary of the data must be submitted to OER after completion of the testing phase and laboratory analysis for review and approval. After receiving such results, a determination is made by OER if the results indicate that remediation is necessary. If OER determines that no remediation is necessary, written notice shall be given by OER.

If remediation is indicated from test results, a proposed remediation plan must be submitted to OER for review and approval. The applicant must complete such remediation as determined necessary by OER. The applicant should then provide proper documentation that the work has been satisfactorily completed.

A construction-related health and safety plan should be submitted to OER and would be implemented during excavation and construction activities to protect workers and the community from potentially significant adverse impacts associated with contaminated soil, groundwater and/or soil vapor. This plan would be submitted to OER prior to implementation.

With this (E) designation in place, no significant adverse construction impacts related to hazardous materials are expected, and no further analysis is warranted. Therefore, there is no potential for the Proposed Actions to result in significant adverse construction impacts related to hazardous materials on Projected Development Site 1.

Projected Development Sites 2 through 6

Projected Development Sites 2 through 6 are not under the control or ownership of the Applicant and it is therefore not feasible to conduct subsurface testing on these Projected Development Sites.

An "E" designation for hazardous materials will be placed on the zoning map pursuant to Section 11-15 of the New York City Zoning Resolution for the subject properties. The "E" designation will ensure that testing and mitigation will be provided as necessary before any future development and/or soil disturbance on these properties. These applicant(s) should be directed to coordinate further hazardous materials assessments through the Mayor's Office of Environmental Remediation.

Therefore, in order to avoid any potential impacts associated with hazardous materials, an (E) designation (E-505) will be assigned for hazardous materials on the following properties:

Block 4133, Lots 1, 2, 10, 61, 62, 63

The text for the (E) designations related to hazardous materials is as follows:

Task 1-Sampling Protocol

The Applicant submits to OER, for review and approval, a Phase I of the site along with a soil, groundwater and soil vapor testing protocol, including a description of methods and a site map with all sampling locations clearly and precisely represented. If site sampling is necessary, no sampling should begin until written approval of a protocol is received from OER. The number and location of samples should be selected to adequately characterize the site, specific sources of suspected contamination (i.e., petroleum based contamination and non-petroleum based contamination), and the remainder of the site's condition. The characterization should be complete enough to determine what remediation strategy (if any) is necessary after review of sampling data. Guidelines and criteria for selecting sampling locations and collecting samples are provided by OER upon request.

Task 2-Remediation Determination and Protocol

A written report with findings and a summary of the data must be submitted to OER after completion of the testing phase and laboratory analysis for review and approval. After receiving such results, a determination is made by OER if the results indicate that remediation is necessary. If OER determines that no remediation is necessary, written notice shall be given by OER.

If remediation is indicated from test results, a proposed remediation plan must be submitted to OER for review and approval. The Applicant must complete such remediation as determined necessary by OER. The Applicant should then provide proper documentation that the work has been satisfactorily completed.

A construction-related health and safety plan should be submitted to OER and would be implemented during excavation and construction activities to protect workers and the community from potentially significant adverse impacts associated with contaminated soil, groundwater and/or soil vapor. This plan would be submitted to OER prior to implementation.

With this (E) designation in place, no significant adverse construction impacts related to hazardous materials are expected, and no further analysis is warranted. Therefore, there is no potential for the Proposed Actions to result in significant adverse construction impacts related to hazardous materials on Projected Development Sites 2 through 6.

Natural Resources

According to the *CEQR Technical Manual*, a construction assessment is not needed for natural resources unless the construction activities would disturb a site or be located adjacent to a site containing natural resources. The Projected Development Sites and the adjacent properties are fully developed and do not contain any natural resources.

Therefore, there is no potential for significant adverse construction impacts on natural resources.

Open Space, Socioeconomic Conditions, Community Facilities, Land Use and Public Policy, Neighborhood Character, and Infrastructure

According to the *CEQR Technical Manual*, a preliminary construction assessment is generally not needed for these technical areas unless the following are true:

- *The construction activities are considered “long-term” (more than 2 years);*
- *Short-term construction activities would not directly affect a technical area, such as impeding the operation of a community facility.*

As discussed above, construction activities on the Applicant controlled parcel would be considered short term as they would occur over a period of 24 months or less. Although construction activities on the non-Applicant controlled parcels would extend the total construction period to more than two years (7 years), construction on these Sites would not have any significant direct effects on open space areas, socioeconomic conditions, community facilities, or infrastructure conditions, and would not have cumulative impacts on land use or neighborhood character. Therefore, construction of the proposed project would not be expected to result in any significant adverse construction impacts on these technical areas.

Conclusion

On the basis of the above analysis, the Proposed Actions would not have any potentially significant adverse construction impacts, and further analysis would not be warranted.

1340 Blondell Ave
Construction Schedule

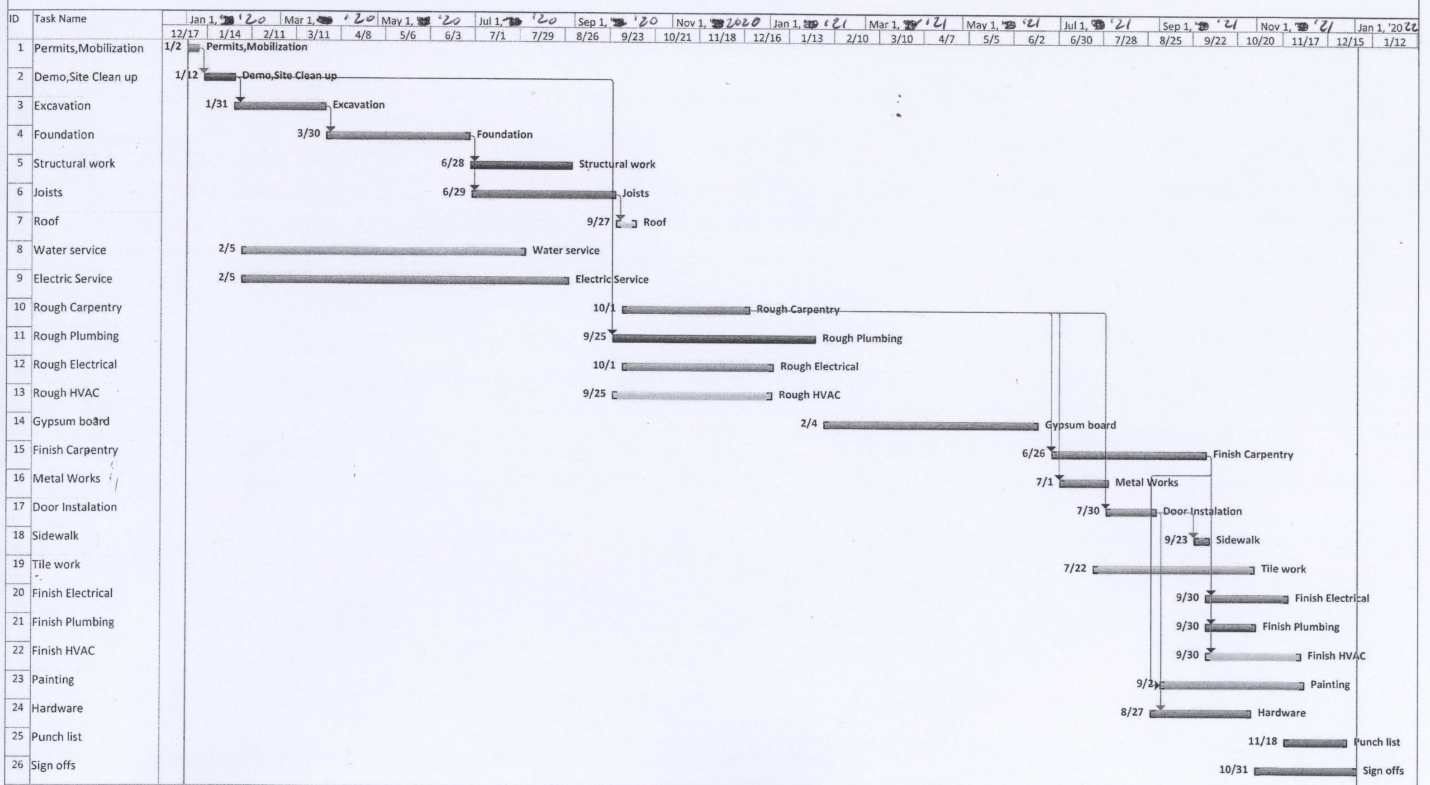

Blondell Ave Project site #5
Construction Schedule

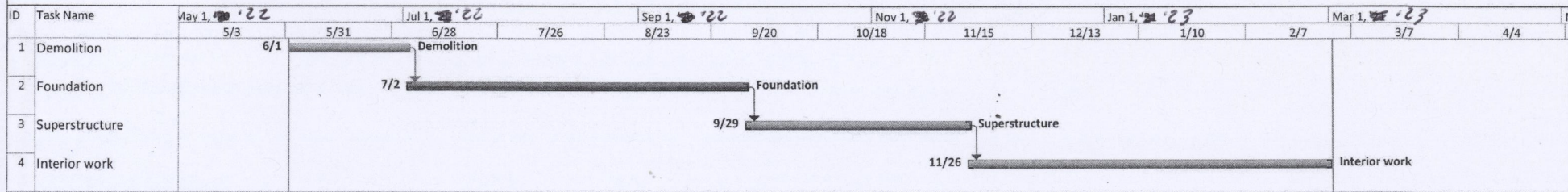

Blondell Ave Project site #3
Construction Schedule

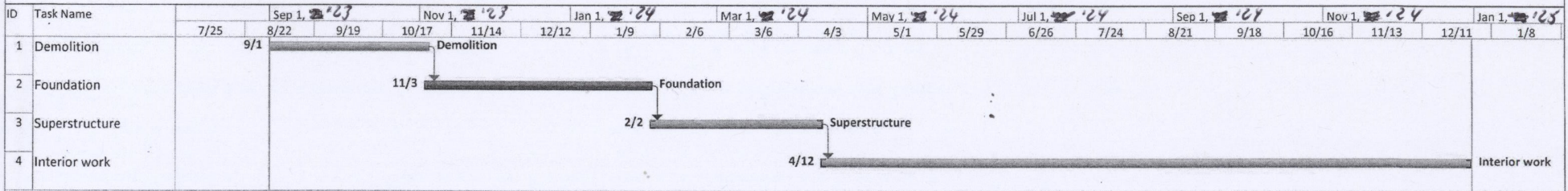

Blondell Ave Project site #4
Construction Schedule

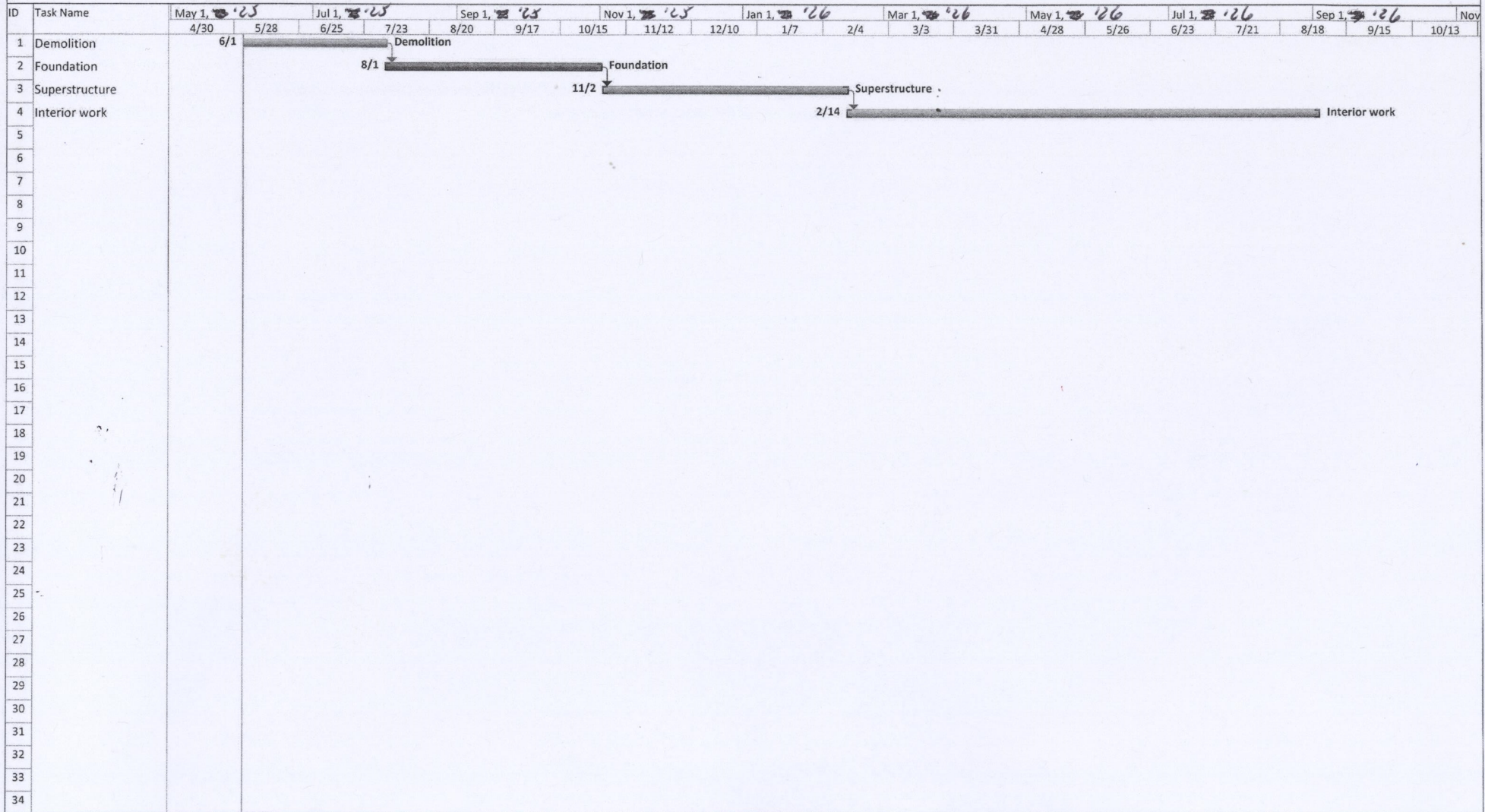

Blondell Ave Project site #2
Construction Schedule

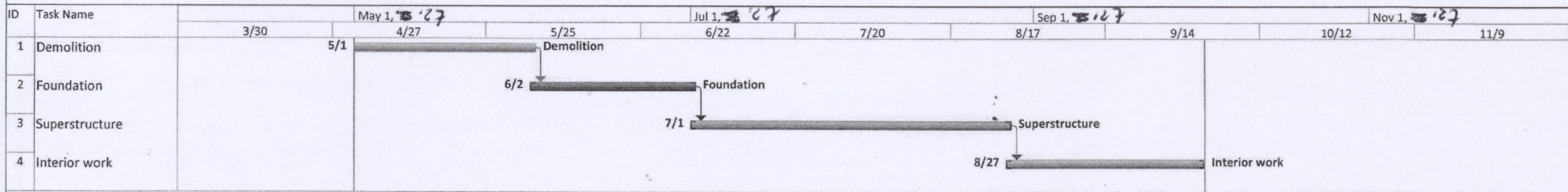

Blondell Ave Project site #6
Construction Schedule

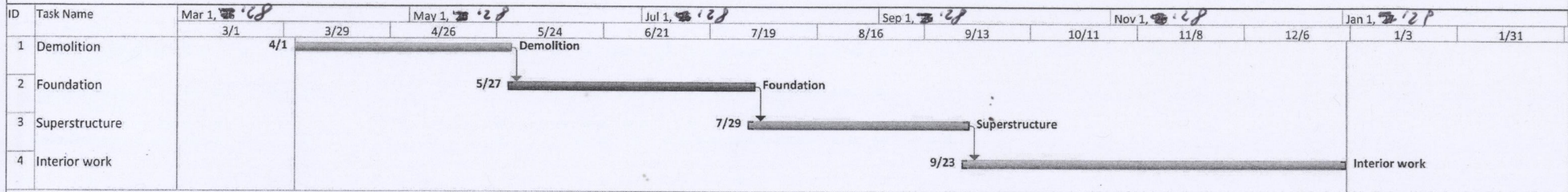

APPENDIX

Architectural Plans

FOR ILLUSTRATIVE
PURPOSE ONLY

1340
BLONDELL
AVE.
BRONX, NY

AUFGANG
ARCHITECTS

PROGRESS SET
09.24.18

PRELIMINARY
3D RENDERING

T-001.00

PROPOSED ZONE: R7A/C2-4
EX. ZONE: M1-1 09.24.18
BLOCK: 4133/4134 LOT: 1,2,4,62
63,70,12

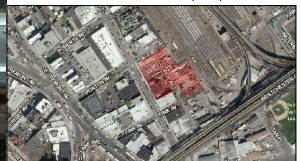

FOR ILLUSTRATIVE
PURPOSE ONLY

1340
BLONDELL
AVE.
BRONX, NY

Transit Zone Map 2



Transit Zone Map 2

AUFGANG
ARCHITECTS

PROGRESS SET
09.24.18

TRANSIT ZONE
MAP

T-002.00

SITE
OUT OF TRANSIT ZONE

PROPOSED ZONE: R7A/C2-4
EX. ZONE: M1-1 09.24.18
BLOCK: 4133/4134 LOT: 1,2,4,6,2
63,70,12

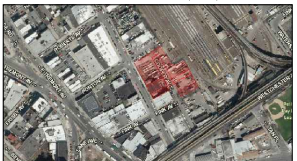



FINK AVE.



FEMA MAP

1340
BLONDELL
AVE.
BRONX, NY

AUFGANG
ARCHITECTS

PROGRESS SET
08.15.18



FINK AVE.



BLONDEL AVE.

TRANSIT ZONE
MAP

T-003.00

PROPOSED ZONE: R7A/C2-4
EX. ZONE: M1-1 08.15.18
BLOCK: 4133/4134 LOT: 1,2,4,62
63,70,12

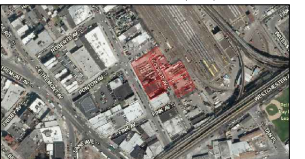

FOR ILLUSTRATIVE
PURPOSE ONLY

AUFGANG
ARCHITECTS

PROGRESS SET
09.24.18

ZONING LOT
SITE PLAN

C-100.00

PROPOSED ZONE: R7A/C2-4
EX. ZONE: M1-1 09.24.18
BLOCK: 4133/4134 LOT: 1,2,4,62
63.70.12

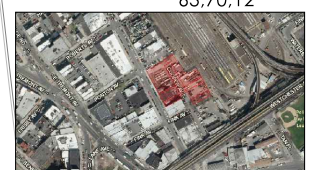

LEGEND:

← TRAFFIC DIRECTIONS	EXISTING CURB CUTS
— PROPERTY LINE	EXISTING TREE PIT
— MERGED ZONING LOT	⊕ FIRE HYDRANT
⊕ NEW STREET TREE	⊕ SIGNS
⊕ EXISTING STREET TREE	⊕ UTILITY LIGHT POLE
▒ PROPOSED DEVELOPMENT	⊕ MANHOLES
▒ EXISTING BUILDINGS	▒ GRATES

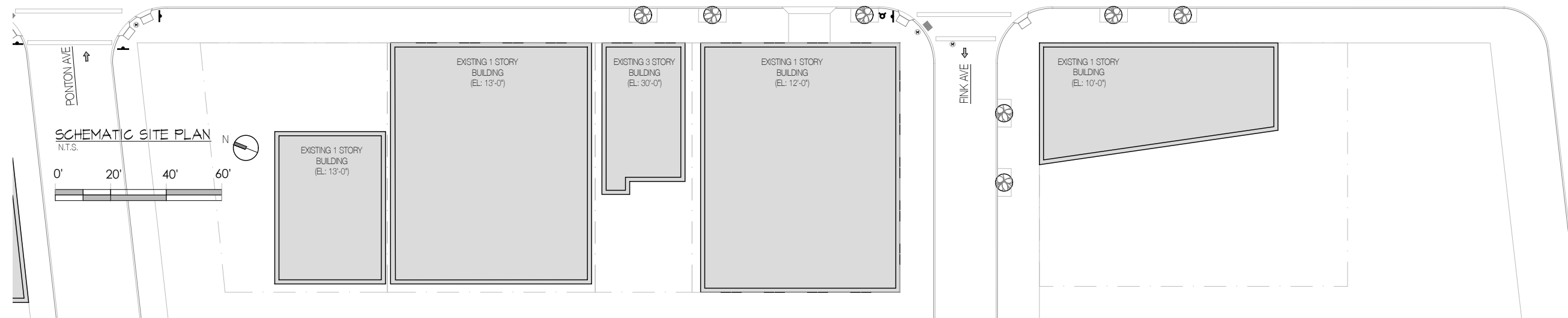

- LEGEND:**
- ← TRAFFIC DIRECTIONS
 - PROPERTY LINE
 - MERGED ZONING LOT
 - NEW STREET TREE
 - EXISTING STREET TREE
 - PROPOSED DEVELOPMENT
 - EXISTING BUILDINGS
 - ▭ EXISTING CURB CUTS
 - EXISTING TREE PIT
 - ⊙ FIRE HYDRANT
 - ⊙ SIGNS
 - ⊙ UTILITY LIGHT POLE
 - ⊙ MANHOLES
 - GRATES



PROGRESS SET
09.24.18

GENERIC
GROUND
FLOOR PLAN

C-101.00



FOR ILLUSTRATIVE
PURPOSE ONLY

1340
BLONDELL
AVE.
BRONX, NY

AUFGANG
ARCHITECTS

PROGRESS SET
09.24.18

ZONING
CALCULATIONS

Z-100.00

Site Data Block: 4134 & 4133 Lots: 1, 2, 4, 62, 63, 70/12 Address: 1340 Blondell Ave Existing Zoning: M1-1 Proposed Zoning: R7A/ C2-4 (M.I.H.) Community District: Bronx, 11 Zoning Section Map No.: 4b Zoning Lot Area: 46,360 sq.ft.	List of Required Actions 1. Rezone to R7A/C2-4(MIH)
---	---

ZR Section	Regulation	Permitted/Required	Proposed	Compliance Notes
RESIDENTIAL - USE GROUP 2				
22-10	Use Group	1, 2, 3, 4, 5, 6, 6c, 7, 8, 9, 14	2 & 6	Complies
23-32	Lot Area	1,700 sq.ft.	46,360 sq.ft.	Complies
23-153	Lot Coverage	30,134 sq.ft.	24,022 sq.ft.	Complies
23-153	F.A.R. Base	4.00		
23-154	F.A.R. Max.	4.6	4.13	Complies
33-121	F.A.R. (Commercial)	4.00	0.42	Complies
33-121	F.A.R. (Community Facility)	4.00	0.04	
23-154	F.A.R. (Mixed Dev. Use)	4.60	4.6	Complies
23-154	Residential Floor Area	213,256 sq.ft.	189,808 sq.ft.	Complies
33-121	Commercial Floor Area	92,720 sq.ft.	19,668 sq.ft.	Complies
33-121	Community Facility Floor Area	185,440 sq.ft.	2,024	
23-154	Mixed Use Dev. Floor Area	213,256 sq.ft.	211,500 sq.ft.	Complies
23-22	Density	307	228	Complies
23-662	Min Base Height	40'-0"	75'-0"	Complies
23-664	Max Base Height	75'-0"	75'-0"	Complies
23-664	Max Bldg. Height	90'-0"/9 Stories	95'-0"/9 Stories	Complies
23-45	Front Yard	N/A	N/A	Complies
23-462	Side Yard	N/A	N/A	Complies
23-47	Rear Yard	30'-0"	30'-0"	Complies
25-811	Bike Parking(Res)	114	114	Complies
36-711	Bike Parking(Comm)	2.2676	2	Complies
23-03	Street Tree	1 per 25' of frontage = 8 trees	5 on site 3 off site	Complies
	Parking			
36-20	Commercial	20	95	Complies
36-20	Community Facility	2	2	Complies
25-251	Residential	34	128	Complies
36-62	Loading Berth	None	None	Complies

PROPOSED ZONE: R7A/C2-4
EX. ZONE: M1-1 09.24.18
BLOCK: 4133/4134 LOT: 1,2,4,62
63,70,12



FOR ILLUSTRATIVE
PURPOSE ONLY

1340
BLONDELL
AVE.
BRONX, NY

AUFGANG
ARCHITECTS

Zoning Comparison Table				
Zoning Requirement	Permitted/Required			
	Existing M1-1		Proposed R7A/C2-4(MIH)	
	ZR Section(s)	M1-1	ZR Section(s)	R7A/C2-4 (MIH)
USE GROUPS	42-10	1, 2, 3, 4, 5, 6, 6c, 7, 8, 9, 14	22-10	2,4, & 6
FAR*				
Residential (Base)	N/A	N/A	23-154	4.00
Residential (Bonus)	N/A	N/A	23-154	4.60
Community Facility	43-122	2.40	33-121	4.00
Manufacturing	43-12	1.00	N/A	N/A
Commercial	43-12	1.00	33-121	4.00
YARDS				
Minimum Front Yard	N/A	NONE	23-45	NONE
Minimum Side Yard	43-25	NONE	23-462	NONE
Minimum Rear Yard	43-26	20'-0"	23-47	30'-0"
HEIGHT AND SETBACKS*				
Minimum Base Height	43-43	35'-0"/ 3 Stories	23-662	40'-0"
Maximum Base Height	43-43	35'-0"/ 3 Stories	23-664	75'-0"
Maximum Building Height	43-43	Slope of 1 To 1	23-664	95'-0"/9 Stories
Front Setback (Narrow Street)	43-43	20'-0"	23-662 (c)	15'-0"
Front Setback (Wide Street)	43-43	15'-0"	23-662 (c)	10'-0"
OPEN SPACE				
Residential				
Max. Interior Lot Coverage	N/A	N/A	N/A	N/A
LOT COVERAGE*				
Interior Lot	N/A	N/A	23-153	65%
DENSITY				
Affordable Dwelling Units	N/A	N/A	23-22	680 sf/DU max
PARKING				
Government Assisted Parking	N/A	N/A	25-251	15%
Community Facility	44-21	1 X 300	36-21	1 X 1000
Manufacturing	44-21	1 x 1000	N/A	N/A
Commercial	N/A	N/A	36-20	1 X 1000
LOADING				
	44-52	1 X 10000	36-20	N/A

*Residential Use Assumed Quality Housing Program

PROGRESS SET
09.24.18

ZONING
CALCULATIONS

Z-101.00

PROPOSED ZONE: R7A/C2-4
EX. ZONE: M1-1 09.24.18
BLOCK: 4133/4134 LOT: 1,2,4,62
63,70,12



ALL FIGURES ARE PRELIMINARY AND APPROXIMATE. LOT AREAS AND EXISTING FLOOR AREAS ARE SUBJECT TO SURVEY CONFIRMATION. FINAL AREAS AND LOT ANGLES TO BE VERIFIED BY COMPLETE SURVEY							
SITE DATA		LIST OF REQUIRED ACTIONS			QUALITY HOUSING PROGRAM		
Block:	4134 & 4133	1. REZONE TO R7A/C2-4 (M.I.H.)			CONST. CLASS 1-B 2HR RATED		
Lots:	1,2,4,62,63,70/12				BUILDING CODE OCCUPANCY GROUP R-2		
Street Address:	1340 BLONDELL AVE. BRONX, NY				BUILDING TO BE FULLY SPRINKLERED		
Existing Zoning:	M1-1				BUILDING TO BE DESIGNED		
Proposed Zoning:	R7A/C2-4(M.I.H.)				PER 2012 NYC BUILDING CODE		
Community District:	Bronx 11				PER NYC ENERGY CODE		
Zoning Section Map:	4b						
Zoning Lot Area	46,360.00						
ZR - Section	Title	Description	Permitted	Ex. to Remain	Proposed	Total	Compliance / Notes
22-10	USES	USE GROUP 1, 2, 3, 4, 5, 6, 6c, 7, 8, 9, 14			2, 4 & 6		OK
23-011	QUALITY HOUSING PROGRAM	R7A					OK
23-32	MIN LOT AREA	1,700 INTERIOR LOT 46,360 SQ. FT.					OK
23-154 , 33-121	FAR	RESIDENTIAL BASE 4.00 RESIDENTIAL BONUS 4.6 COMMERCIAL 2.0 COMM. FACILITY 4.00			4.1 0.4 0.04	4.6	OK OK OK OK
23-154, 33-121	FLOOR AREA	RESIDENTIAL (BASE) 46,360.00 X 4.00 = 185440.00 RESIDENTIAL (BONUS) 46,360.00 X 4.6 = 213256.00 COMMERCIAL 46,360.00 X 2.0 = 92720.00 COMM. FACILITY 46,360.00 X 4.00 = 185440.00					OK OK OK OK
23-154	TOTAL DEVELOPMENT	46,360.00 X 4.6 = 213256.00			211500		OK
23-153	LOT COVERAGE	INTERIOR LOT 65% = 30134.0			24022.0		OK
23-40 23-46 23-52	YARD REGULATION	FRONT YARD SIDE YARD REAR YARD	NONE NONE 30'-0"		NONE NONE 30'-0"		OK OK OK
33-27	SHALLOW INTERIOR LOTS	REAR YARD	N/A		N/A		OK
23-532 23-52		REQUIRED REAR YARD EQUIVALENT EXCEPTED THROUGH LOTS			N/A N/A		OK OK
23-662 23-664 26-664 23-692	HEIGHT & SETBACKS	MIN BASE MAX BASE MAX BUILDING HEIGHT LIMITATION FOR NARROW BLDGS. STREET WALL IS LESS THAN 45' IN WIDTH	40'-0" 75'-0" 90'-0"/9		75'-0" 75'-0" 95'-0"/9 N/A		OK OK OK R7-2, R7D, R7X, R8, R9 & R10
23-661	STREET WALL LOCATION	ENTIRE STREET FRONTAGE WITHIN 15' FROM STREET LINE			YES YES		OK OK
23-662 23-662	SETBACKS	SETBACK @ WIDE STREETS SETBACK @ NARROW STREETS	10'-0" 15'-0"		N/A 15'-0"		OK OK
23-62	PERMITTED OBS	PERMITTED OBSTRUCTIONS		DORMERS	DORMERS		OK
23-22	DENSITY	R7A 680	307		228		OK
23-84	OUTER COURT REG.	NARROW / WIDE OUTER COURT	YES		YES		OK
23-851	INNER COURT REG.	1,200 SQ. FT. (MIN) AND 30' MIN DIMENSION	N/A		N/A		OK
23-87	PERMITTED OBS IN COURTS	FENCE, OPEN TERRACES, SOLAR ENERGY SYSTEMS, ETC.	YES		YES		OK
23-693 23-52	SPECIAL PROVISIONS	ADJACENT TO R1 THROUGH R6B SHALLOW INTERIOR LOTS - LESS THAN 70' DEEP	N/A N/A		N/A N/A		OK OK
25-251 36-21 36-21	ACCESSORY OFF-STREET PARKING	RESIDENTIAL 15% COMM. FACILITY 1 X 1000 COMMERCIAL 1 X 1000	34 2 20		128 2 95	225	OK * OK OK
25-50	PARKING LOCATION	IN COURTS ON SITE	NO YES		NO YES		OK OK
36-711	BICYCLE PARKING	RESIDENTIAL 50% COMM. FACILITY 1E-04 COMMERCIAL 1E-04	114 1 2		114 1 2	117	OK OK OK
36-62	REQ. OFF-STREET LOADING BERTH	RESIDENTIAL NOT REQUIRED 0 COMMERCIAL MORE THAN 25,000 0	N/A N/A		N/A N/A		OK OK
36-683 36-684 36-685	LOADING BERTH REQ.	LOCATION - 60' FROM RESIDENTIAL DISTRICT BOUNDARY SURFACING - ASPHALT SCREENING - PLANTING STRIP OR WALL BARRIER	N/A N/A N/A		N/A N/A N/A		OK OK OK
225 PARKING SPACES PROVIDED			33727 PARKING AREA PROPOSED (CELLAR AND 1ST FLOOR RAMP)			150 SQ. FT. AVAILABLE PER CAR (ATT. PARKING)	

FOR ILLUSTRATIVE PURPOSE ONLY

1340
BLONDELL
AVE.
BRONX, NY

AUFGANG
ARCHITECTS

PROGRESS SET
09.24.18

ZONING
CALCULATIONS

Z-102.00

PROPOSED ZONE: R7A/C2-4
EX. ZONE: M1-1 09.24.18
BLOCK: 4133/4134 LOT: 1,2,4,62
63,70,12



FOR ILLUSTRATIVE
PURPOSE ONLY

1340
BLONDELL
AVE.
BRONX, NY

AUFGANG
ARCHITECTS

QUALITY HOUSING DEDUCTIONS										
FLOOR	GROSS	COMMERICAL	OCMM. FAC.	PARKING / LOADING	RESIDENTIAL	MECHANICAL	REC.	REFUSE	LAUNDRY	TOTAL ZONING RESIDENTIAL
	SQ. FT.	SQ. FT.	SQ. FT.	SQ. FT.	GROSS SQ. FT.	SQ. FT.	SQ. FT.	SQ. FT.	SQ. FT.	
C	39547			31989	7558					0
1	33631	19668	2024	1738	10201	466				9735
2	24022				24022	1175	3407	12		19428
3	24022				24022	50	2250	12	1157	20553
4	24022				24022	50		12		23960
5	24022				24022	50		12		23960
6	24022				24022	50		12		23960
7	24022				24022	50		12		23960
8	22175				22175	37		12		22126
9	22175				22175	37		12		22126
TOTAL	261660	19668	2024	33727	206241	1965	5657	96	1157	189808

PROGRESS SET
09.24.18

9/15/2016	OBR.	1BR.	2BR.	3BR.	TOTAL
1ST FLOOR	0	0	0	0	0
2ND FLOOR	6	10	8	5	29
3RD FLOOR	6	10	8	5	29
4TH FLOOR	6	10	8	5	29
5TH FLOOR	6	10	8	5	29
6TH FLOOR	6	10	8	5	29
7TH FLOOR	6	10	8	5	29
8TH FLOOR	6	10	6	5	27
9TH FLOOR	6	10	6	5	27
TOTAL	48	80	60	40	228
PERCENT	21%	35%	26%	18%	100%

APARTMENT DISTRIBUTION

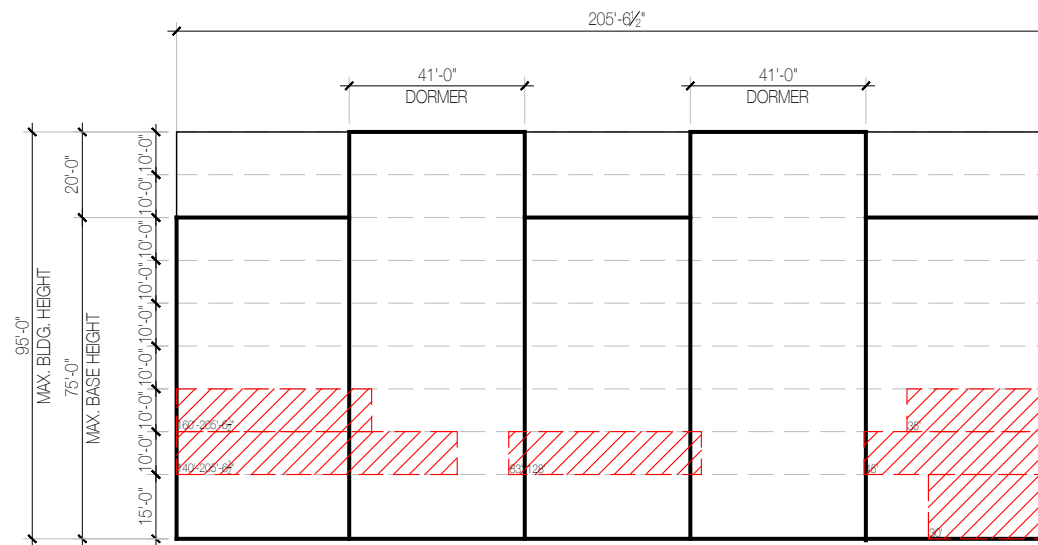

SCHMATIC HEIGHT DIAGRAM
NOT TO SCALE

LEGEND:
ENVIRONMENTAL RESTRICTIONS

ZONING
CALCULATIONS
& APT.
DISTRIBUTION

Z-103.00

PROPOSED ZONE: R7A/C2-4
EX. ZONE: M1-1 09.24.18
BLOCK: 4133/4134 LOT: 1,2,4,62
63,70,12

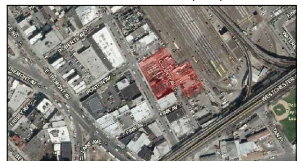

FOR ILLUSTRATIVE
PURPOSE ONLY

1340
BLONDELL
AVE.
BRONX, NY

AUFGANG
ARCHITECTS

PROGRESS SET
09.24.18

CELLAR PLAN

A-100.00

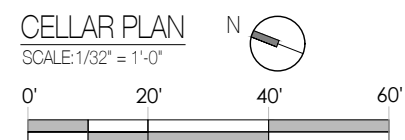

PROPOSED ZONE: R7A/C2-4
EX. ZONE: M1-1 09.24.18
BLOCK: 4133/4134 LOT: 1,2,4,62
63,70,12



FOR ILLUSTRATIVE
PURPOSE ONLY

1340
BLONDELL
AVE.
BRONX, NY

AUFGANG
ARCHITECTS

PROGRESS SET
09.24.18

FIRST FLOOR
PLAN

A-101.00



1ST FLOOR PLAN
SCALE: 1/32" = 1'-0"



PROPOSED ZONE: R7A/C2-4
EX. ZONE: M1-1 09.24.18
BLOCK: 4133/4134 LOT: 1,2,4,62
63.70.12



FOR ILLUSTRATIVE
PURPOSE ONLY

1340
BLONDELL
AVE.
BRONX, NY

AUFGANG
ARCHITECTS

PROGRESS SET
09.24.18

2ND FLOOR
PLAN

A-102.00



LEGEND:

- 0BR
- 1BR
- 2BR
- 3BR

2ND FLOOR PLAN

SCALE: 1/32" = 1'-0"



PROPOSED ZONE: R7A/C2-4
 EX. ZONE: M1-1 09.24.18
 BLOCK: 4133/4134 LOT: 1,2,4,62
 63.70.12



FOR ILLUSTRATIVE
PURPOSE ONLY

1340
BLONDELL
AVE.
BRONX, NY

AUFGANG
ARCHITECTS

PROGRESS SET
09.24.18



3RD FLOOR PLAN

SCALE: 1/32" = 1'-0"



3RD FLOOR
PLAN

A-103.00

PROPOSED ZONE: R7A/C2-4
EX. ZONE: M1-1 09.24.18
BLOCK: 4133/4134 LOT: 1,2,4,62
63,70,12



FOR ILLUSTRATIVE
PURPOSE ONLY

1340
BLONDELL
AVE.
BRONX, NY





AUFGANG
ARCHITECTS

PROGRESS SET
09.24.18

4TH THRU 7TH
FLOOR PLAN

A-104.00

LEGEND:

-  0BR
-  1BR
-  2BR
-  3BR



4TH THRU 7TH FLOOR PLAN

SCALE: 1/32" = 1'-0"



PROPOSED ZONE: R7A/C2-4
EX. ZONE: M1-1 09.24.18
BLOCK: 4133/4134 LOT: 1,2,4,62
63,70,12

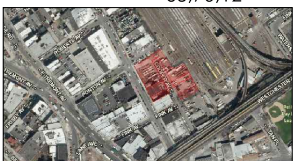

FOR ILLUSTRATIVE
PURPOSE ONLY

1340
BLONDELL
AVE.
BRONX, NY

AUFGANG
ARCHITECTS

PROGRESS SET
09.24.18

8TH & 9TH
FLOOR PLAN

A-105.00



FOR ILLUSTRATIVE
PURPOSE ONLY

1340
BLONDELL
AVE.
BRONX, NY

AUFGANG
ARCHITECTS

PROGRESS SET
09.24.18



SCHMATIC
ELEVATION

A-106.00

PROPOSED ZONE: R7A/C2-4
EX. ZONE: M1-1 09.24.18
BLOCK: 4133/4134 LOT: 1,2,4,62
63,70,12

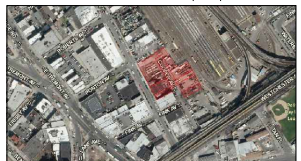

FOR ILLUSTRATIVE
PURPOSE ONLY

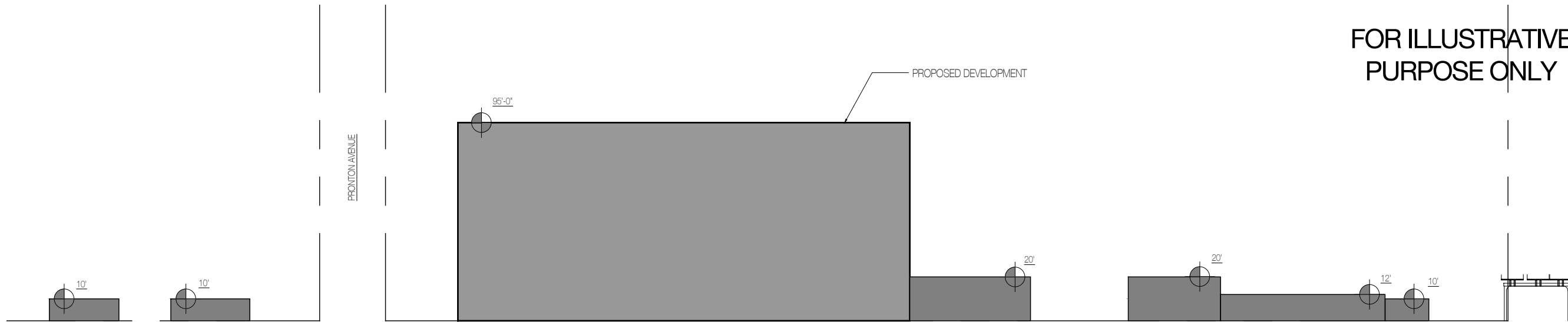

STREETSCAPE ELEVATION A-A
NOT TO SCALE

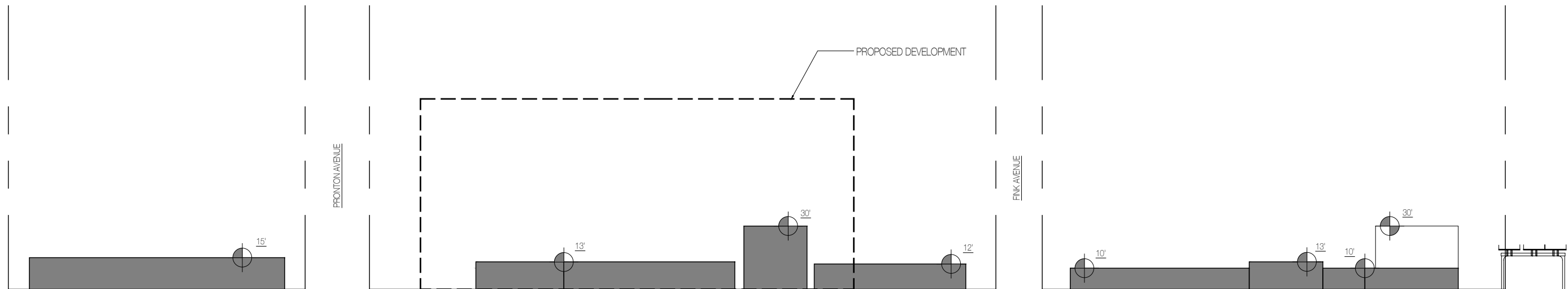

STREETSCAPE ELEVATION B-B
NOT TO SCALE

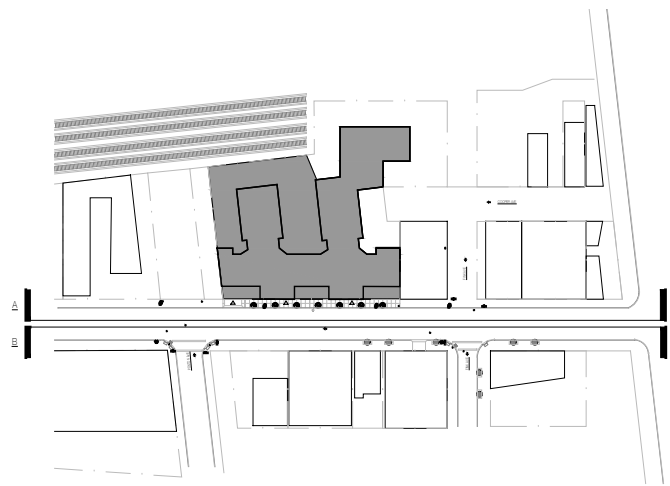

KEY PLAN
NOT TO SCALE

- LEGEND:**
- PROPOSED DEVELOPMENT
 - STREETS
 - PROPOSED DEVELOPMENT BEHIND
 - BUILDING HEIGHTS
 - EXISTING BUILDINGS ON ELEVATION STREETSCAPE
 - EXISTING BUILDINGS BEYOND STREET WALL

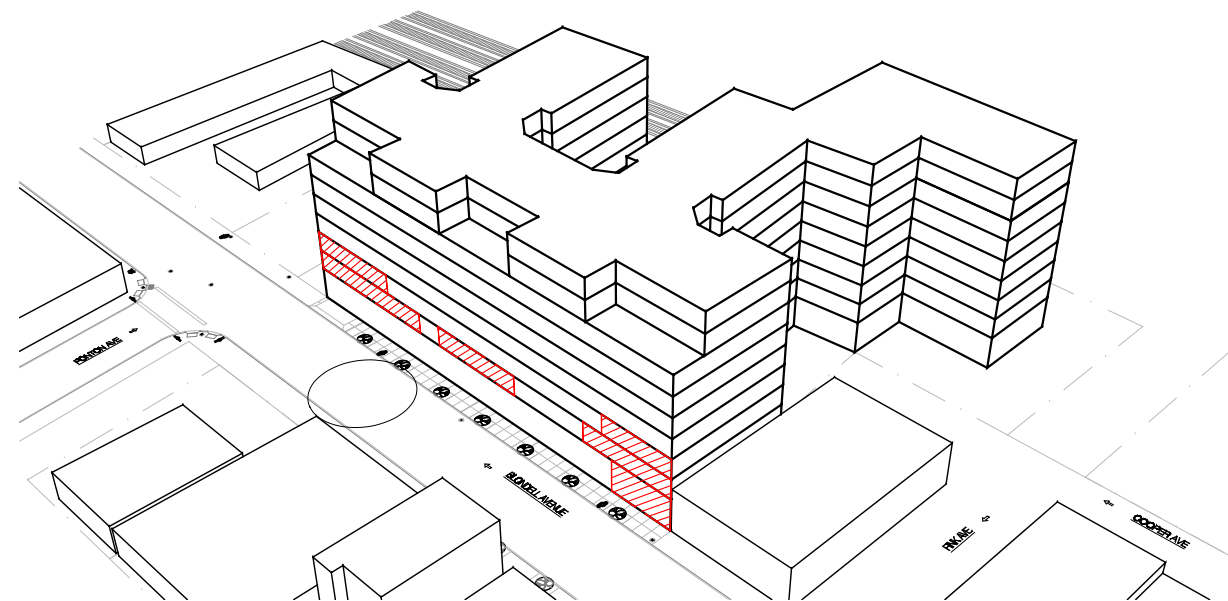

3D MASSING
NOT TO SCALE

PROGRESS SET
09.24.18

NEIGHBORHOOD
CHARACTER
DIAGRAM

A-107.00

PROPOSED ZONE: R7A/C2-4
EX. ZONE: M1-1 09.24.18
BLOCK: 4133/4134 LOT: 1,2,4,62
63.70.12

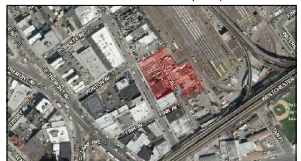

**WATERFRONT
REVITALIZATION PROGRAM
APPENDIX**

NYC Waterfront Revitalization Program - Policy 6.2 Flood Elevation Worksheet

COMPLETE INSTRUCTIONS ON HOW TO USE THIS WORKSHEET ARE PROVIDED IN THE "CLIMATE CHANGE ADAPTATION GUIDANCE" DOCUMENT AVAILABLE AT www.nyc.gov/wrp

Enter information about the project and site in highlighted cells in Tabs 1-3. HighTab 4 contains primary results. Tab 5, "Future Flood Level Projections" contains background computations. The remaining tabs contain additional results, to be used as relevant. Non-highlighted cells have been locked.

Background Information	
Project Name	Blondell Commons
Location	1340 Blondell Avenue, Bronx, NY 10461
Type(s)	<input checked="" type="checkbox"/> Residential, Commercial, Community Facility <input type="checkbox"/> Parkland, Open Space, and Natural Areas <input type="checkbox"/> Tidal Wetland Restoration <input type="checkbox"/> Critical Infrastructure or Facility <input type="checkbox"/> Industrial Uses <input type="checkbox"/> Over-water Structures <input type="checkbox"/> Shoreline Structures <input type="checkbox"/> Transportation <input type="checkbox"/> Wastewater Treatment/Drainage <input type="checkbox"/> Coastal Protection
Description	The proposed project is the development of a new nine-story and cellar, 95'-0" tall mixed-use building totaling 261,660 gsf and containing 228 dwelling units within 198,683 gsf on floors 1-9 (plus 7,558 gsf of cellar space). The development would also contain 19,668 gsf of retail space and 2,024 gsf of community facility space. The development would include 225 attended accessory parking spaces.
Planned Completion date	2020

The New York City Waterfront Revitalization Program Climate Change Adaptation Guidance document was developed by the NYC Department of City Planning. It is a guidance document only and is not intended to serve as a substitute for actual regulations. The City disclaims any liability for errors that may be contained herein and shall not be responsible for any damages, consequential or actual, arising out of or in connection with the use of this information. The City reserves the right to update or correct information in this guidance document at any time and without notice.

For technical assistance on using this worksheet, email wrp@planning.nyc.gov, using the message subject "Policy 6.2 Worksheet Error."

Last update: June 7, 2017

Establish current tidal and flood heights.

	FT (NAVD88)	Feet	Datum	Source
MHHW	3.54	3.54	NAVD88	<i>interpolation between NOAA titdal benchmark station Port Morris and Throgs Neck</i>
1% flood height	11.94	11.94	NAVD88	<i>FEMA Flood Insurance Rate Map for New Yorck City Panel 104 of 457 revision date September 5, 2007</i>
<i>As relevant:</i>				
0.2% flood height	-->		NAVD88	
MHW	3.19	3.19	NAVD88	<i>interpolation between NOAA titdal benchmark station Port Morris and Throgs Neck</i>
MSL	-1.61	-1.61	NAVD88	<i>interpolation between NOAA titdal benchmark station Port Morris and Throgs Neck</i>
MLLW	-3.84	-3.84	NAVD88	<i>interpolation between NOAA titdal benchmark station Port Morris and Throgs Neck</i>

Data will be converted based on the following datums:

Datum	FT (NAVD88)
NAVD88	0.00
NGVD29	-1.10
Manhattan Datum	1.65
Bronx Datum	1.51
Brooklyn Datum (Sewer)	0.61
Brooklyn Datum (Highway)	1.45
Queens Datum	1.63
Richmond Datum	2.09
Station	
MLLW	

Describe key physical features of the project.

Feature (enter name)	Feature Category	Lifespan	Elevation	Units	Datum	Ft	Ft Above NAVD88	Ft Above MHHW	Ft Above 1% flood height	Ft Above 0.2% flood height
A Parking & Storage	<input checked="" type="checkbox"/> Vulnerable <input type="checkbox"/> Critical <input type="checkbox"/> Potentially Hazardous <input type="checkbox"/> Other	2100	3.0	Feet	NAVD88	3.0	3.0	-0.5	-8.9	#VALUE!
<i>Description of Planned Uses and Materials - The lowest parking and storage level will be in the cellar. The building will use block and plank construction with precast concrete planks for the floors and concrete masonry blocks for the bearing walls and exterior masonry finishes.</i>										
B Res Lobby, retail, comm fac	<input checked="" type="checkbox"/> Vulnerable <input type="checkbox"/> Critical <input type="checkbox"/> Potentially Hazardous <input type="checkbox"/> Other	2100	20.0	Feet	NAVD88	20.0	20.0	16.5	8.1	#VALUE!
<i>Description of Planned Uses and Materials - Retail and community facility uses, the residential lobby, the laundry room, and the common recreational room will be located on the first floor.</i>										
C Mechanical Rooms	<input type="checkbox"/> Vulnerable <input checked="" type="checkbox"/> Critical <input type="checkbox"/> Potentially Hazardous <input type="checkbox"/> Other	2100	20.0	Feet	NAVD88	20.0	20.0	16.5	8.1	#VALUE!
<i>Description of Planned Uses and Materials - The lowest mechanical room level of the building will be on the first floor.</i>										
D Habitable Residential Space	<input type="checkbox"/> Vulnerable <input checked="" type="checkbox"/> Critical <input type="checkbox"/> Potentially Hazardous <input type="checkbox"/> Other	2100	35.0	Feet	NAVD88	35.0	35.0	31.5	23.1	#VALUE!
<i>Description of Planned Uses and Materials - The lowest habitable residential level of the building will be on the second floor.</i>										
E	<input type="checkbox"/> Vulnerable <input type="checkbox"/> Critical <input type="checkbox"/> Potentially Hazardous <input type="checkbox"/> Other			Feet	NAVD88					
<i>Description of Planned Uses and Materials</i>										
F	<input type="checkbox"/> Vulnerable <input type="checkbox"/> Critical <input type="checkbox"/> Potentially Hazardous <input type="checkbox"/> Other			Feet	NAVD88					
<i>Description of Planned Uses and Materials</i>										
G	<input type="checkbox"/> Vulnerable <input type="checkbox"/> Critical <input type="checkbox"/> Potentially Hazardous <input type="checkbox"/> Other			Feet	NAVD88					
<i>Description of Planned Uses and Materials</i>										
H	<input type="checkbox"/> Vulnerable <input type="checkbox"/> Critical <input checked="" type="checkbox"/> Potentially Hazardous <input type="checkbox"/> Other			Feet	NAVD88					
<i>Description of Planned Uses and Materials</i>										

Assess project vulnerability over a range of sea level rise projections.

Mean Higher High Water + Sea Level Rise

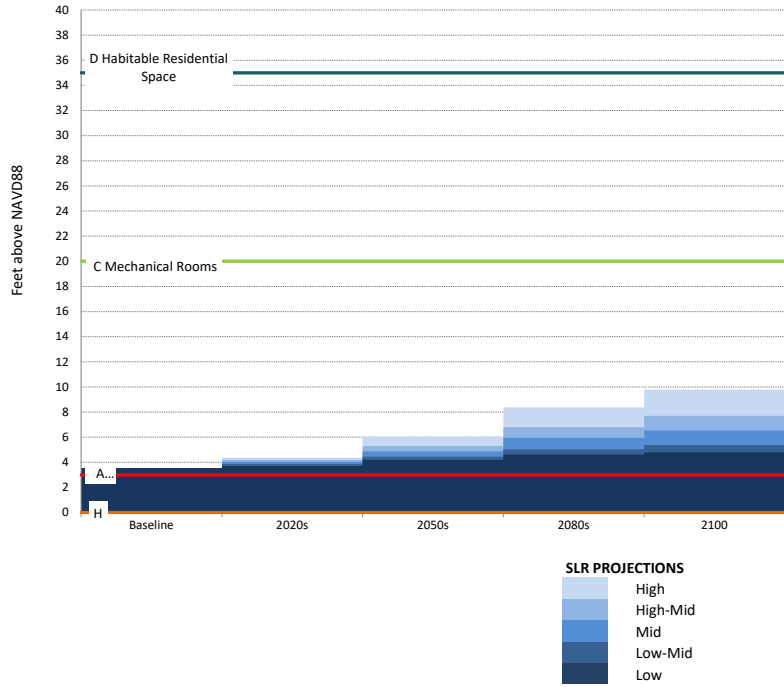

1% Flood Elevation + Sea Level Rise

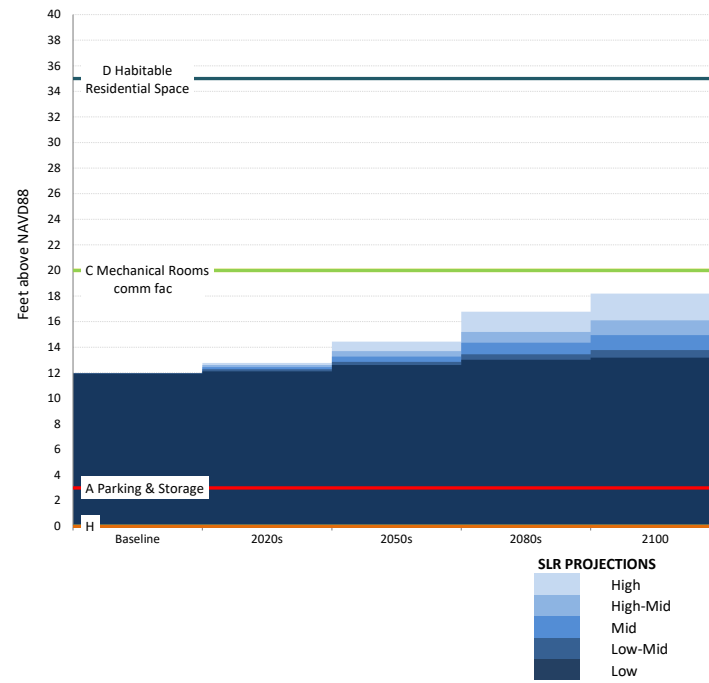

	SLR (ft)					
	Low	Low-Mid	Mid	High-Mid	High	
Baseline	0.00	0.00	0.00	0.00	0.00	2014
2020s	0.17	0.33	0.50	0.67	0.83	2020s
2050s	0.67	0.92	1.33	1.75	2.50	2050s
2080s	1.08	1.50	2.42	3.25	4.83	2080s
2100	1.25	1.83	3.00	4.17	6.25	2100

MHHW+SLR (ft above NAVD88)

	Low	Low-Mid	Mid	High-Mid	High	
Baseline	3.54	3.54	3.54	3.54	3.54	Baseline
2020s	3.71	3.87	4.04	4.21	4.37	2020s
2050s	4.21	4.46	4.87	5.29	6.04	2050s
2080s	4.62	5.04	5.96	6.79	8.37	2080s
2100	4.79	5.37	6.54	7.71	9.79	2100

1%+SLR (ft above NAVD88)

	Low	Low-Mid	Mid	High-Mid	High	
Baseline	11.94	11.94	11.94	11.94	11.94	Baseline
2020s	12.11	12.27	12.44	12.61	12.77	2020s
2050s	12.61	12.86	13.27	13.69	14.44	2050s
2080s	13.02	13.44	14.36	15.19	16.77	2080s
2100	13.19	13.77	14.94	16.11	18.19	2100

0.2%+SLR (ft above NAVD88)

	Low	Low-Mid	Mid	High-Mid	High
Baseline	#VALUE!	#VALUE!	#VALUE!	#VALUE!	#VALUE!
2020s	#VALUE!	#VALUE!	#VALUE!	#VALUE!	#VALUE!
2050s	#VALUE!	#VALUE!	#VALUE!	#VALUE!	#VALUE!
2080s	#VALUE!	#VALUE!	#VALUE!	#VALUE!	#VALUE!
2100	#VALUE!	#VALUE!	#VALUE!	#VALUE!	#VALUE!

	0	1
A Parking & Storage	3	3
B Res Lobby, retail, comm fac	20	20
C Mechanical Rooms	20	20
D Habitable Residential Space	35	35
E	0	0
F	0	0
G	0	0
H	0	0

SLR (in)

Low	Low-Mid	Mid	High-Mid	High
0	0	0	0	0
2	4	6	8	10
8	11	16	21	30
13	18	29	39	58
15	22	36	50	75

MLLW+SLR (ft above NAVD88)

Low	Low-Mid	Mid	High-Mid	High
-3.84	-3.84	-3.84	-3.84	-3.84
-3.67	-3.51	-3.34	-3.17	-3.01
-3.17	-2.92	-2.51	-2.09	-1.34
-2.76	-2.34	-1.42	-0.59	0.99
-2.59	-2.01	-0.84	0.33	2.41

MSL+SLR (ft above NAVD88)

Low	Low-Mid	Mid	High-Mid	High
-1.61	-1.61	-1.61	-1.61	-1.61
-1.44	-1.28	-1.11	-0.94	-0.78
-0.94	-0.69	-0.28	0.14	0.89
-0.53	-0.11	0.81	1.64	3.22
-0.36	0.22	1.39	2.56	4.64

Mean Lower Low Water + Sea Level Rise

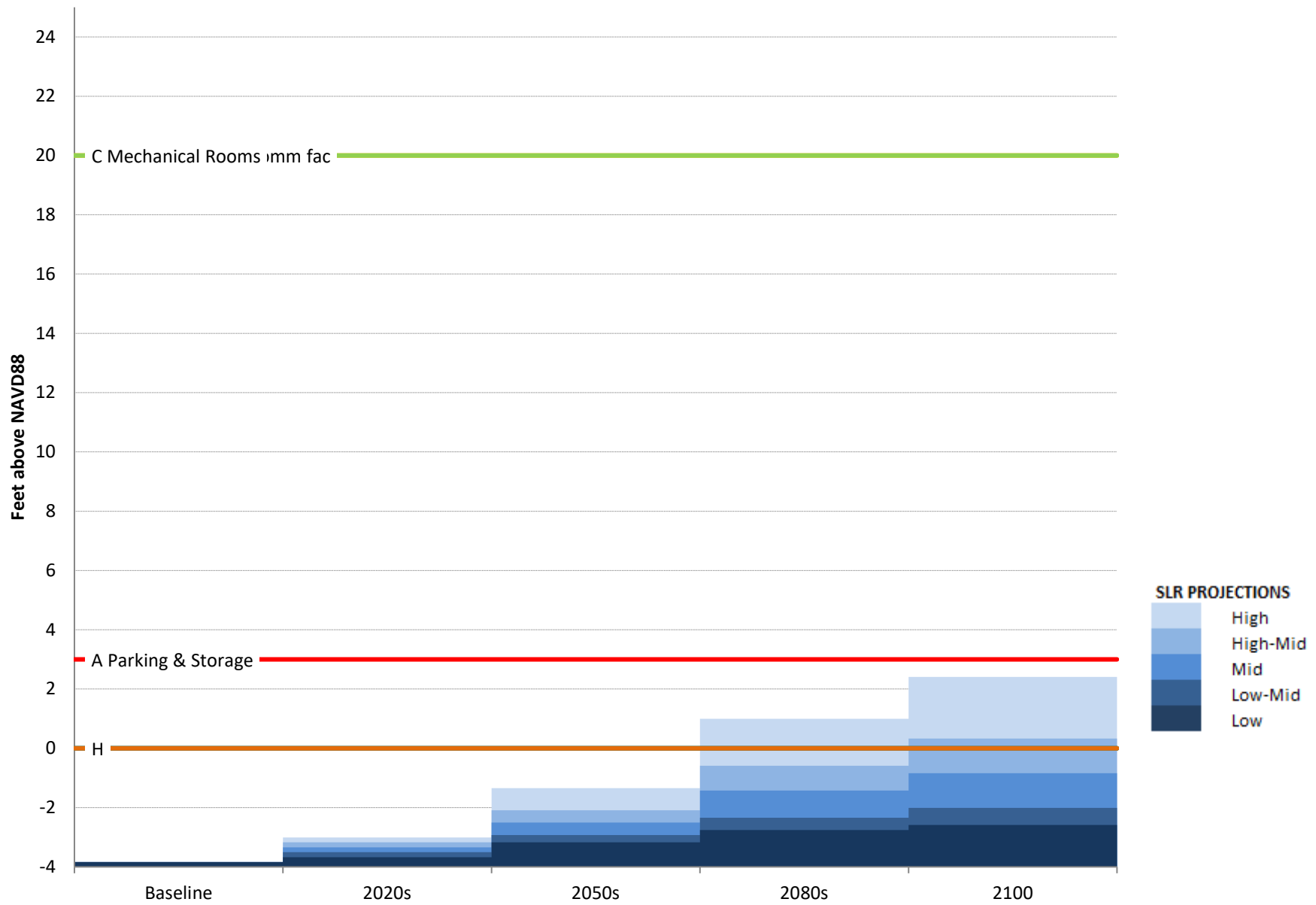

Mean Sea Level + Sea Level Rise

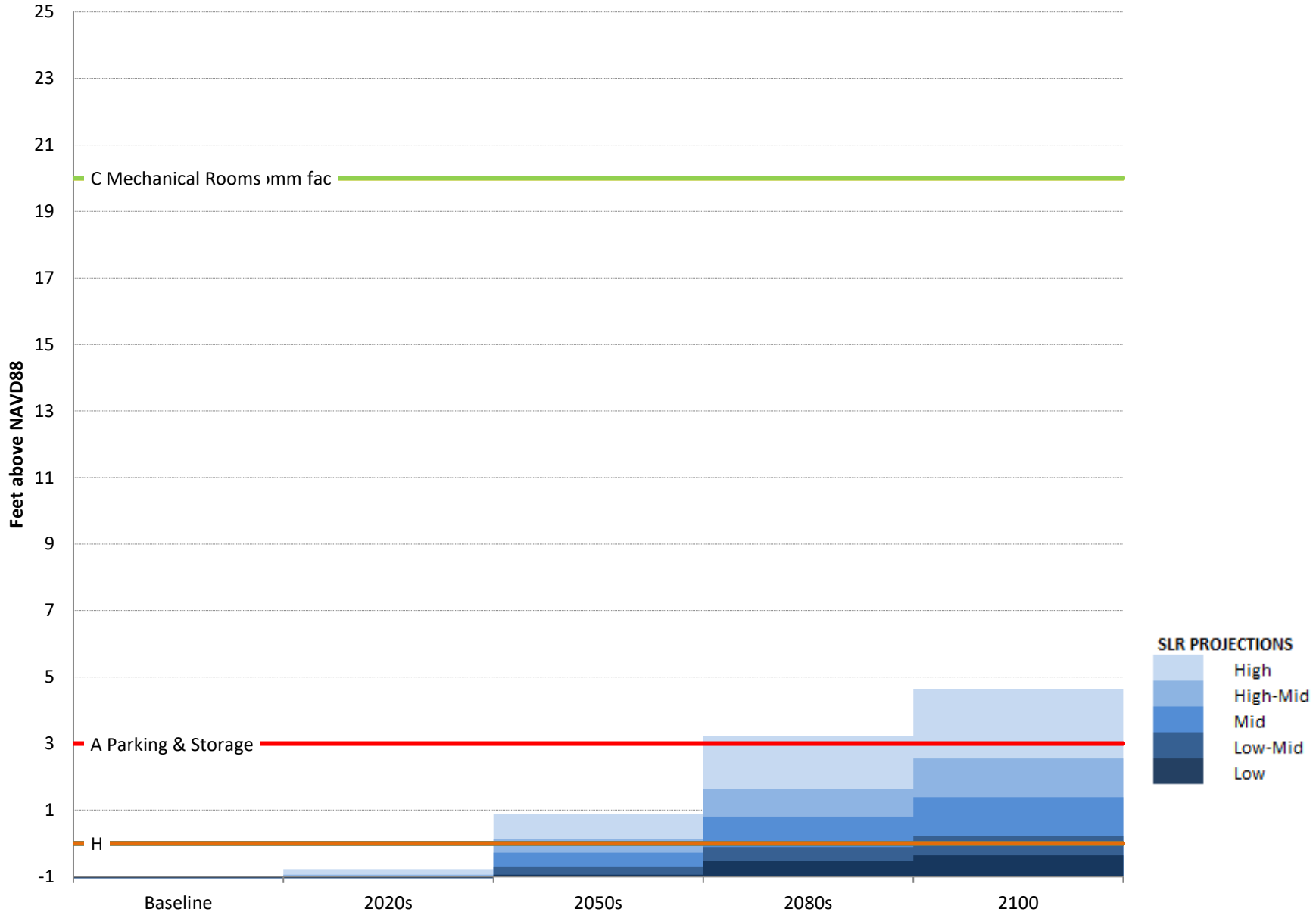

0.2% Flood Elevation + Sea Level Rise

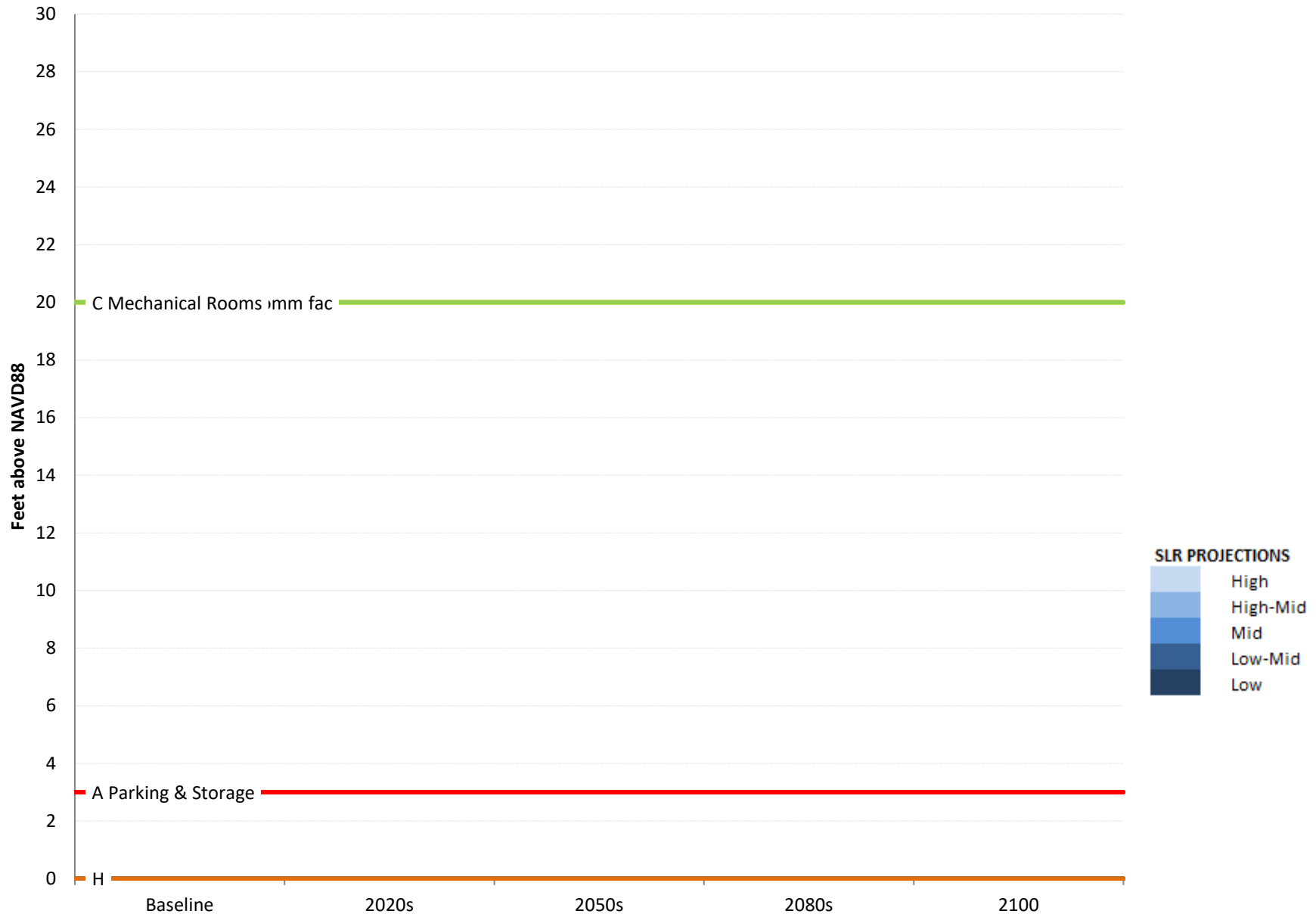

John Strauss

From: Allan Zaretsky (DCP) <AZARETSKY@planning.nyc.gov>
Sent: Wednesday, August 22, 2018 1:03 PM
To: John Strauss
Cc: Anthony Howard (DCP); Justin Lamorella (DCP); Michael Marrella (DCP)
Subject: WRP Consistency Determination: Blondell Commons (WRP #17-029)

Hello,

We have completed the review of the project as described below for consistency with the policies and intent of the New York City Waterfront Revitalization Program (WRP).

Blondell Commons (CEQR # 17DCP194X): Rezoning from MI-1 to R7A with C2-4 overlay to develop a mixed-use retail and residential building with 228 units; text amendment to Appendix F to map area as MIH designated area; Demapping of Fink Avenue.

Based on the information submitted, the Waterfront Open Space Division, on behalf of the New York City Coastal Commission, having reviewed the waterfront aspect of this action, finds that the actions will not substantially hinder the achievement of any Waterfront Revitalization Program (WRP) policy and hereby determines the project consistent with the WRP policies.

This determination is only applicable to the information received and the current proposal. Any additional information or project modifications would require an independent consistency review.

For your records, this project has been assigned WRP # 17-029. If there are any questions regarding this review, please contact me.

Regards,

Allan Zaretsky
Planner | WATERFRONT & OPEN SPACE DIVISION
Waterfront Revitalization Program Consistency Review

NYC DEPT. OF CITY PLANNING
120 Broadway, 31st Floor • NEW YORK, NY 10271
t 212.720.3448 • azaretsky@planning.nyc.gov

<http://www1.nyc.gov/site/planning/applicants/wrp/wrp.page>

**HISTORIC AND CULTURAL
RESOURCES APPENDIX**

ENVIRONMENTAL REVIEW

Project number: DEPARTMENT OF CITY PLANNING / 77DCP151X
Project: BLONDELL COMMONS
Date received: 4/28/2017

Properties with no Architectural or Archaeological significance:

- 1) ADDRESS: 1338-1348 Blondell Avenue, BBL: 2041340001
- 2) ADDRESS: 2601 Westchester Avenue, BBL: 2041330001
- 3) ADDRESS: 1314 Blondell Avenue, BBL: 2041330002
- 4) ADDRESS: 1306 Cooper Avenue, BBL: 2041330063
- 5) ADDRESS: 1332 Blondell Avenue, BBL: 2041330010
- 6) ADDRESS: 2611 Westchester Avenue, BBL: 2041330061
- 7) ADDRESS: 1314 Cooper Avenue, BBL: 2041330062

Gina Santucci

5/3/2017

SIGNATURE
Gina Santucci, Environmental Review Coordinator

DATE

File Name: 32352_FSO_DNP_05032017.doc

TRANSPORTATION APPENDIX

TECHNICAL APPENDIX

CEQR LEVEL I SCREENING ANALYSIS

Figure 16-1: Travel Demand Factors

		Residential		Local Retail		Day Care Center		Medical Office	
Program Size	Size	380		9,025		1,012		1,012	
	Unit	dwelling units		gsf		gsf		gsf	
Daily Person Trip Rate	Weekday	8.075		205		33		127	
	Saturday	9.6		240		2		127	
	Unit	per dwelling unit ¹		per 1,000 gsf ¹		per 1,000 gsf ⁴		per 1,000 gsf ⁴	
Daily Truck Trip Rate	Weekday	0.06		0.35		0.07		0.29	
	Saturday	0.02		0.04		0.00		0.29	
	Unit	per dwelling unit ¹		per 1,000 gsf ¹		per 1,000 gsf ⁴		per 1,000 gsf ⁴	
Modal Split		Weekday ²	Saturday ²	Weekday ⁴	Saturday ⁴	Weekday ⁴	Saturday ⁴	Weekday ⁴	Saturday ⁴
	Auto	28.0%	28.0%	3.0%	3.0%	5.0%	5.0%	30.0%	30.0%
	Taxi	2.5%	2.5%	2.0%	2.0%	1.0%	1.0%	2.0%	2.0%
	Bus	10.5%	10.5%	10.0%	10.0%	6.0%	6.0%	18.0%	18.0%
	Subway	49.0%	49.0%	5.0%	5.0%	3.0%	3.0%	33.0%	33.0%
	Walk	10.0%	10.0%	80.0%	80.0%	85.0%	85.0%	17.0%	17.0%
		100.0%	100.0%	100.0%	100.0%	100.0%	100.0%	100.0%	100.0%
Vehicle Occupancy		(2)		(4)		(4)		(4)	
	Auto	1.15		1.60		1.65		1.50	
	Taxi	1.15		1.20		1.40		1.50	
Linked Trips		0%	0%	15%	15%	0%	0%	0%	0%
Temporal Distribution		(1)		(1)		(4)		(4)	
	Weekday AM	10.0%		3.0%		16.0%		4.0%	
	Weekday MID	5.0%		19.0%		5.0%		11.0%	
	Weekday PM	11.0%		10.0%		19.0%		12.0%	
	Saturday MID	8.0%		10.0%		12.0%		11.0%	
Truck Temporal Distribution		(1)		(1)		(4)		(4)	
	Weekday AM	12.0%		8.0%		9.6%		3.0%	
	Weekday MID	9.0%		11.0%		11.0%		11.0%	
	Weekday PM	2.0%		2.0%		1.0%		1.0%	
	Saturday MID	9.0%		11.0%		0.0%		0.0%	
Directional Distribution		IN ³	OUT ³	IN ¹	OUT ¹	IN ⁴	OUT ⁴	IN ⁴	OUT ⁴
	Weekday AM	15%	85%	50%	50%	53%	47%	89%	11%
	Weekday MID	50%	50%	50%	50%	50%	50%	51%	49%
	Weekday PM	70%	30%	50%	50%	47%	53%	48%	52%
	Saturday MID	50%	50%	55%	45%	47%	53%	41%	59%
Truck Directional Distribution		IN ³	OUT ³	IN ⁴	OUT ⁴	IN ⁴	OUT ⁴	IN ⁴	OUT ⁴
	Weekday AM	50%	50%	50%	50%	50%	50%	50%	50%
	Weekday MID	50%	50%	50%	50%	50%	50%	50%	50%
	Weekday PM	50%	50%	50%	50%	50%	50%	5%	5%
	Saturday MID	50%	50%	50%	50%	50%	50%	50%	50%

¹2014 CEQR Technical Manual Table 16-2.

²2011-2015 American Community Survey 5-year Estimates. Table B08006: Sex of Workers by Means of Transportation to Work. Census Tracts 96, 200, 202, 204, 266.01, 284, and 296 (Bronx).

³Hunters Point South Rezoning and Related Actions (2008). Table 16-9. Weekday Travel Demand Characteristics: Build Condition.

⁴Jerome Avenue Rezoning FEIS (2018). Table 13-8 Transportation Planning Factors.

Figure 16-2: Project Increment Trip Generation Estimates

		Residential		Local Retail		Day Care Center		Medical Office		Total		
Person Trips												
Daily Trips	Weekday	3,069		1,850		33		129		5,081		
	Saturday	3,648		2,166		2		129		5,945		
Peak Hour Trips	Weekday AM	307		56		5		5		373		
	Weekday MID	153		352		2		14		521		
	Weekday PM	338		185		6		15		544		
	Saturday MID	292		217		0		14		523		
		IN	OUT	IN	OUT	IN	OUT	IN	OUT	IN	OUT	TOTAL
Weekday AM	Auto	13	73	1	1	0	0	1	0	15	74	89
	Taxi	1	7	0	0	0	0	0	0	1	7	8
	Bus	5	27	2	2	0	0	1	0	8	29	37
	Subway	23	128	1	1	0	0	1	0	25	129	154
	Pedestrian	4	26	20	20	3	2	1	1	28	49	77
	Total	46	261	24	24	3	2	4	1	77	288	365
Weekday MID	Auto	22	21	5	4	0	0	2	2	29	27	56
	Taxi	2	2	3	3	0	0	0	0	5	5	10
	Bus	8	8	15	15	0	0	1	1	24	24	48
	Subway	38	37	8	7	0	0	2	2	48	46	94
	Pedestrian	7	8	119	120	1	1	2	2	129	131	260
	Total	77	76	150	149	1	1	7	7	235	233	468
Weekday PM	Auto	66	28	2	2	0	0	2	2	70	32	102
	Taxi	6	3	2	2	0	0	0	0	8	5	13
	Bus	25	11	8	8	0	0	1	1	34	20	54
	Subway	116	49	4	4	0	0	2	3	122	56	178
	Pedestrian	24	10	63	62	3	3	2	2	92	77	169
	Total	237	101	79	78	3	3	7	8	326	190	516
Saturday MID	Auto	41	41	3	2	0	0	2	2	46	45	91
	Taxi	4	4	2	2	0	0	0	0	6	6	12
	Bus	15	15	10	8	0	0	1	1	26	24	50
	Subway	72	72	5	4	0	0	2	3	79	79	158
	Pedestrian	14	14	81	67	0	0	1	2	96	83	179
	Total	146	146	101	83	0	0	6	8	253	237	490
Vehicle Trips												
		IN	OUT	IN	OUT	IN	OUT	IN	OUT	IN	OUT	TOTAL
Weekday AM	Auto	11	63	1	1	0	0	1	0	13	64	77
	Taxi	1	6	0	0	0	0	0	0	1	6	7
	Taxi Balanced ¹	7	7	0	0	0	0	0	0	7	7	14
	Truck	1	1	0	0	0	0	0	0	1	1	2
	Total	19	71	1	1	0	0	1	0	21	72	93
Weekday MID	Auto	19	18	3	3	0	0	1	1	23	22	45
	Taxi	2	2	3	3	0	0	0	0	5	5	10
	Taxi Balanced ¹	4	4	6	6	0	0	0	0	10	10	20
	Truck	1	1	0	0	0	0	0	0	1	1	2
	Total	24	23	9	9	0	0	1	1	34	33	67
Weekday PM	Auto	57	24	1	1	0	0	1	1	59	26	85
	Taxi	5	3	2	2	0	0	0	0	7	5	12
	Taxi Balanced ¹	8	8	4	4	0	0	0	0	12	12	24
	Truck	1	1	0	0	0	0	0	0	1	1	2
	Total	66	33	5	5	0	0	1	1	72	39	111
Saturday MID	Auto	36	36	2	1	0	0	1	1	39	38	77
	Taxi	3	3	2	2	0	0	0	0	5	5	10
	Taxi Balanced ¹	6	6	4	4	0	0	0	0	10	10	20
	Truck	1	1	0	0	0	0	0	0	1	1	2
	Total	43	43	6	5	0	0	1	1	50	49	99
Pedestrian Trips ²												
		IN	OUT	IN	OUT	IN	OUT	IN	OUT	IN	OUT	TOTAL
Weekday AM	Total Pedestrians	32	181	23	23	3	2	3	1	61	207	268
Weekday MID	Total Pedestrians	53	53	142	142	1	1	5	5	201	201	402
Weekday PM	Total Pedestrians	165	70	75	74	3	3	5	6	248	153	401
Saturday MID	Total Pedestrians	101	101	96	79	0	0	4	6	201	186	387

¹Taxi overlap not permitted by the 2014 CEQR Technical Manual for locations outside of Manhattan.

²Total pedestrian trips include all trips via transit (bus and subway) plus unique pedestrian trips.

PROPOSED ACTIONS: NEW VEHICULAR TRIPS

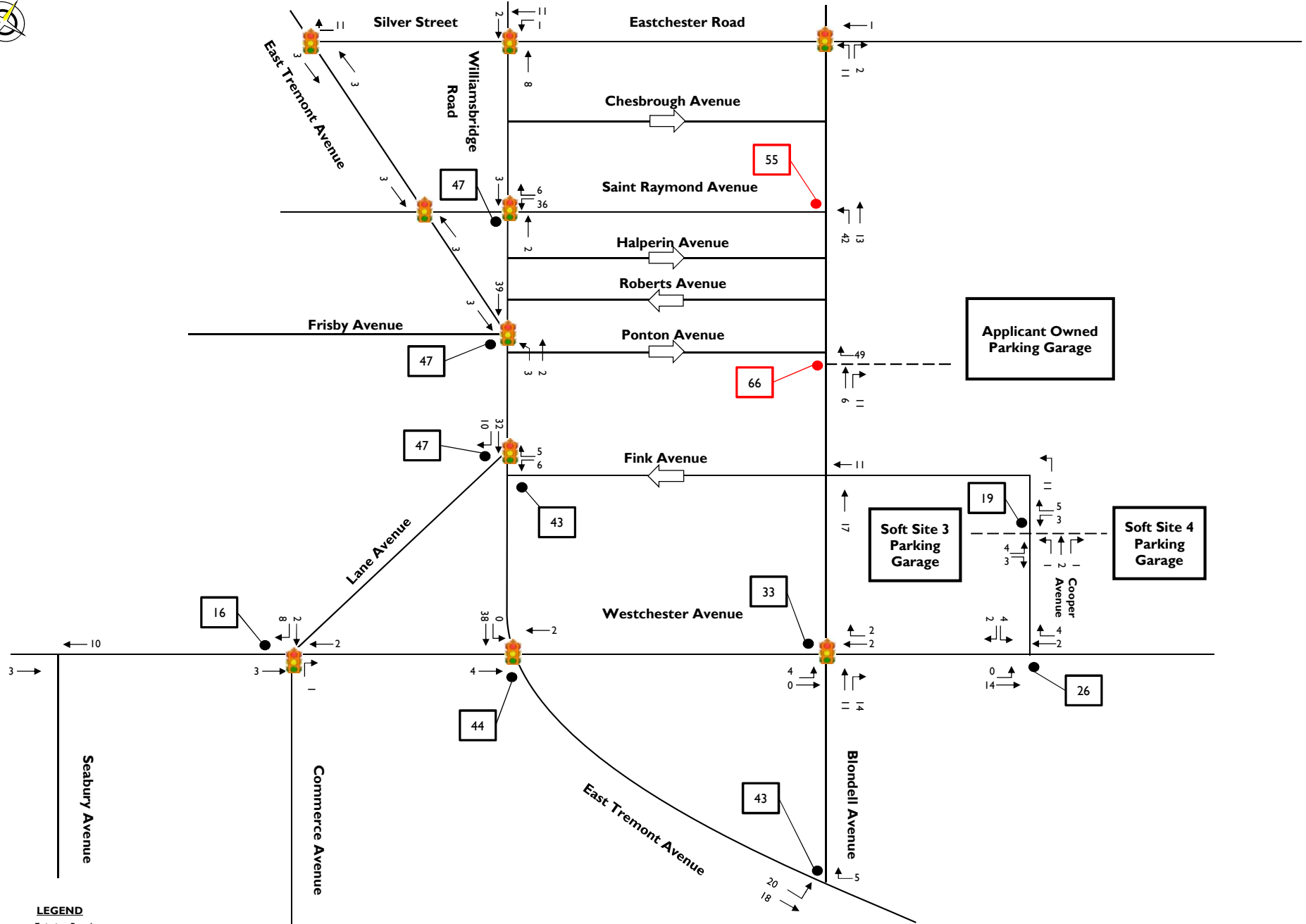

LEGEND
 — Existing Roadway
 - - - Proposed Driveway
 ← AM Peak Hour Volumes
 Signalized Intersection

	<p align="center">Blondell Commons Rezoning Blondell Avenue Westchester Square, Bronx, New York Transportation Impact Analysis</p>	<p align="center">FIGURE 16-3: Weekday AM Total "New" Trips</p>
--	---	--

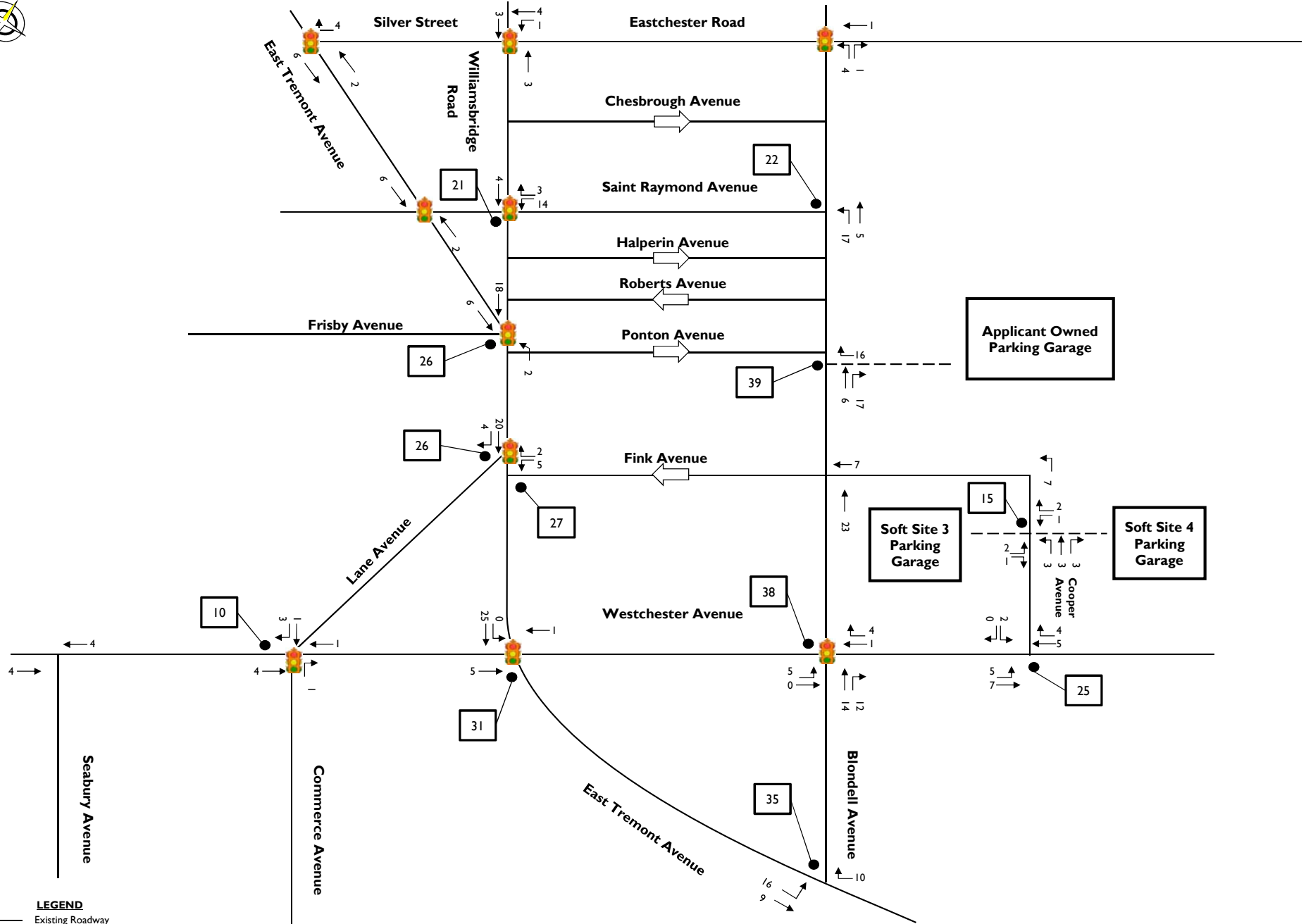

- LEGEND**
- Existing Roadway
 - - - Proposed Driveway
 - ← MID Peak Hour Volumes
 - 🚦 Signalized Intersection

	<p>Blondell Commons Rezoning Blondell Avenue Westchester Square, Bronx, New York Transportation Impact Analysis</p>	<p>FIGURE 16-4: Weekday MID Total "New" Trips</p>
--	--	--

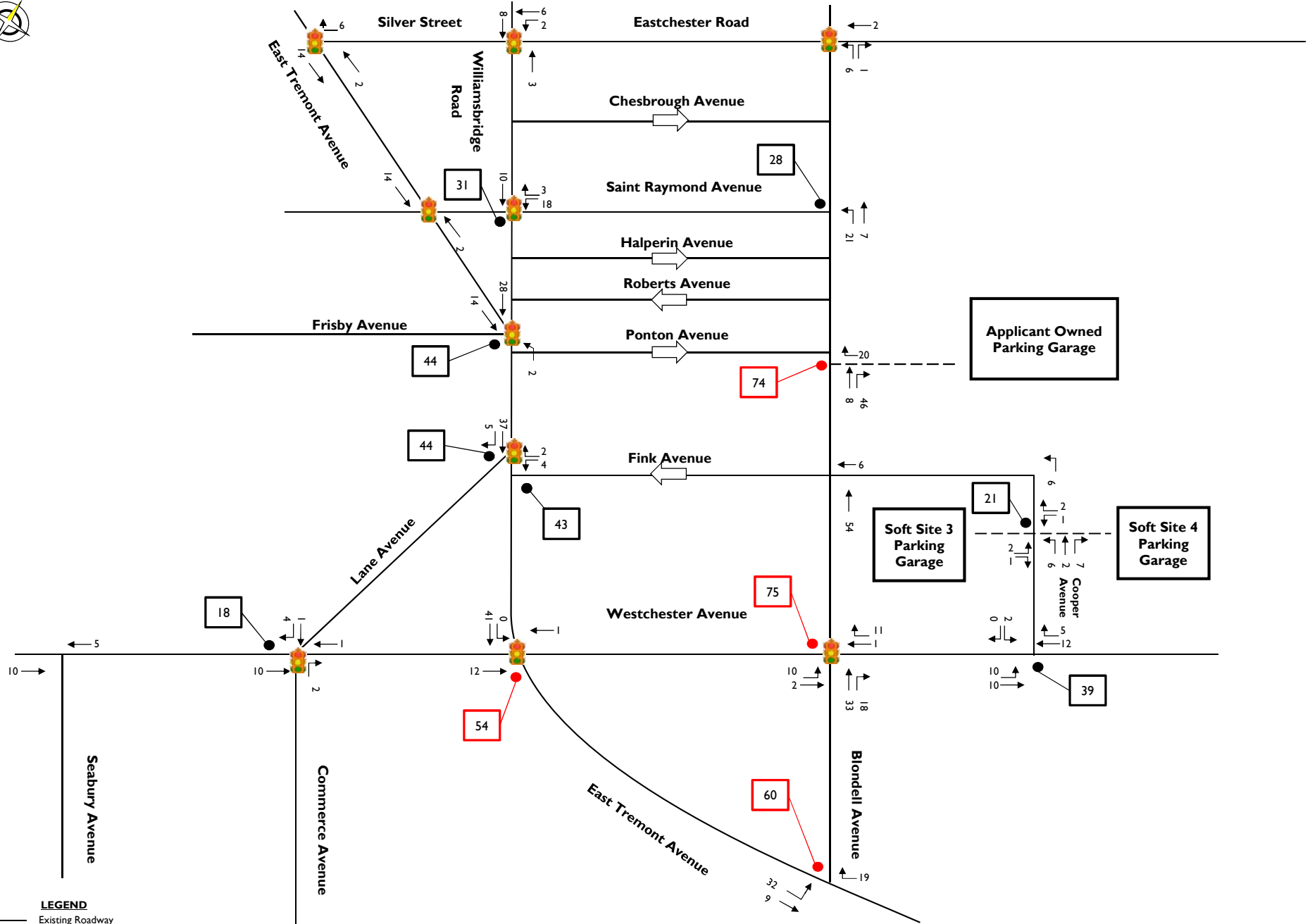

LEGEND

- Existing Roadway
- - - Proposed Driveway
- ← PM Peak Hour Volumes
- 🚦 Signalized Intersection



Blondell Commons Rezoning
Blondell Avenue
Westchester Square, Bronx, New York
Transportation Impact Analysis

FIGURE 16-5: Weekday PM
Total "New" Trips

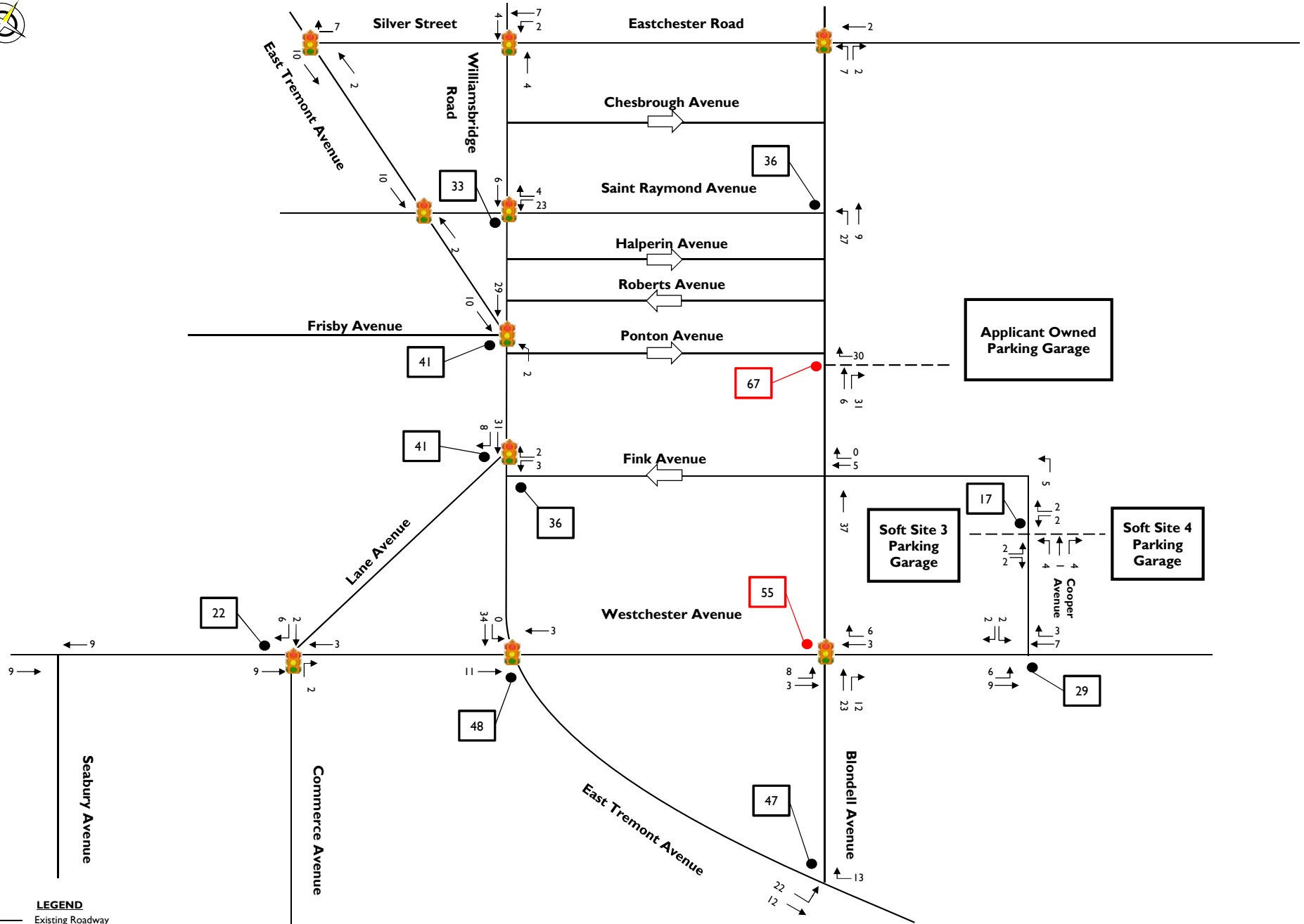

LEGEND

- Existing Roadway
- - - Proposed Driveway
- ← SAT Peak Hour Volumes
- 🚦 Signalized Intersection



Blondell Commons Rezoning
Blondell Avenue
Westchester Square, Bronx, New York
Transportation Impact Analysis

FIGURE I6-6: Saturday
Total "New" Trips

PROPOSED ACTIONS: NEW PEDESTRIAN TRIPS

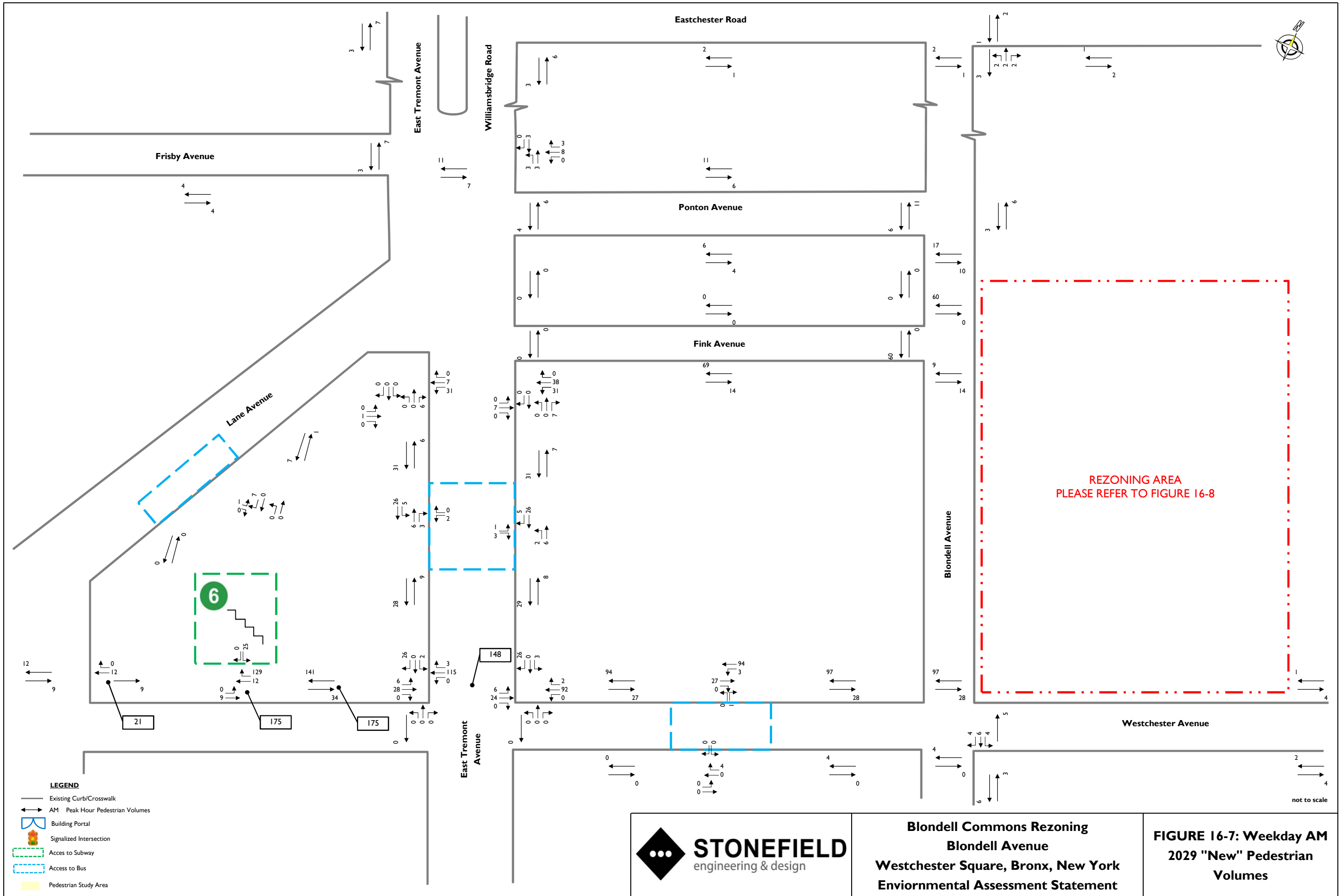

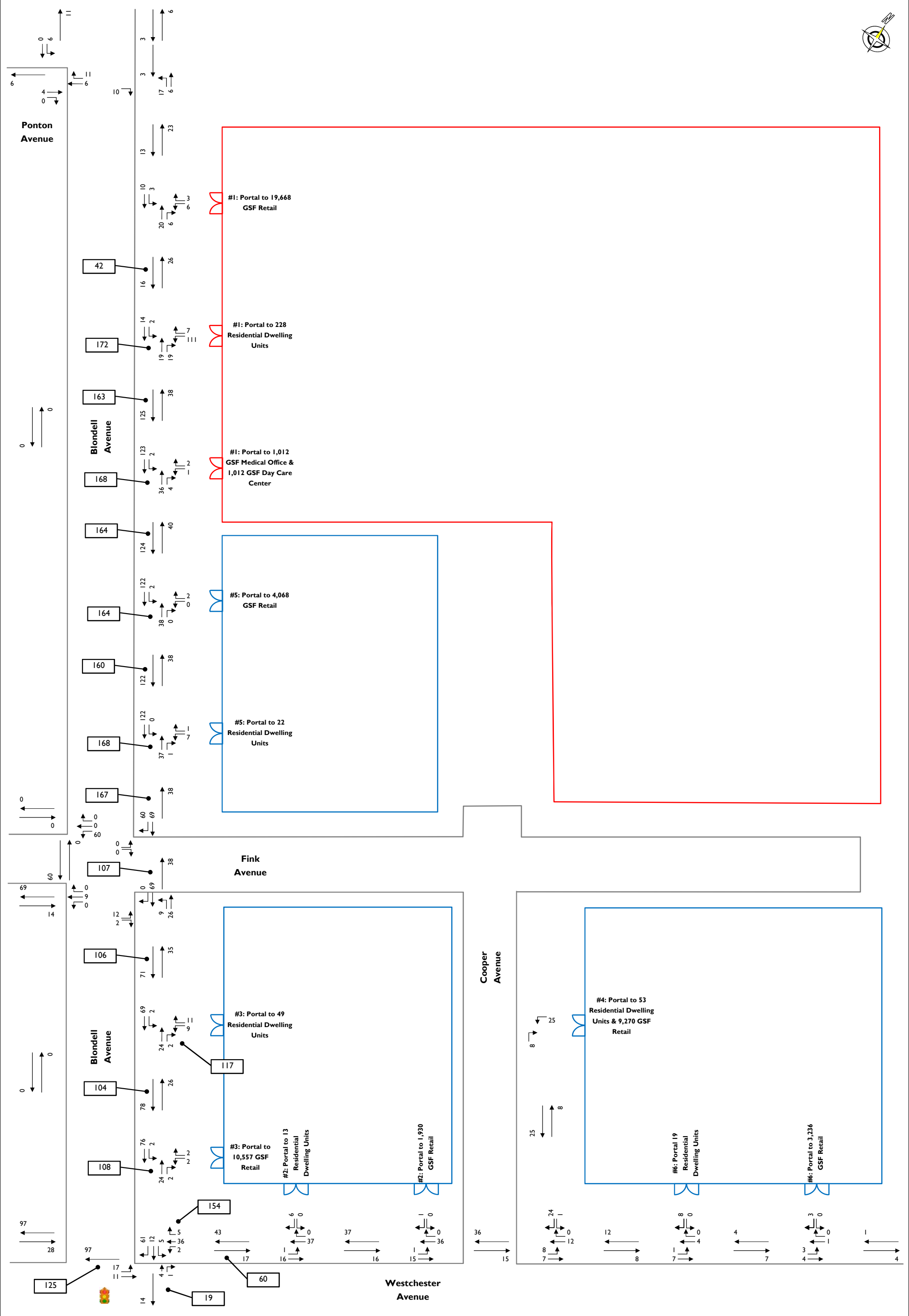

**Blondell Commons Rezoning
Blondell Avenue
Westchester Square, Bronx, New York
Environmental Assessment Statement**

**FIGURE 16-8: Weekday AM
2029 "New" Pedestrian
Volumes**

LEGEND

- Existing Curb/Crosswalk
- AM Peak Hour Volumes
- Building Portal
- Signalized Intersection
- Pedestrian Study Area

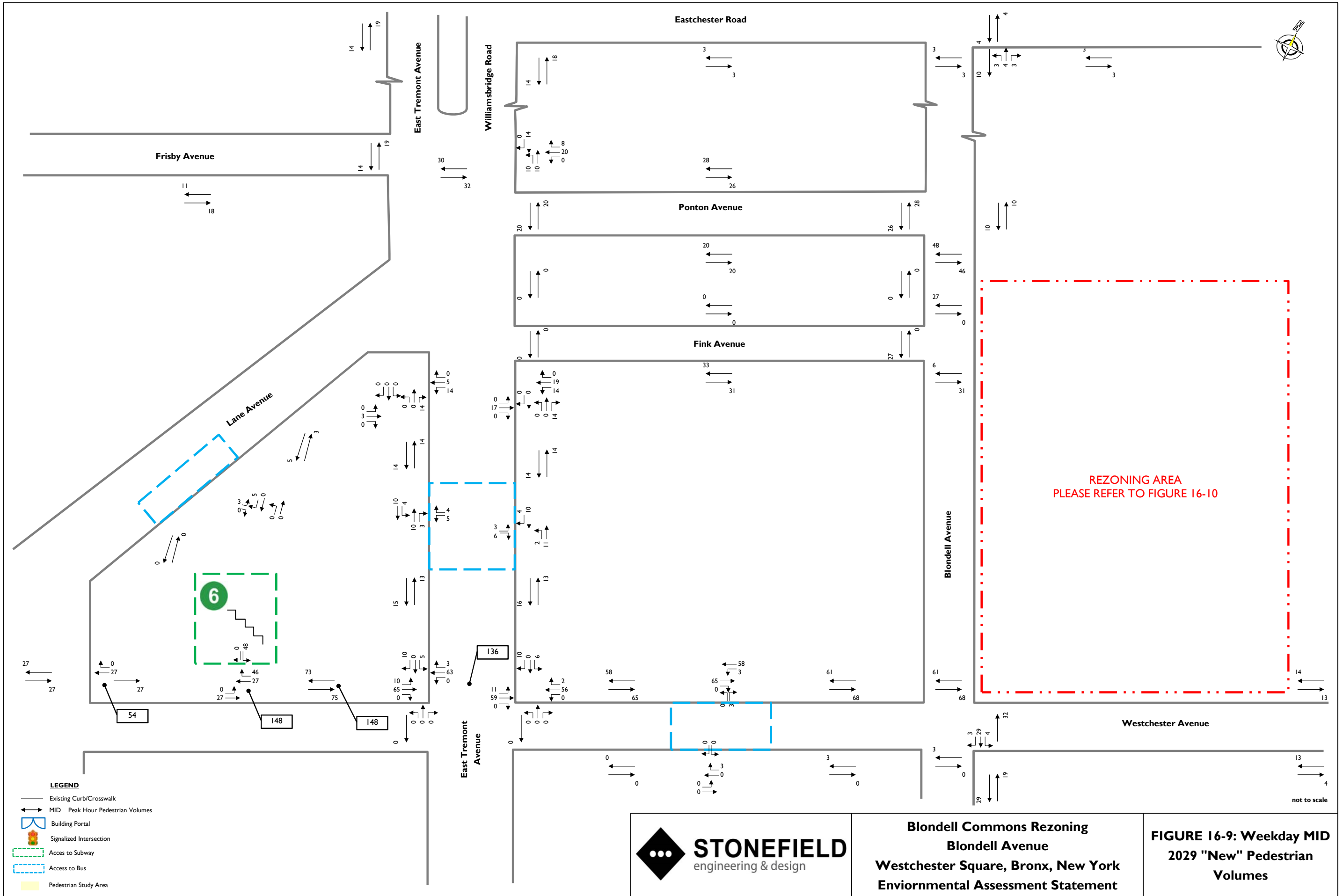

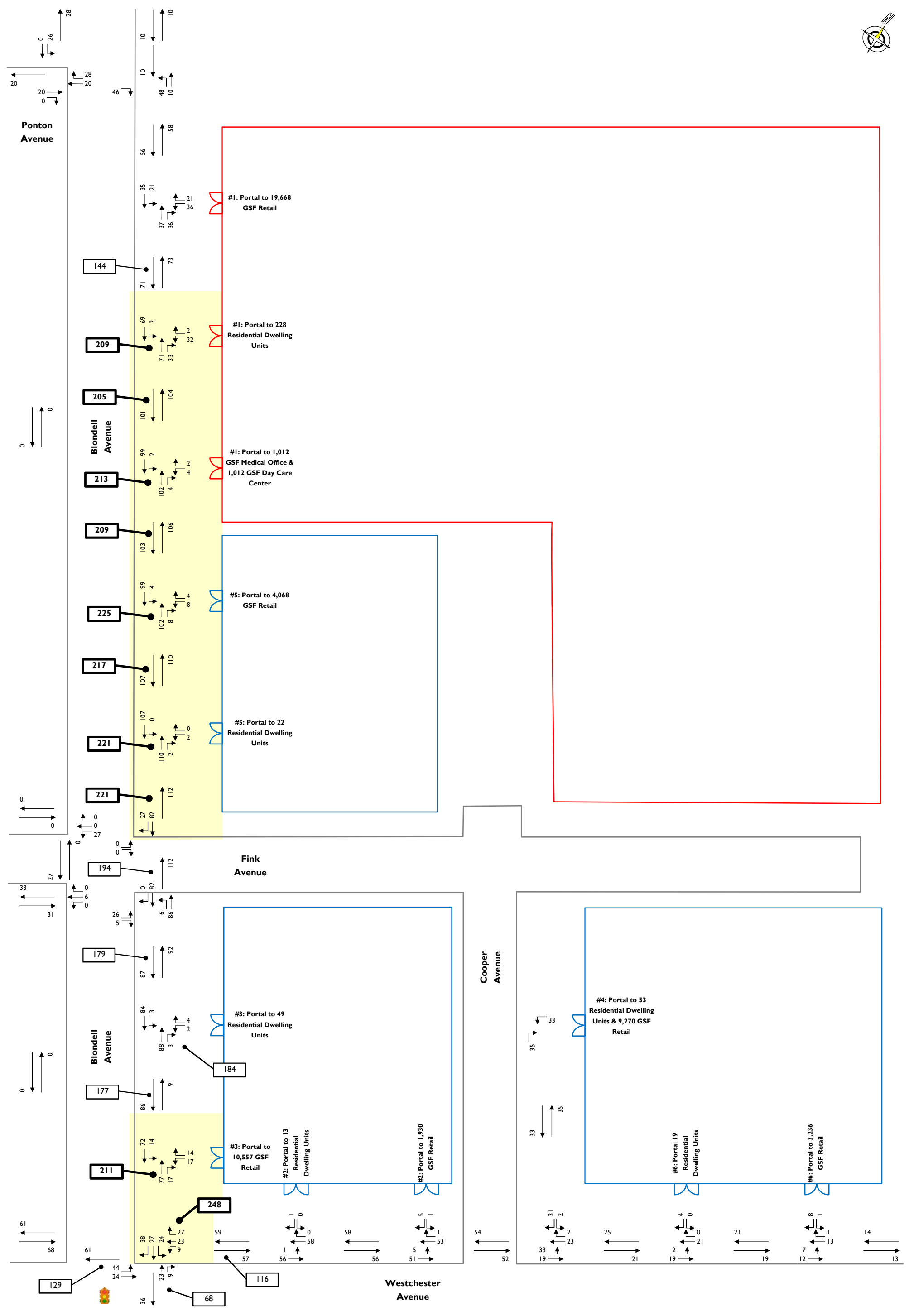

Blondell Commons Rezoning
Blondell Avenue
Westchester Square, Bronx, New York
Environmental Assessment Statement

FIGURE 16-10: Weekday MID 2029 "New" Pedestrian Volumes

- LEGEND**
- Existing Curb/Crosswalk
 - MID Peak Hour Volumes
 - Building Portal
 - Signalized Intersection
 - Pedestrian Study Area

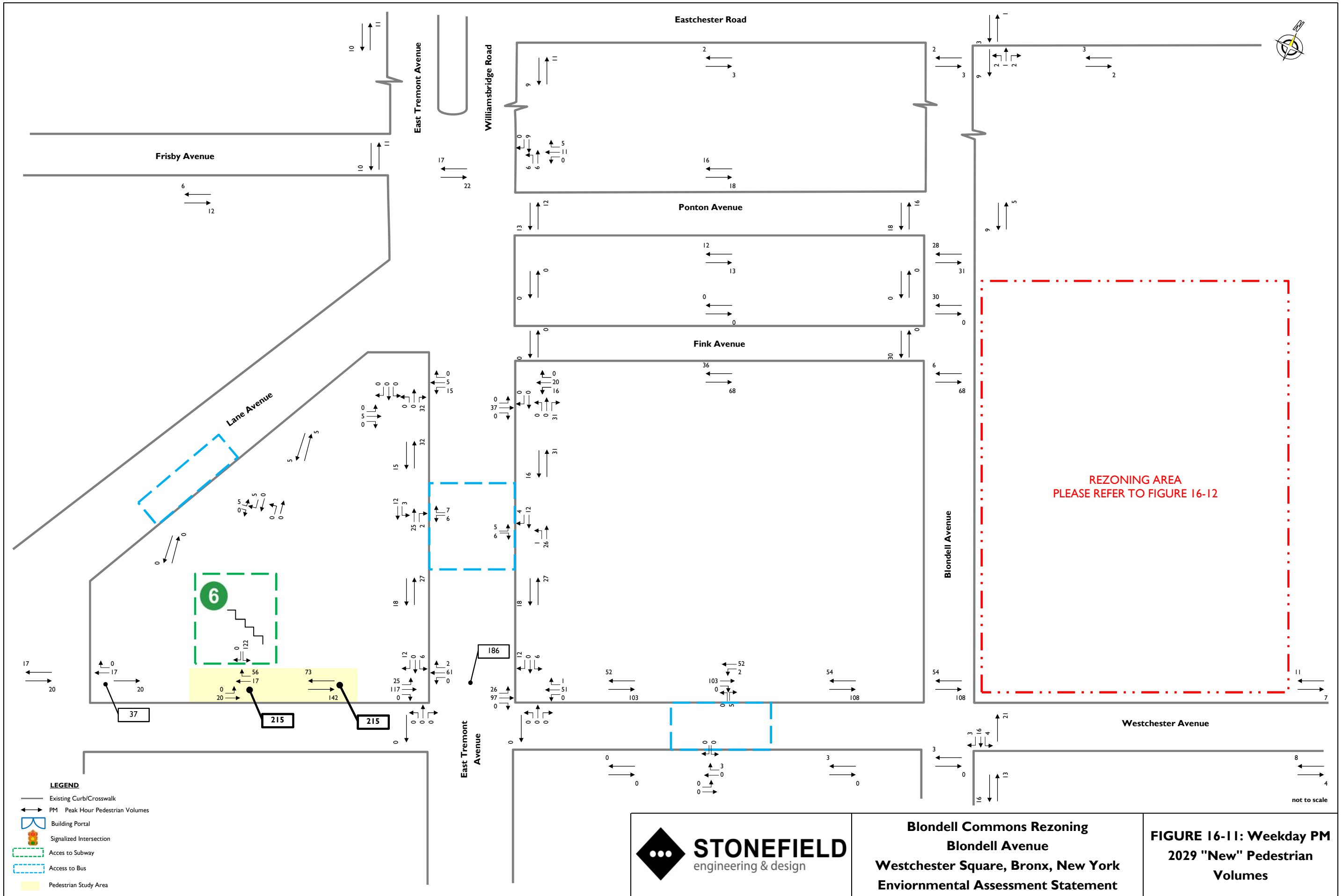

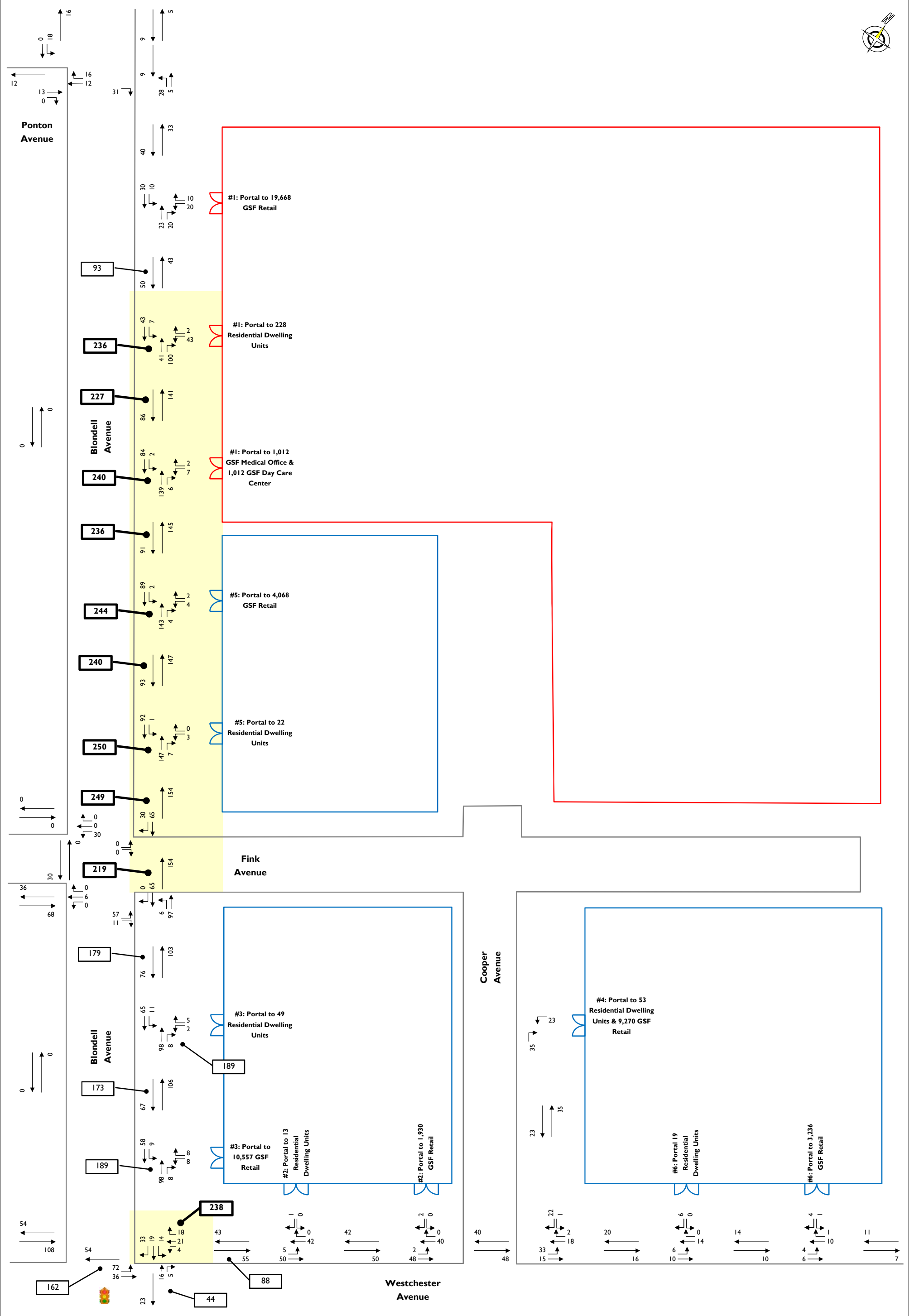

**Blondell Commons Rezoning
Blondell Avenue
Westchester Square, Bronx, New York
Environmental Assessment Statement**

**FIGURE 16-12: Weekday PM
2029 "New" Pedestrian
Volumes**

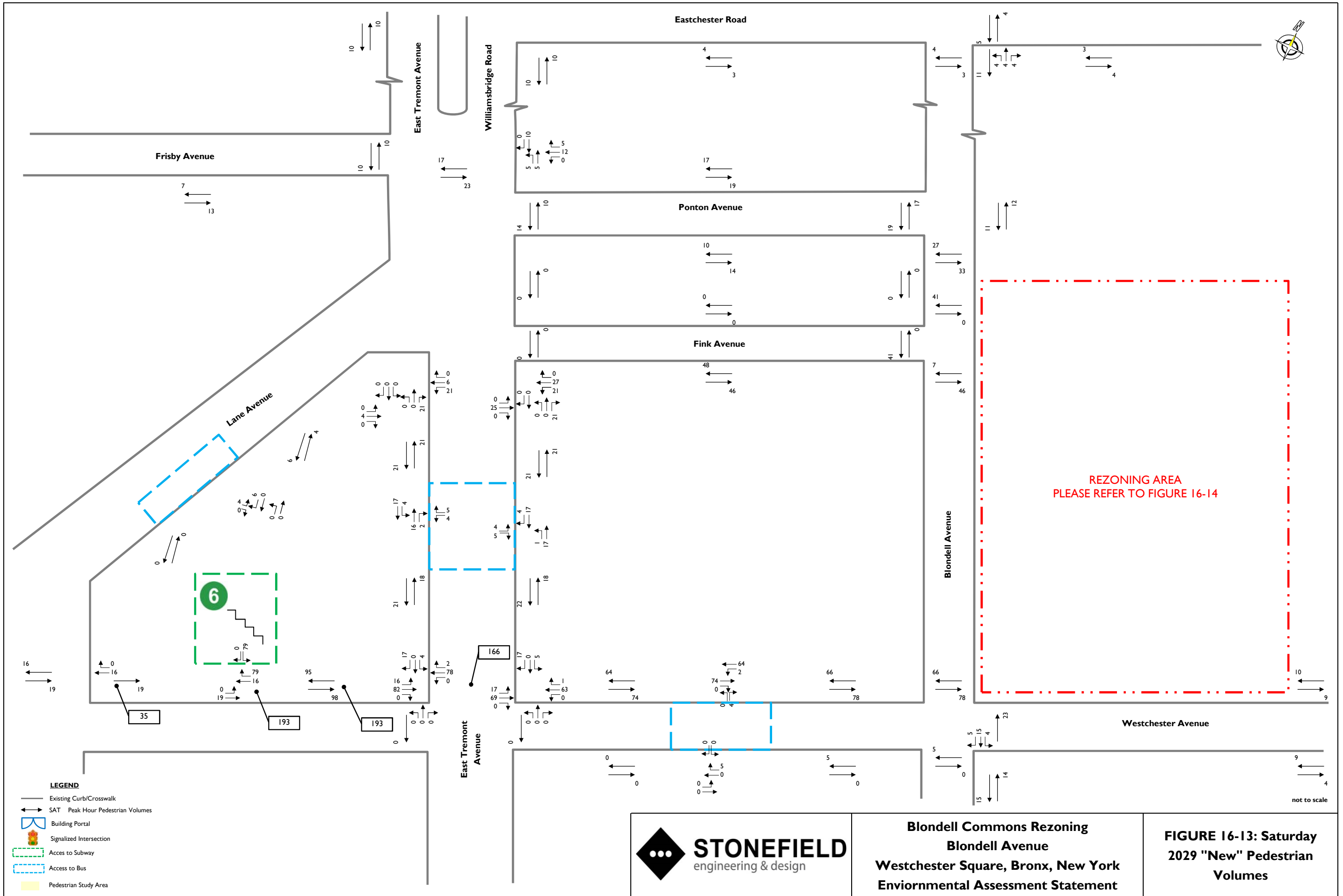

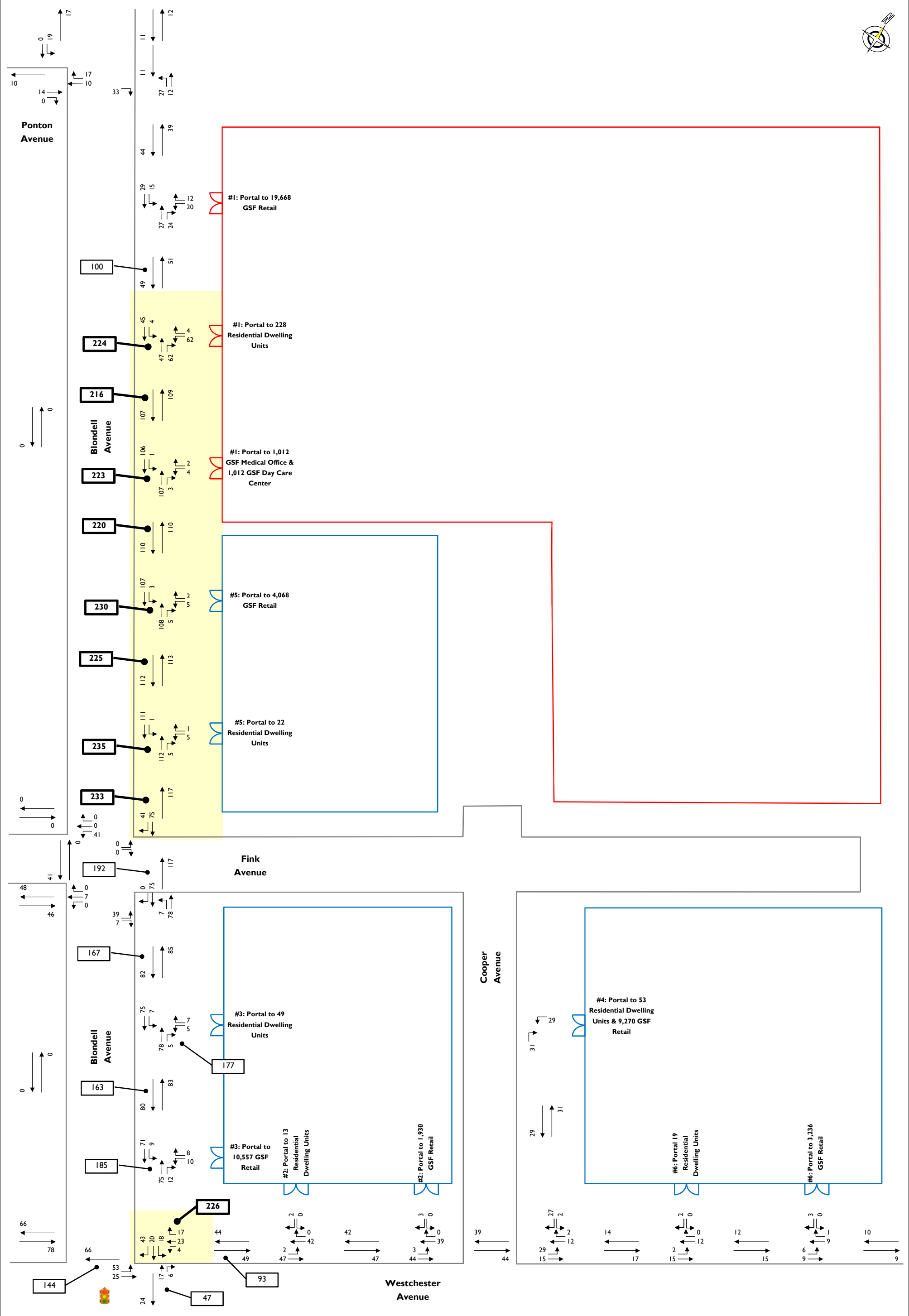

**Blondell Commons Rezoning
Blondell Avenue
Westchester Square, Bronx, New York
Environmental Assessment Statement**

**FIGURE 16-14: Saturday
2029 "New" Pedestrian
Volumes**

LEGEND

- Existing Curb/Crosswalk
- SAT Peak Hour Volumes
- Building Portal
- Signalized Intersection
- Pedestrian Study Area

**2018 EXISTING
VEHICULAR TRAFFIC VOLUMES**

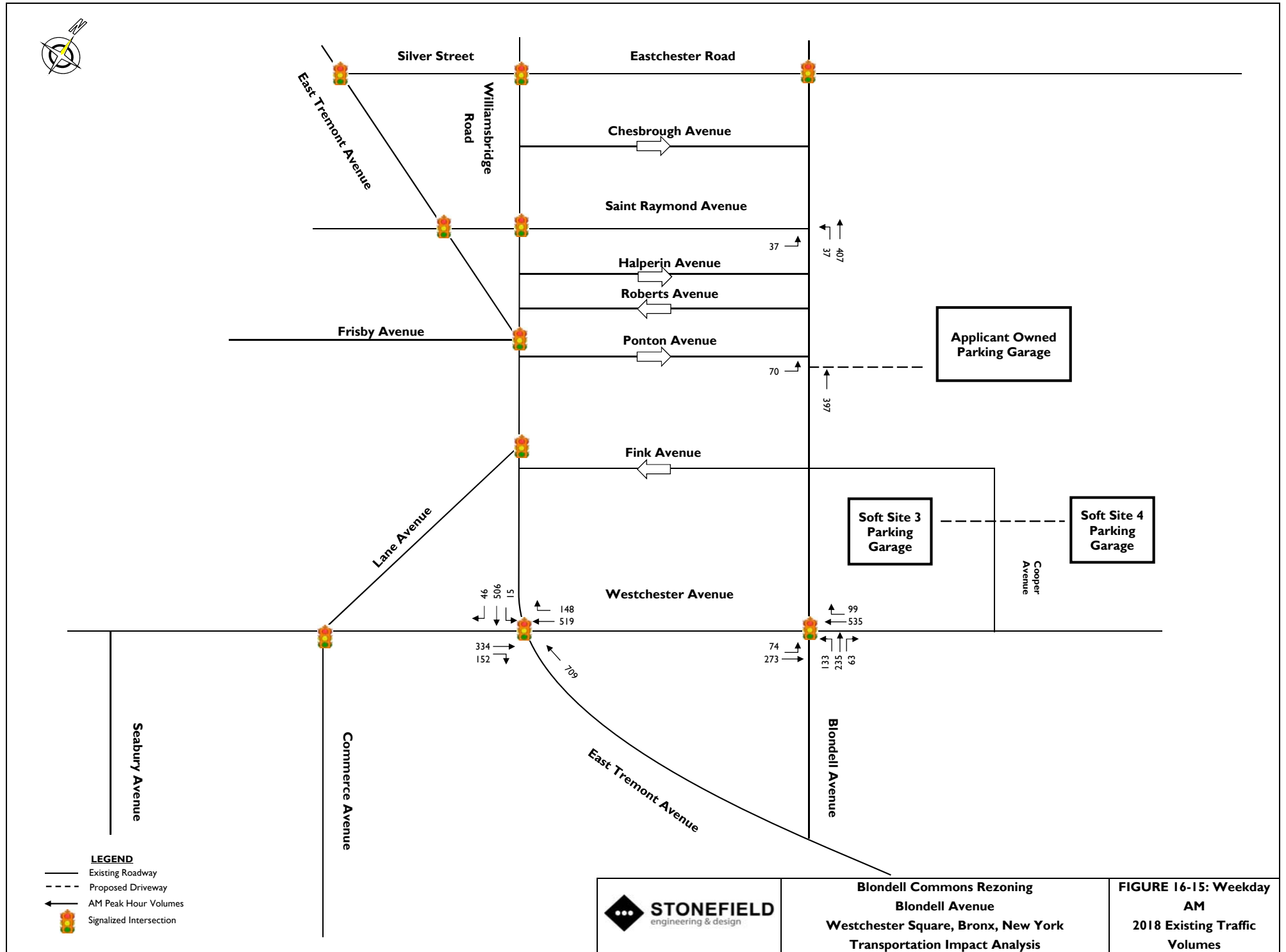

Blondell Commons Rezoning
Blondell Avenue
Westchester Square, Bronx, New York
Transportation Impact Analysis

FIGURE 16-15: Weekday AM 2018 Existing Traffic Volumes

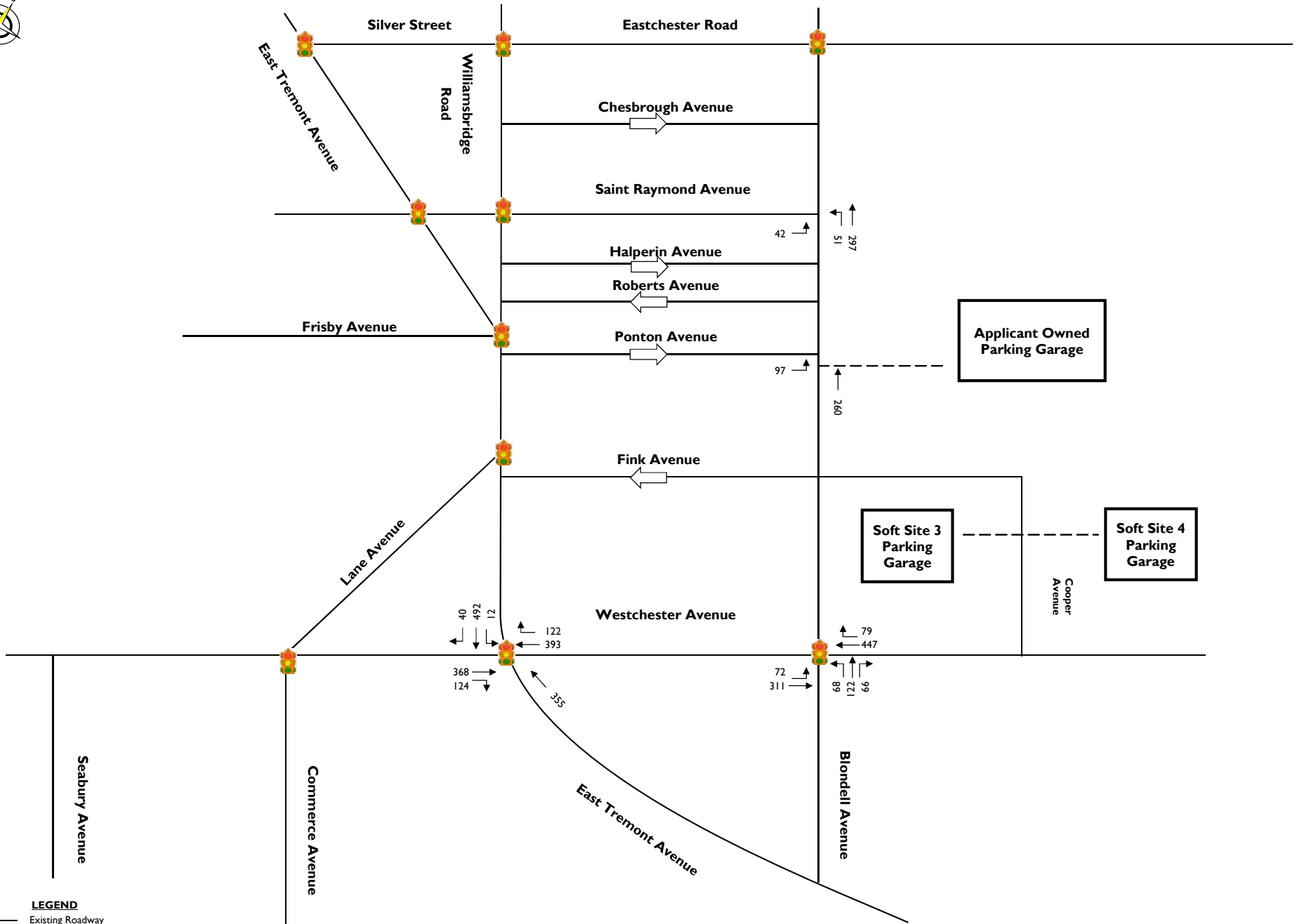

LEGEND

- Existing Roadway
- - - Proposed Driveway
- ← MID Peak Hour Volumes
- 🚦 Signalized Intersection



Blondell Commons Rezoning
Blondell Avenue
Westchester Square, Bronx, New York
Transportation Impact Analysis

FIGURE 16-16: Weekday
MID
2018 Existing Traffic
Volumes

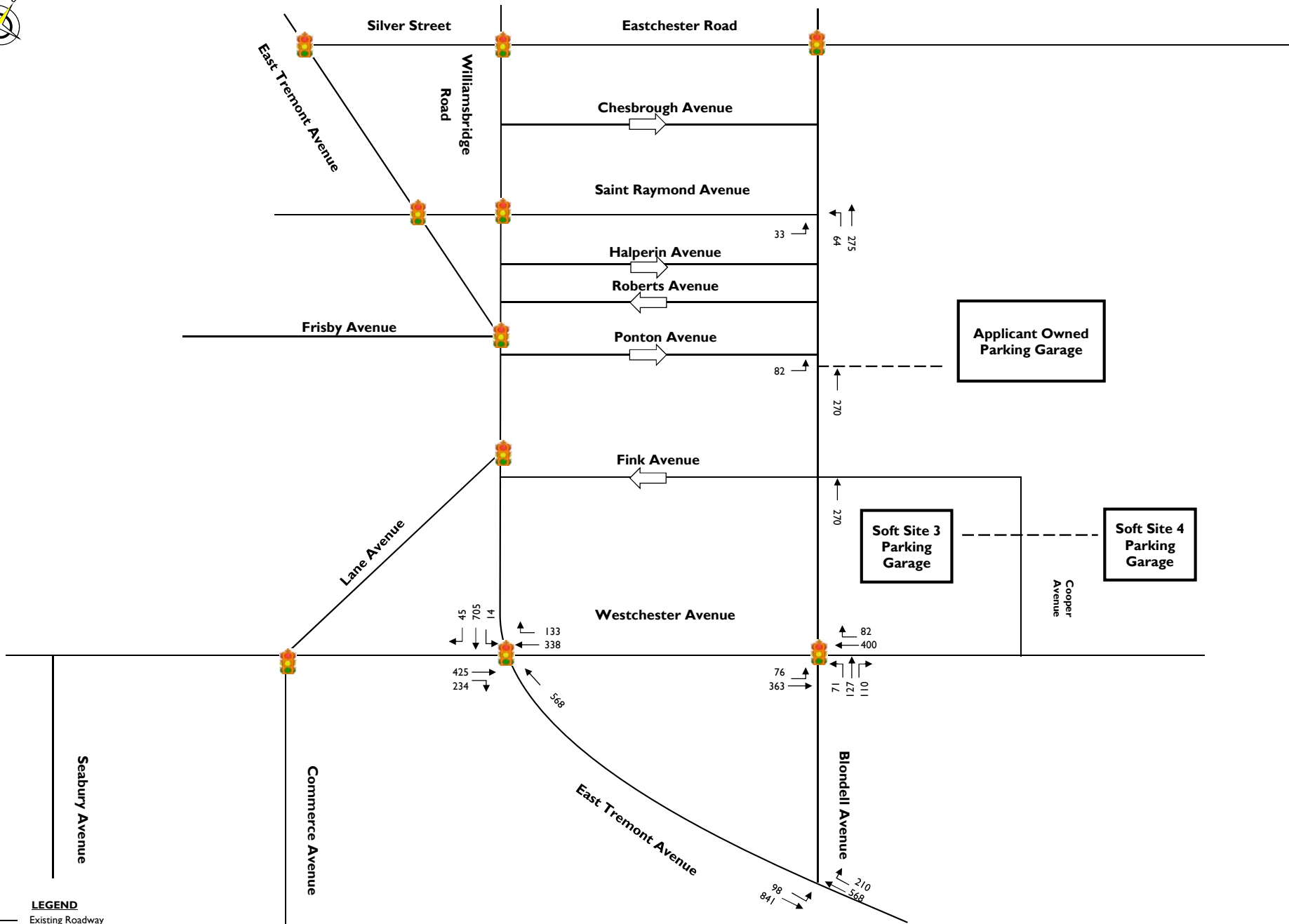

- LEGEND**
- Existing Roadway
 - Proposed Driveway
 - PM Peak Hour Volumes
 - Signalized Intersection



**Blondell Commons Rezoning
Blondell Avenue
Westchester Square, Bronx, New York
Transportation Impact Analysis**

**FIGURE 16-17: Weekday PM
2018 Existing Traffic Volumes**

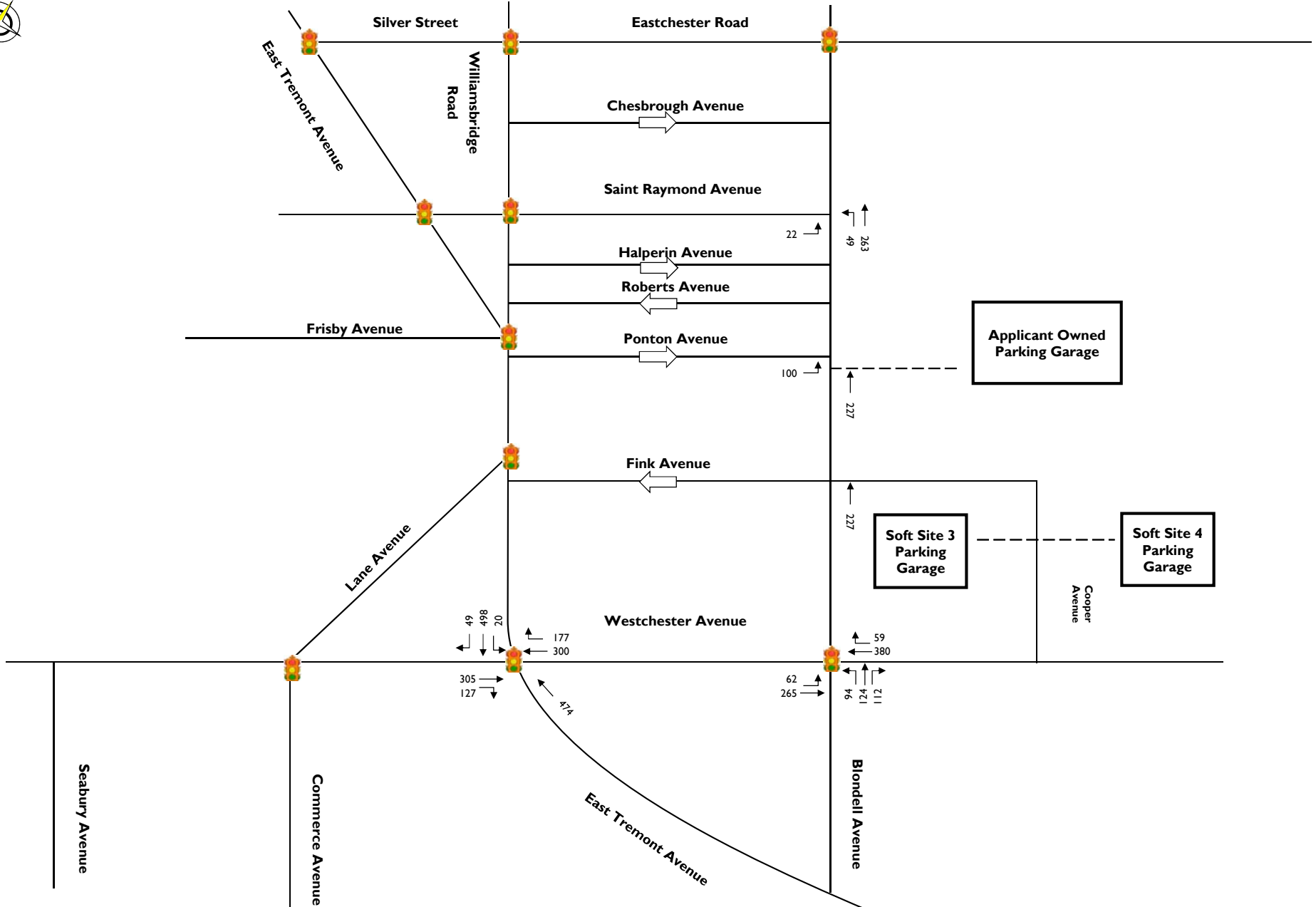

LEGEND

- Existing Roadway
- - - Proposed Driveway
- ← SAT Peak Hour Volumes
- 🚦 Signalized Intersection



**Blondell Commons Rezoning
Blondell Avenue
Westchester Square, Bronx, New York
Transportation Impact Analysis**

**FIGURE 16-18: Saturday
2018 Existing Traffic
Volumes**

**2018 EXISTING
PEDESTRIAN TRAFFIC VOLUMES**

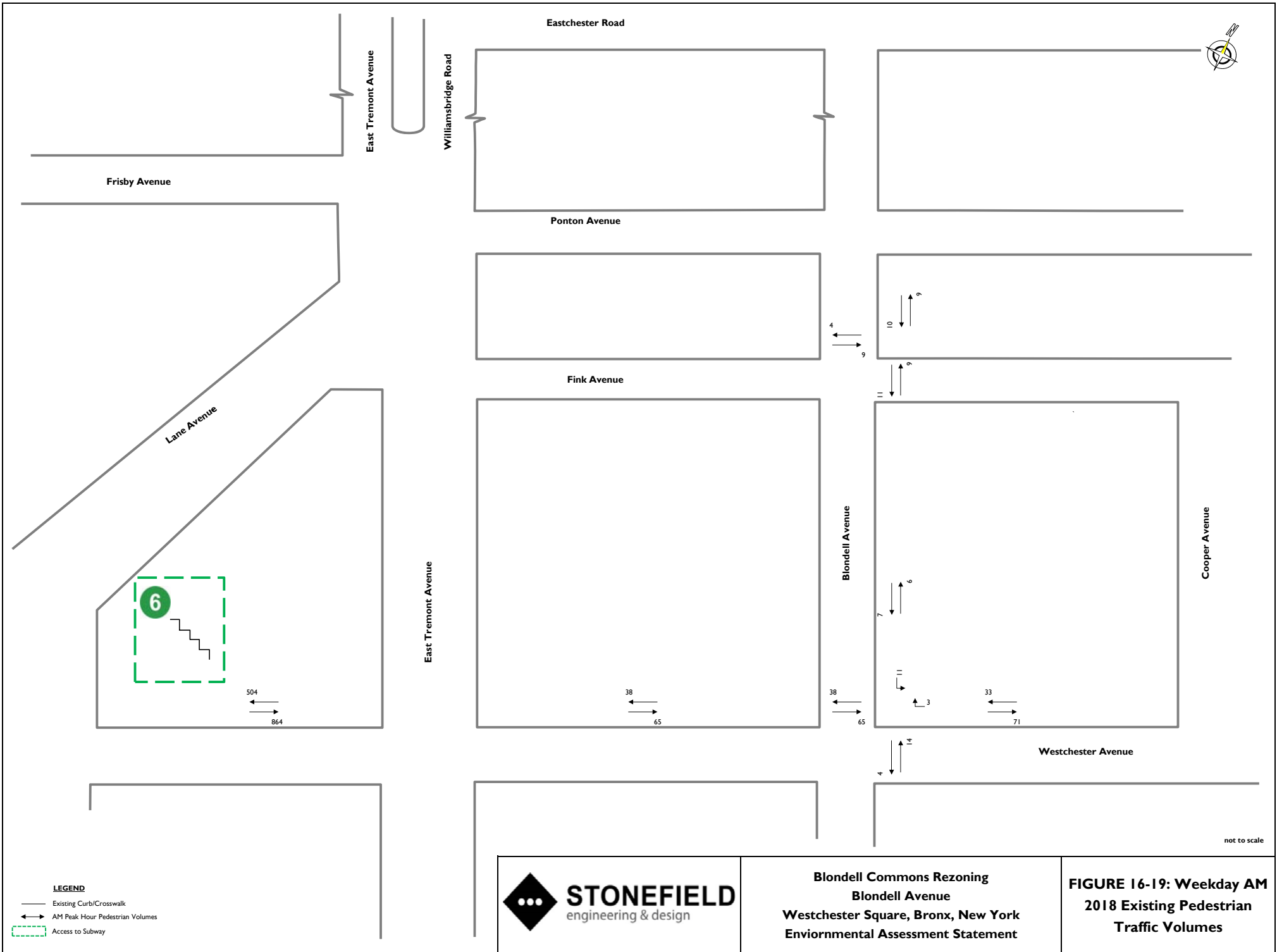

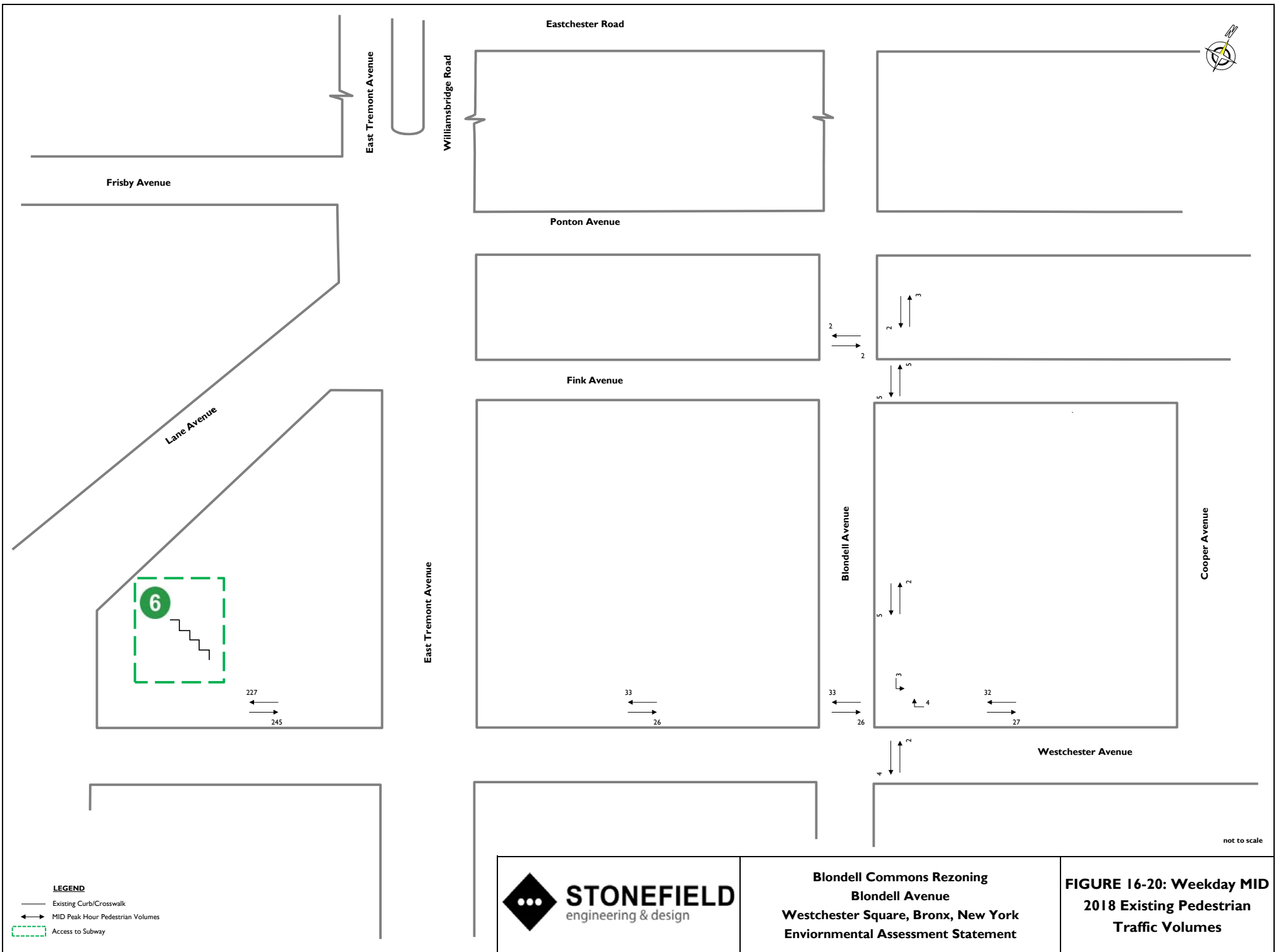

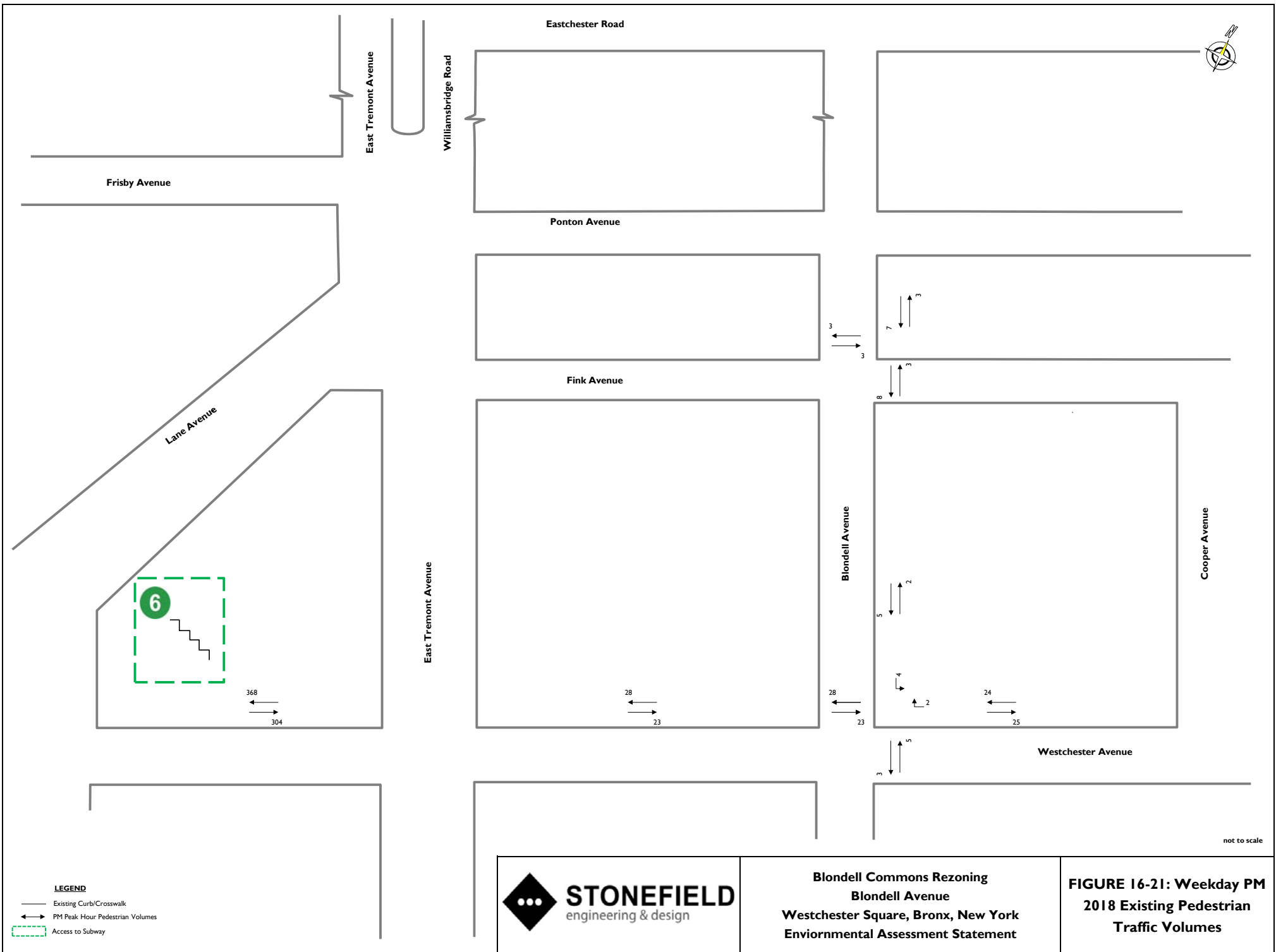

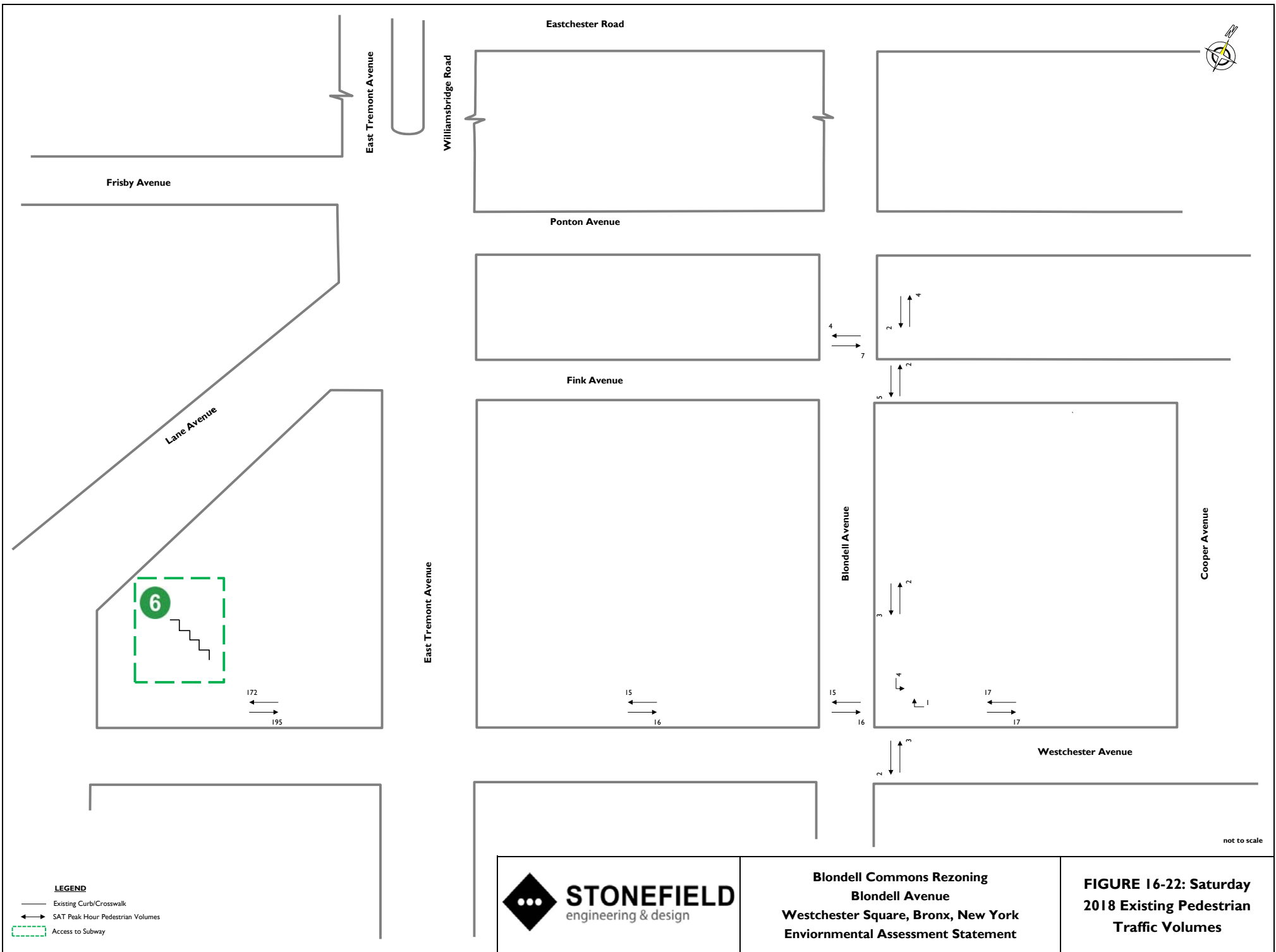

**2029 NO-ACTION
VEHICLE TRAFFIC VOLUMES**

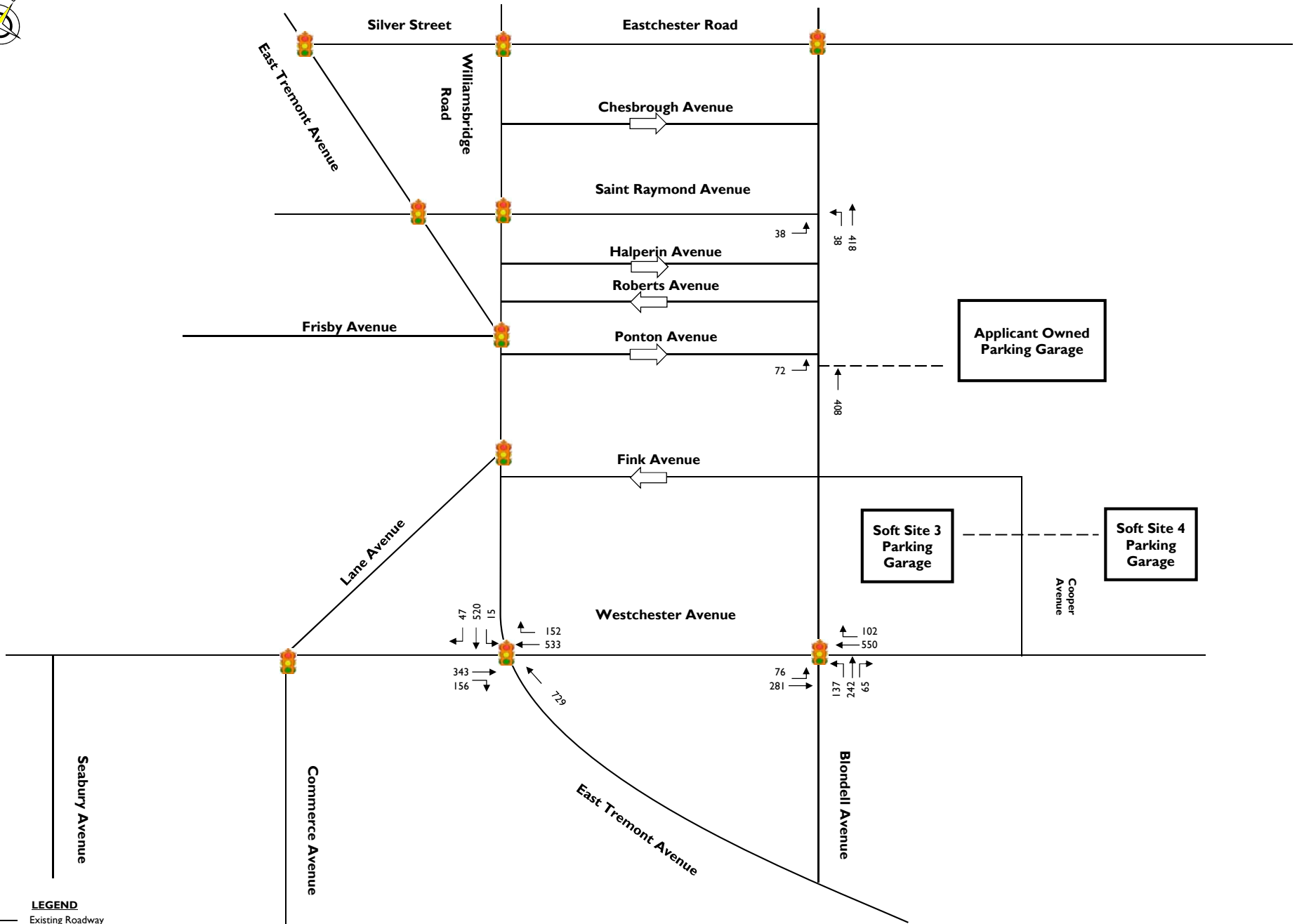

LEGEND

- Existing Roadway
- - - Proposed Driveway
- ← AM Peak Hour Volumes
- 🚦 Signalized Intersection



Blondell Commons Rezoning
Blondell Avenue
Westchester Square, Bronx, New York
Transportation Impact Analysis

FIGURE 16-23: Weekday AM 2029 No-Action Traffic Volumes

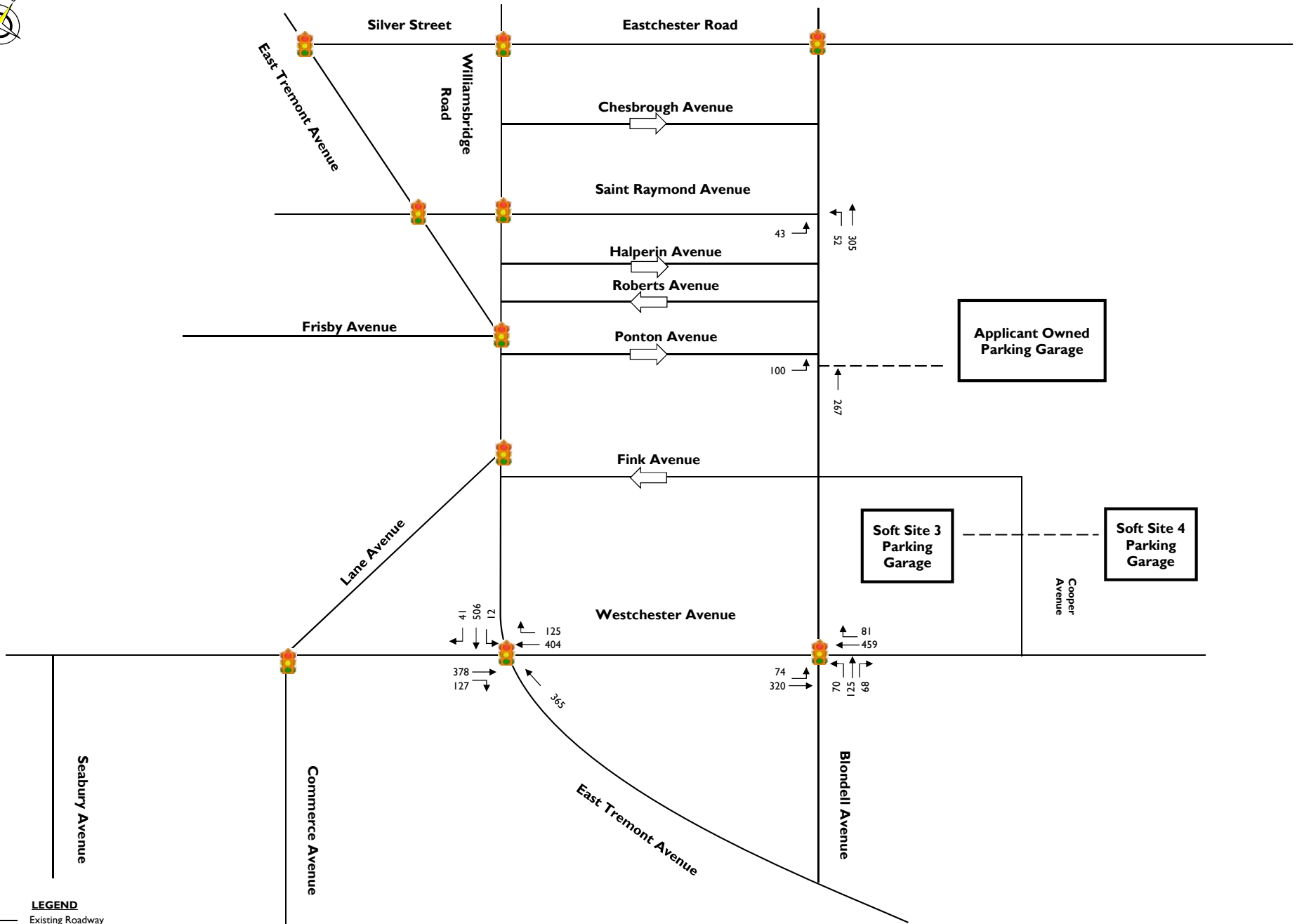

LEGEND

- Existing Roadway
- - - Proposed Driveway
- ← MID Peak Hour Volumes
- 🚦 Signalized Intersection

	<p>Blondell Commons Rezoning Blondell Avenue Westchester Square, Bronx, New York Transportation Impact Analysis</p>	<p>FIGURE 16-24: Weekday MID 2029 No-Action Traffic Volumes</p>
--	--	--

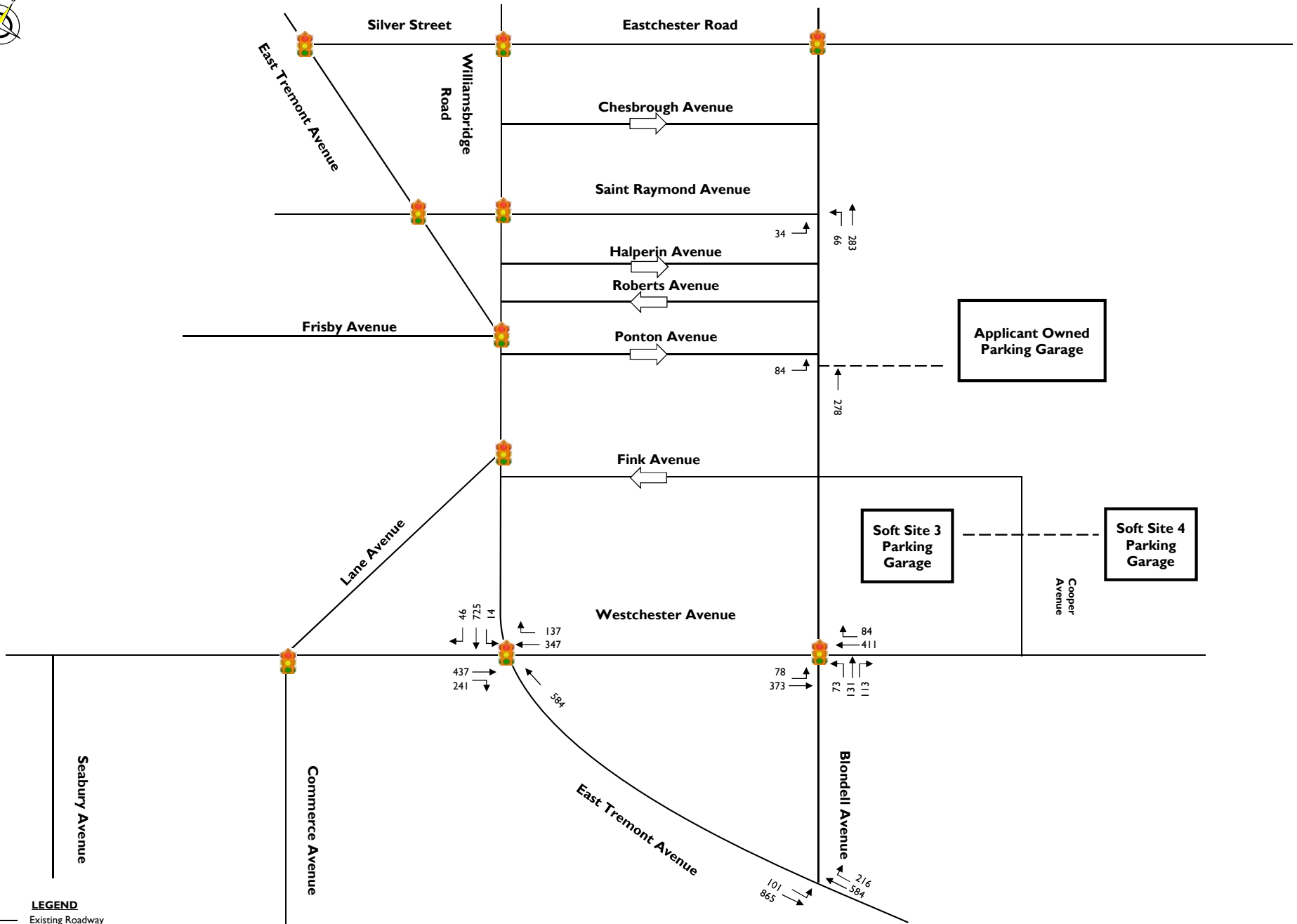

LEGEND

- Existing Roadway
- - - Proposed Driveway
- ← PM Peak Hour Volumes
- 🚦 Signalized Intersection



Blondell Commons Rezoning
Blondell Avenue
Westchester Square, Bronx, New York
Transportation Impact Analysis

FIGURE 16-25: Weekday PM
2029 No-Action Traffic Volumes

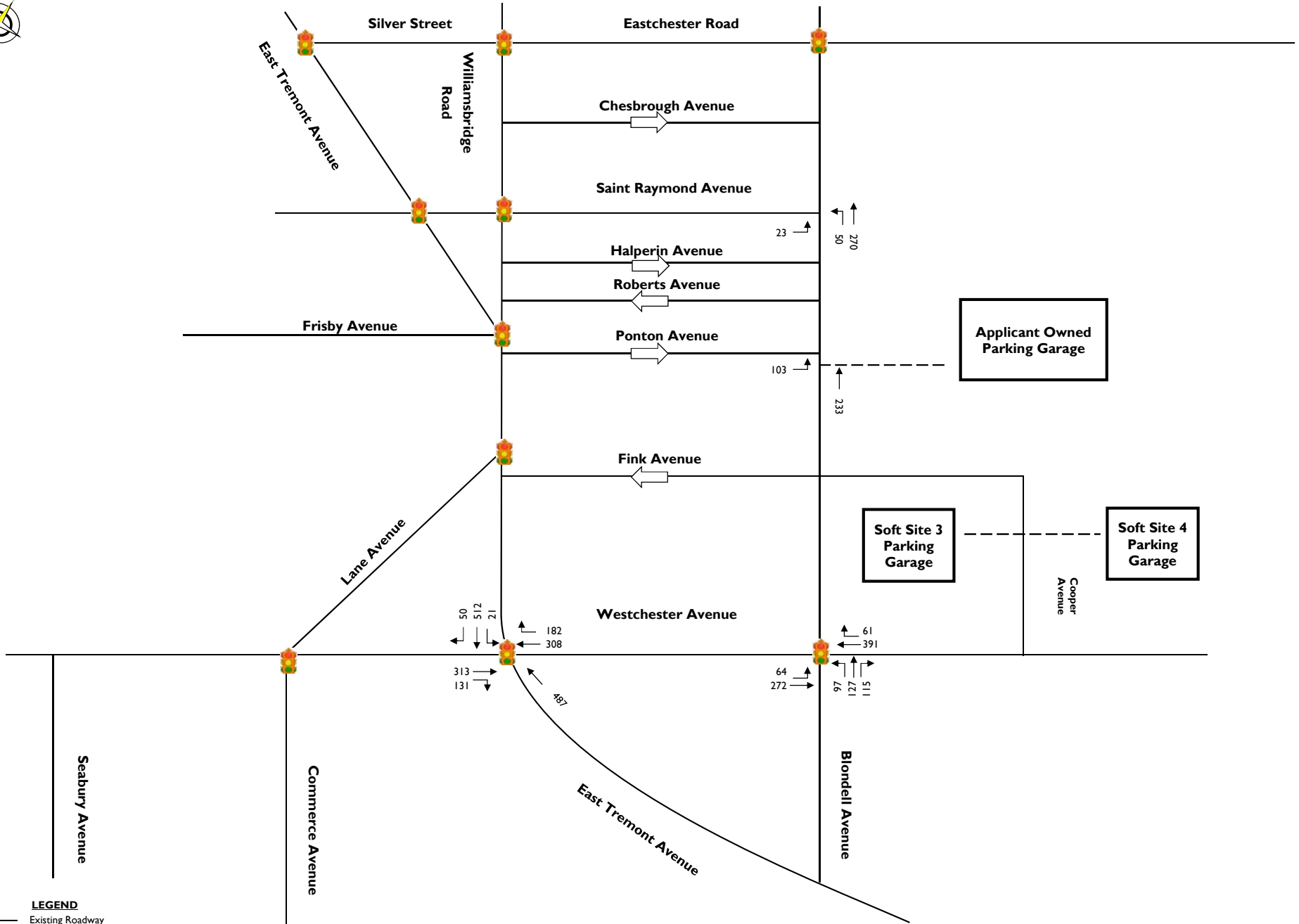

LEGEND

- Existing Roadway
- - - Proposed Driveway
- ← SAT Peak Hour Volumes
- 🚦 Signalized Intersection



Blondell Commons Rezoning
Blondell Avenue
Westchester Square, Bronx, New York
Transportation Impact Analysis

FIGURE 16-26: Saturday 2029 No-Action Traffic Volumes

**2029 NO-ACTION
PEDESTRIAN TRAFFIC VOLUMES**

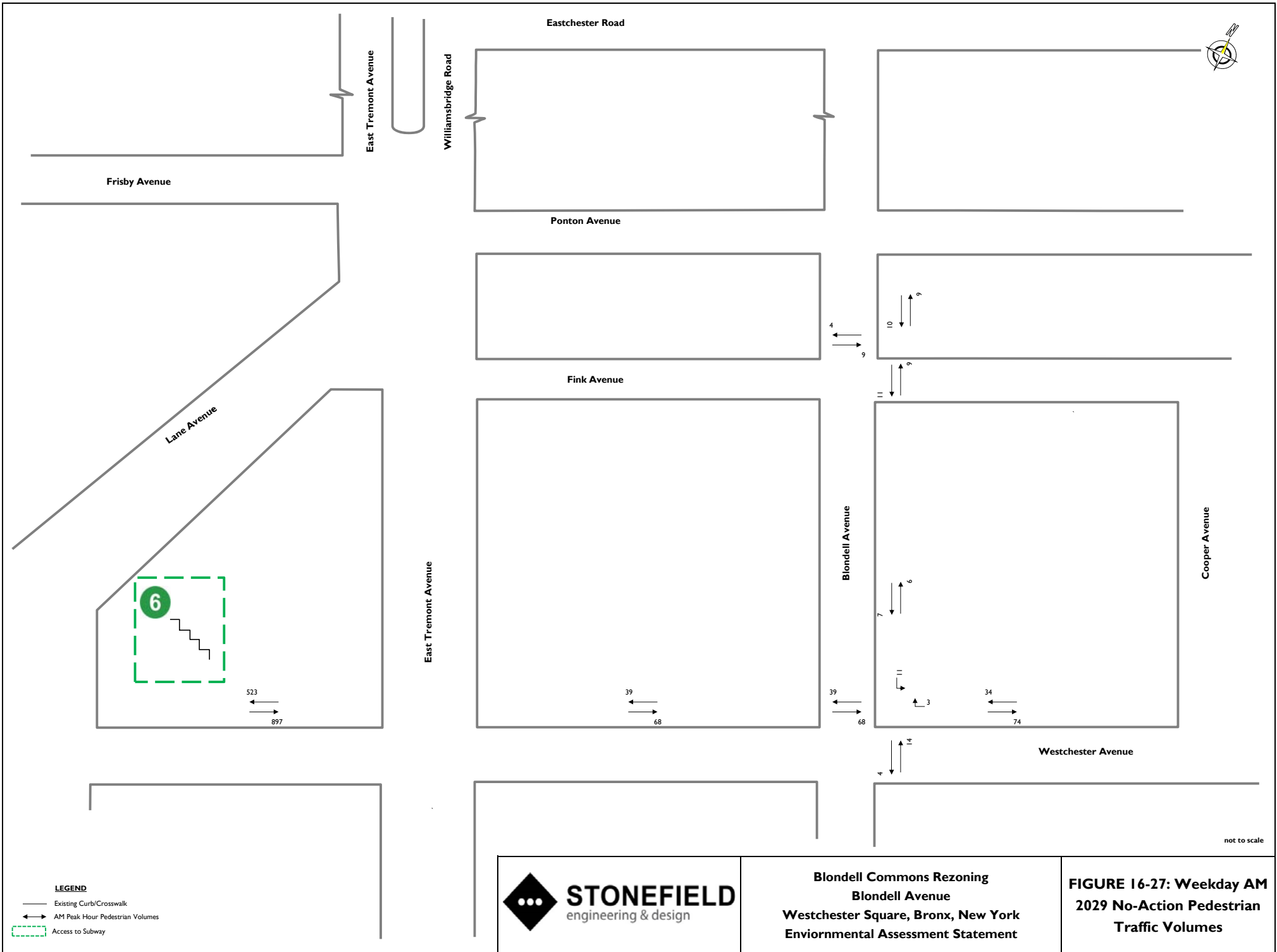

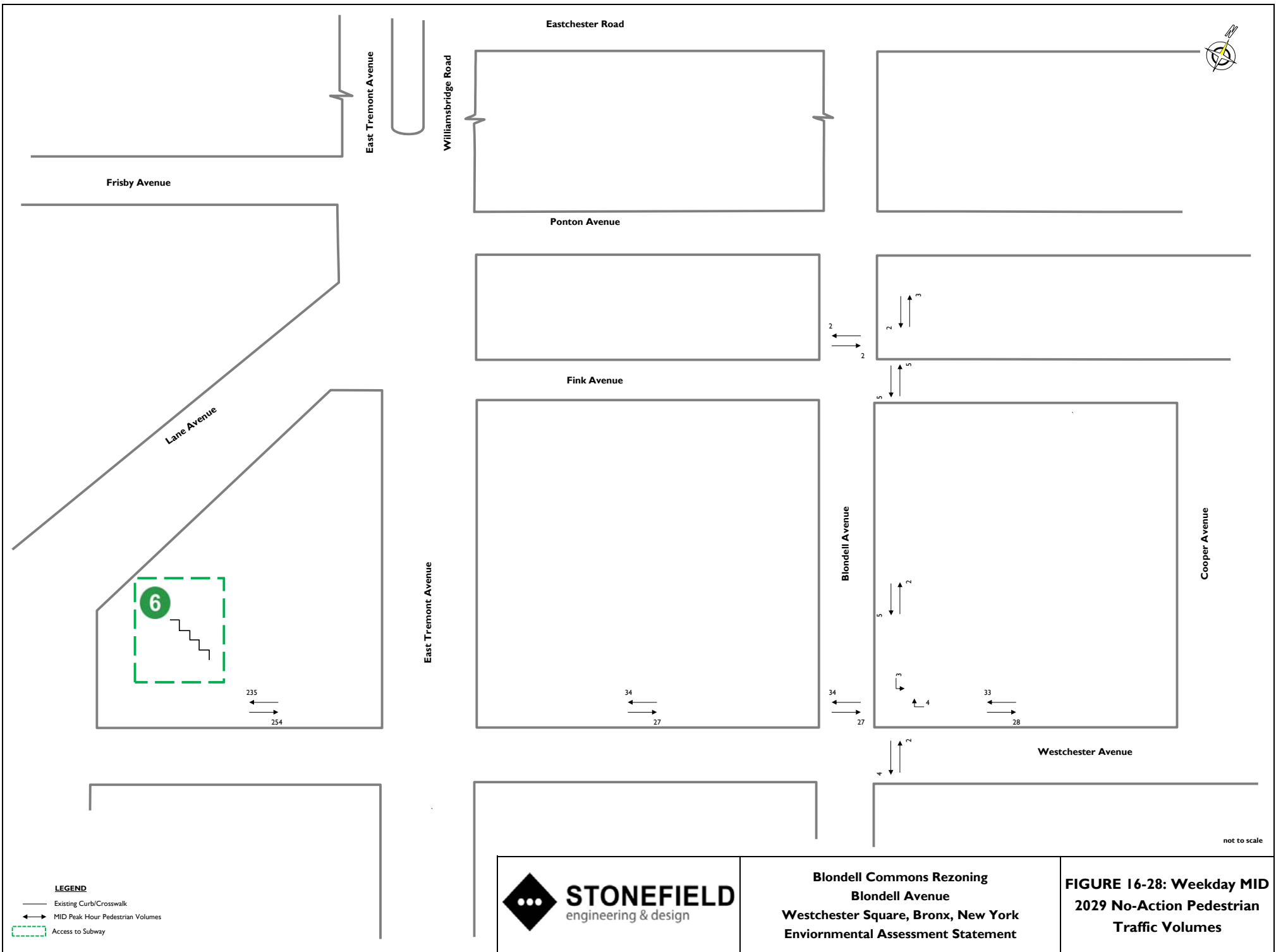

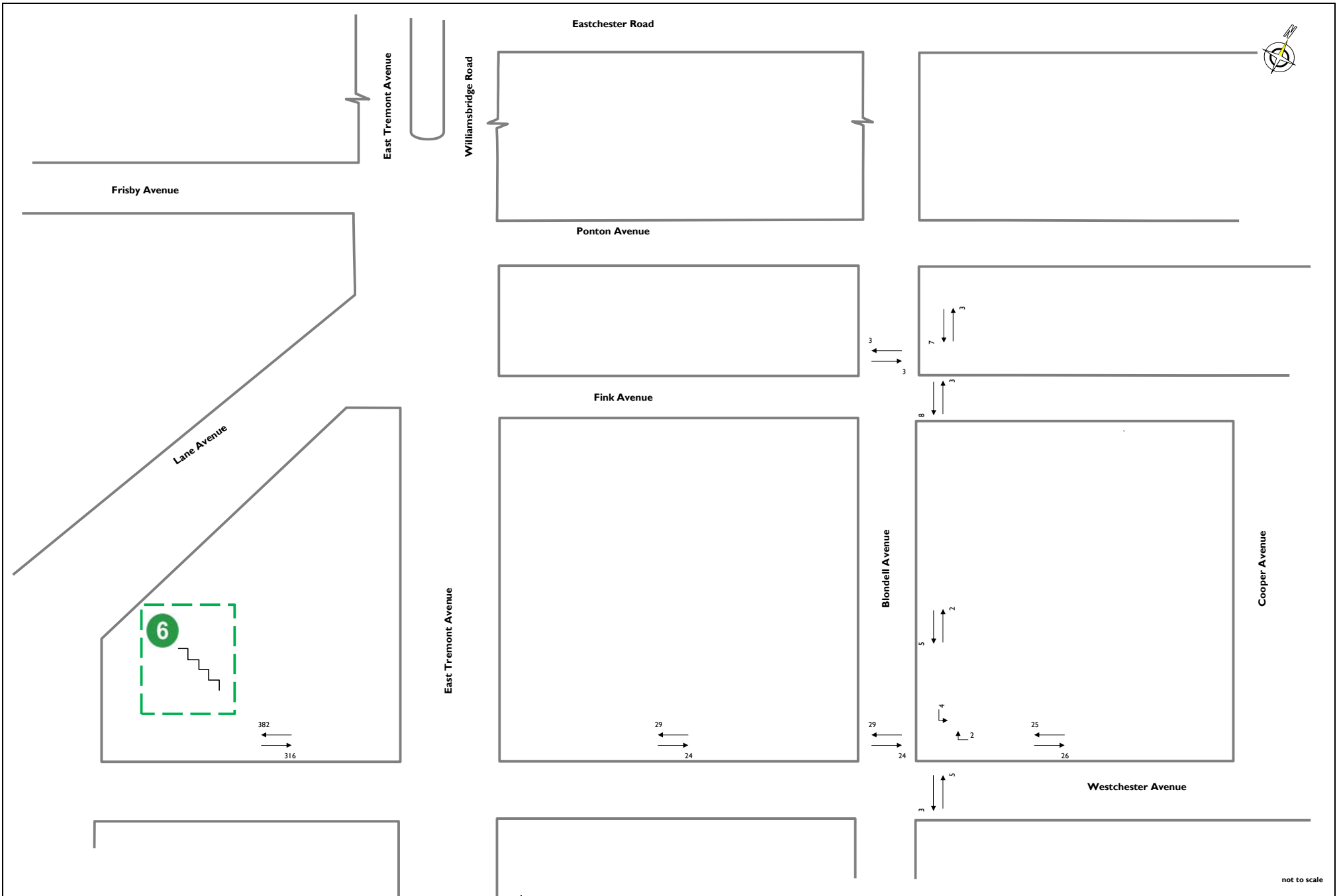

**Blondell Commons Rezoning
Blondell Avenue
Westchester Square, Bronx, New York
Environmental Assessment Statement**

**FIGURE 16-29: Weekday PM
2029 No-Action Pedestrian
Traffic Volumes**

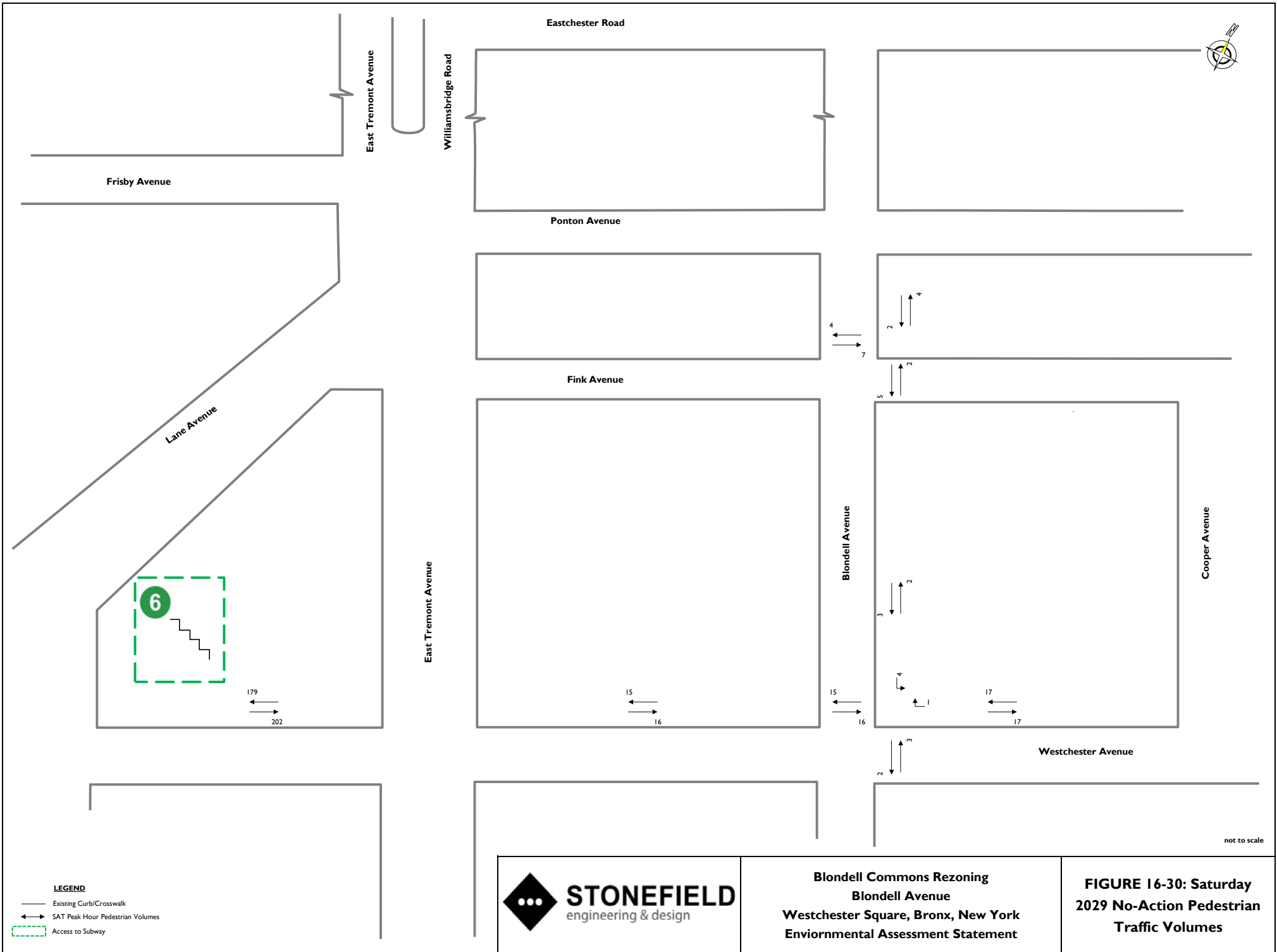

**2029 WITH-ACTION
VEHICULAR TRAFFIC VOLUMES**

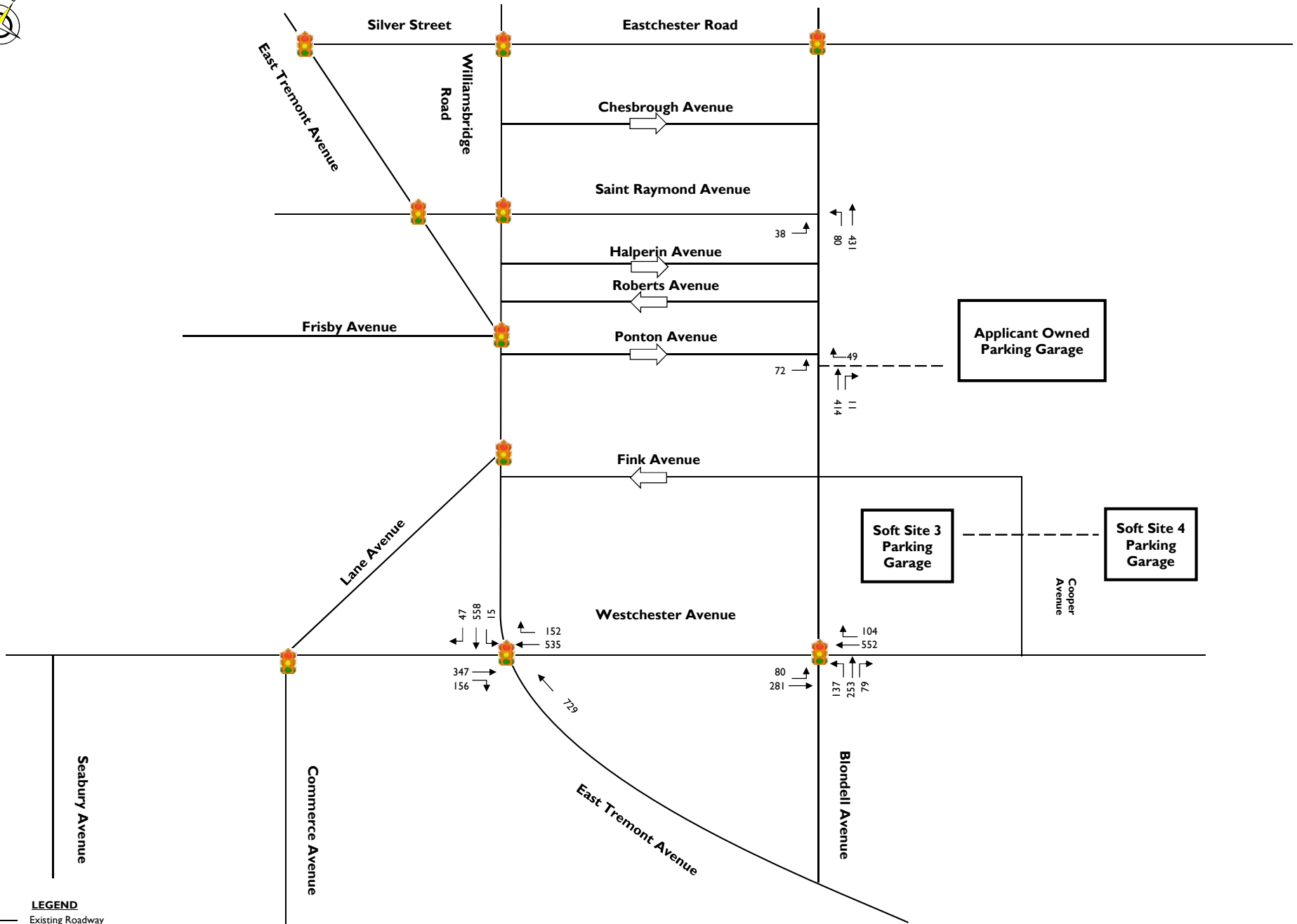

LEGEND
 — Existing Roadway
 - - - Proposed Driveway
 ← AM Peak Hour Volumes
 Signalized Intersection

	<p align="center">Blondell Commons Rezoning Blondell Avenue Westchester Square, Bronx, New York Transportation Impact Analysis</p>	<p align="center">FIGURE 16-31: Weekday AM 2029 With-Action Traffic Volumes</p>
--	---	--

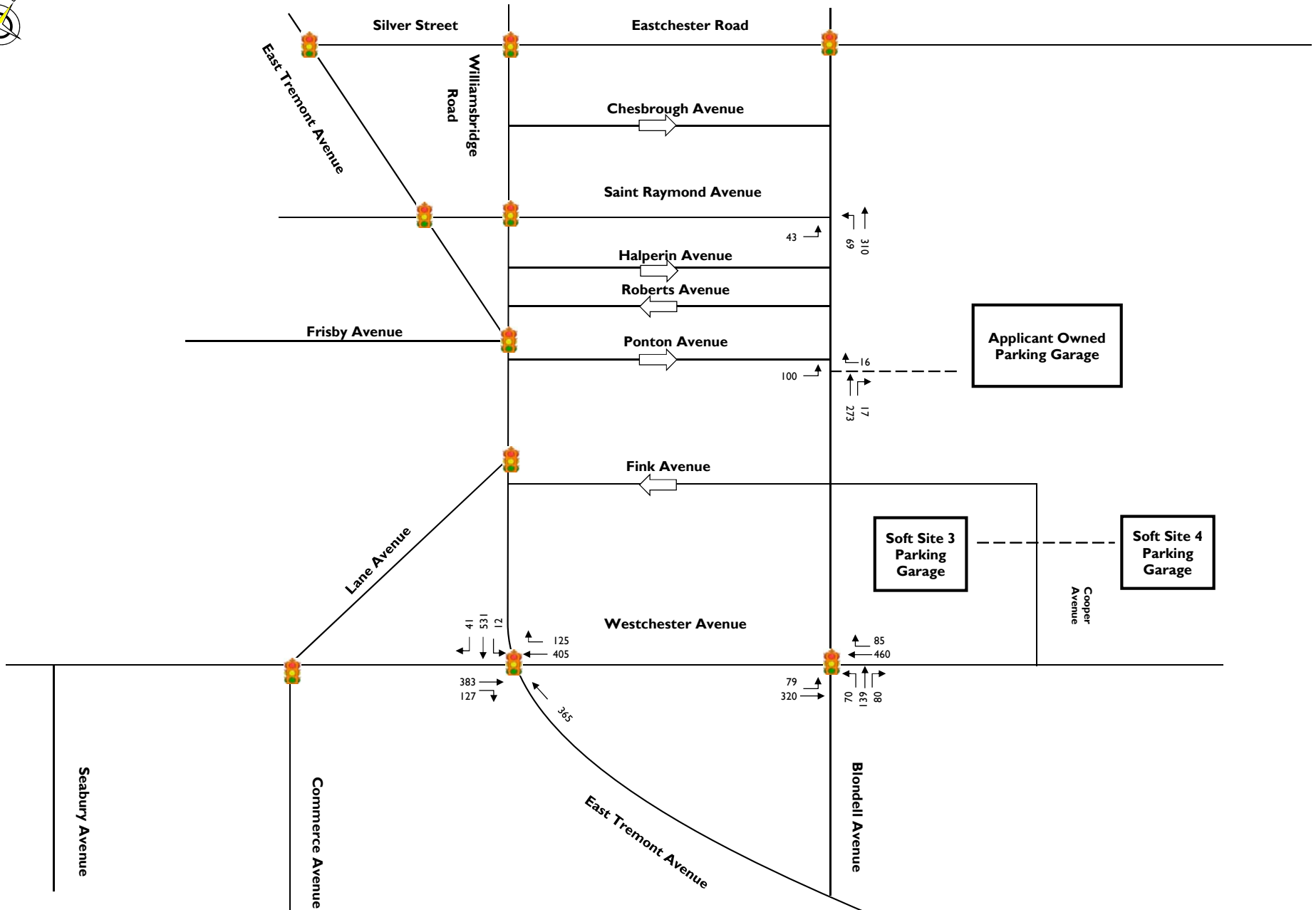

- LEGEND**
- Existing Roadway
 - - - Proposed Driveway
 - ← MID Peak Hour Volumes
 - 🚦 Signalized Intersection



Blondell Commons Rezoning
Blondell Avenue
Westchester Square, Bronx, New York
Transportation Impact Analysis

FIGURE 16-32: Weekday MID 2029 With-Action Traffic Volumes

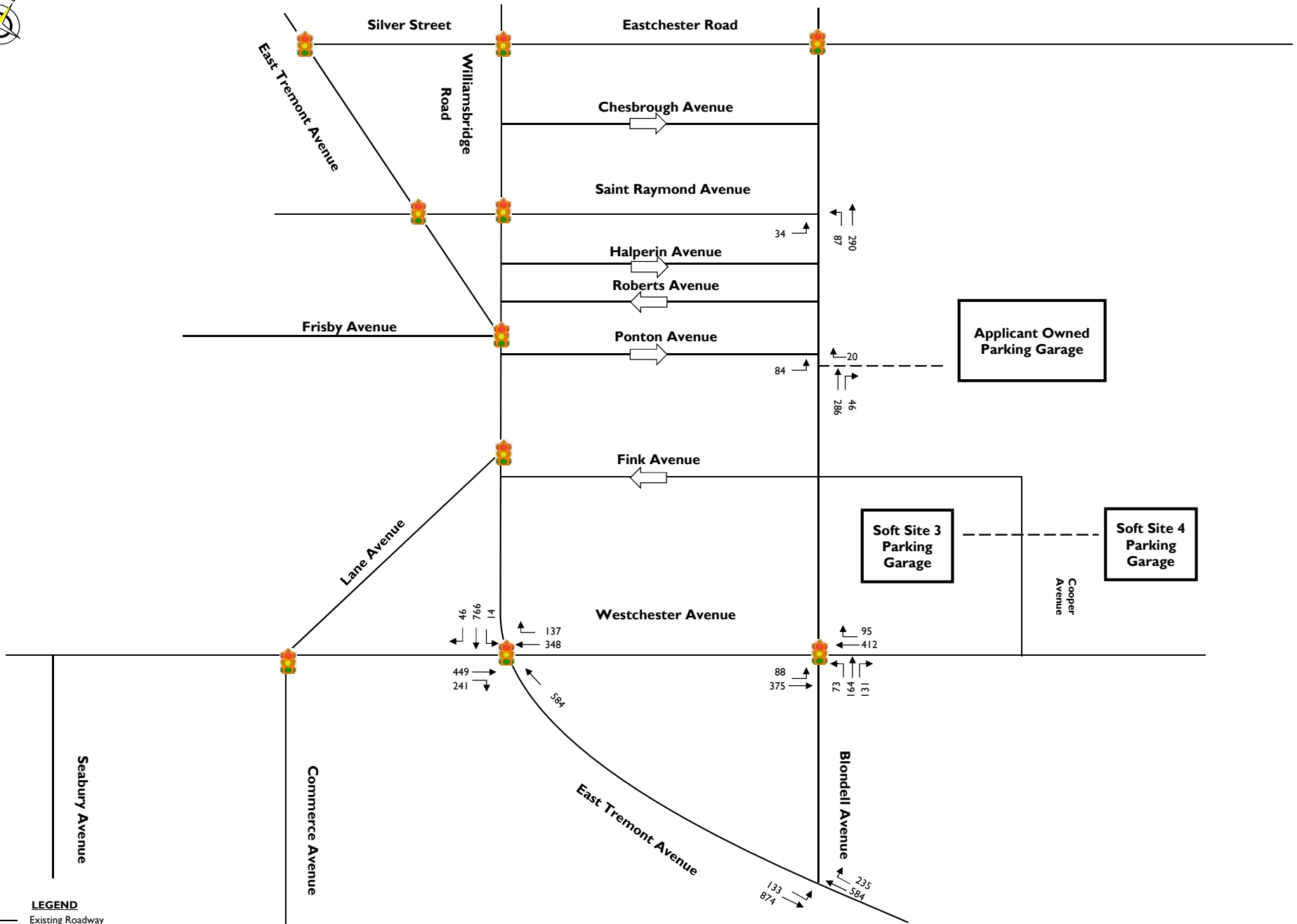

- LEGEND**
- Existing Roadway
 - - - Proposed Driveway
 - ← PM Peak Hour Volumes
 - 🚦 Signalized Intersection



Blondell Commons Rezoning
Blondell Avenue
Westchester Square, Bronx, New York
Transportation Impact Analysis

FIGURE 16-33: Weekday PM
2029 With-Action Traffic Volumes

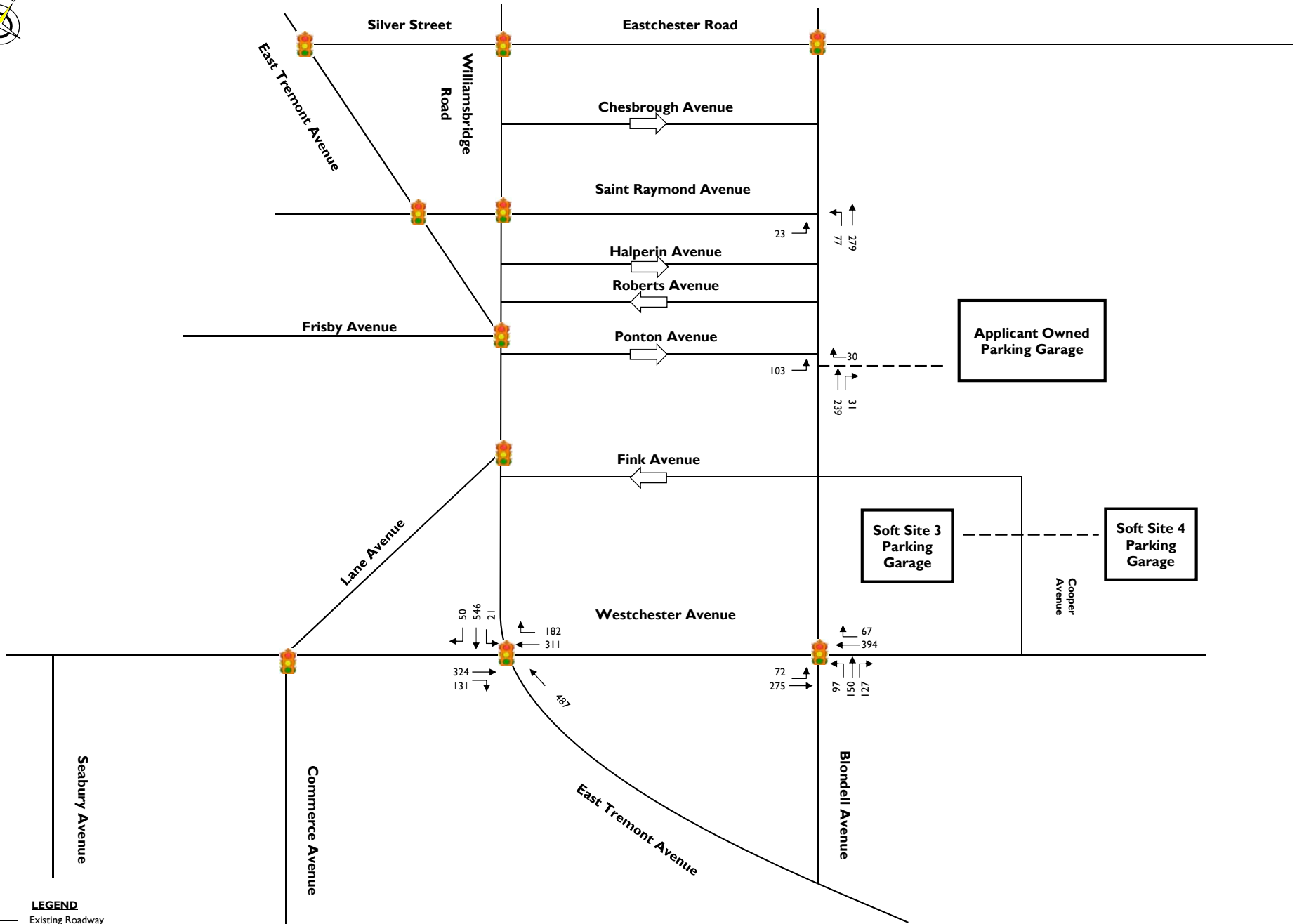

- LEGEND**
- Existing Roadway
 - Proposed Driveway
 - SAT Peak Hour Volumes
 - Signalized Intersection



Blondell Commons Rezoning
Blondell Avenue
Westchester Square, Bronx, New York
Transportation Impact Analysis

FIGURE 16-34: Saturday 2029 With-Action Traffic Volumes

**2029 WITH-ACTION
PEDESTRIAN TRAFFIC VOLUMES**

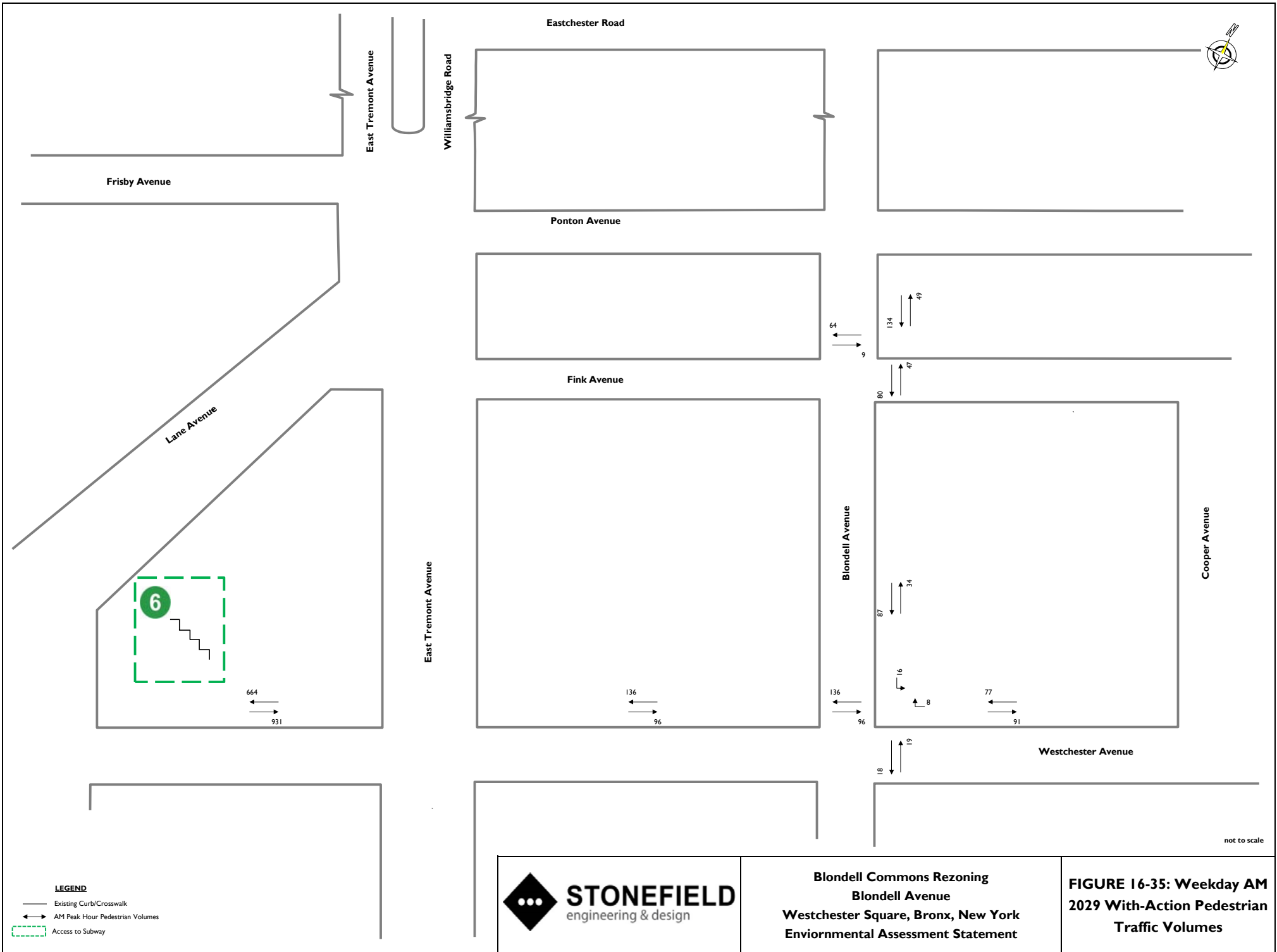

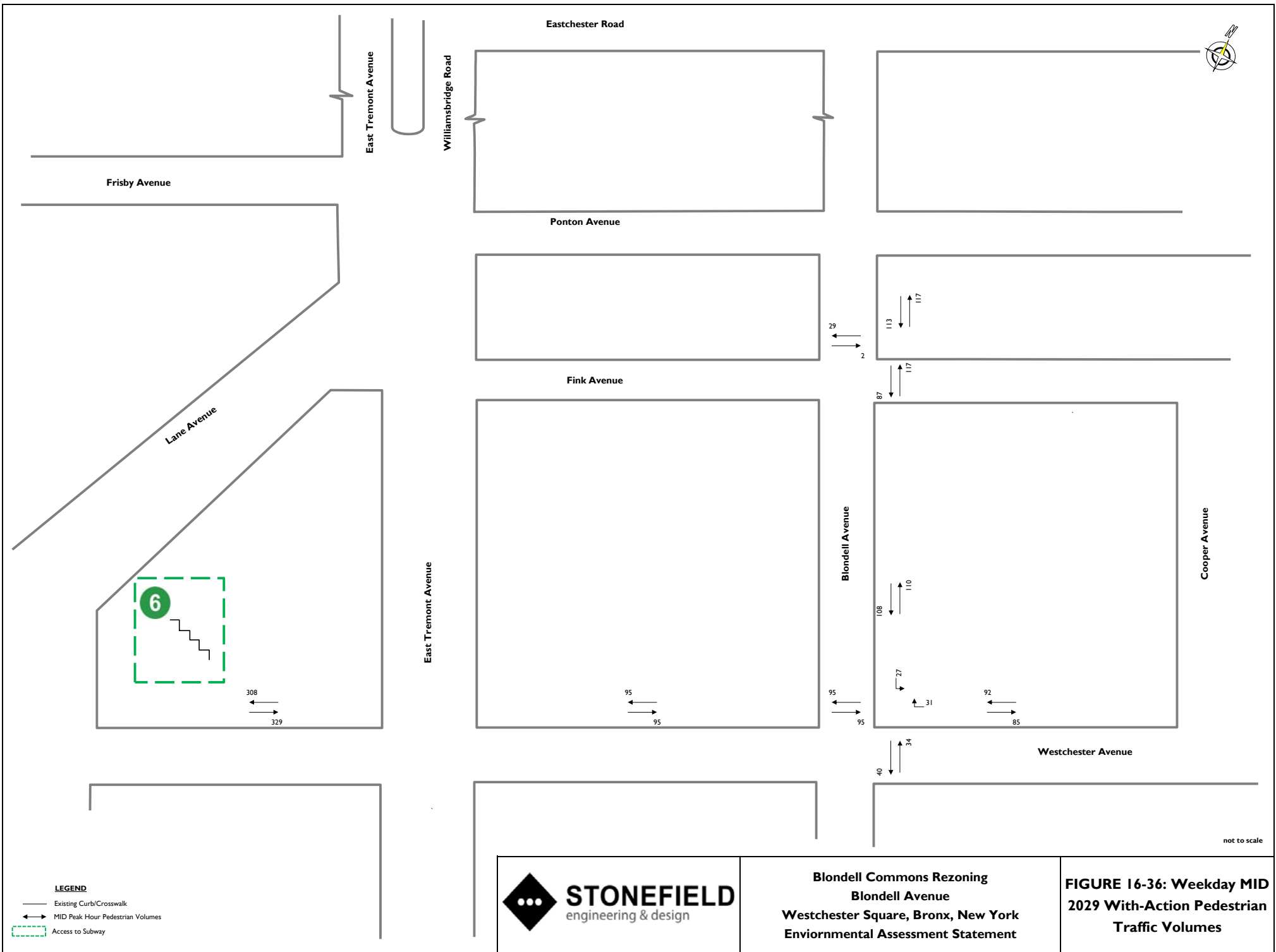

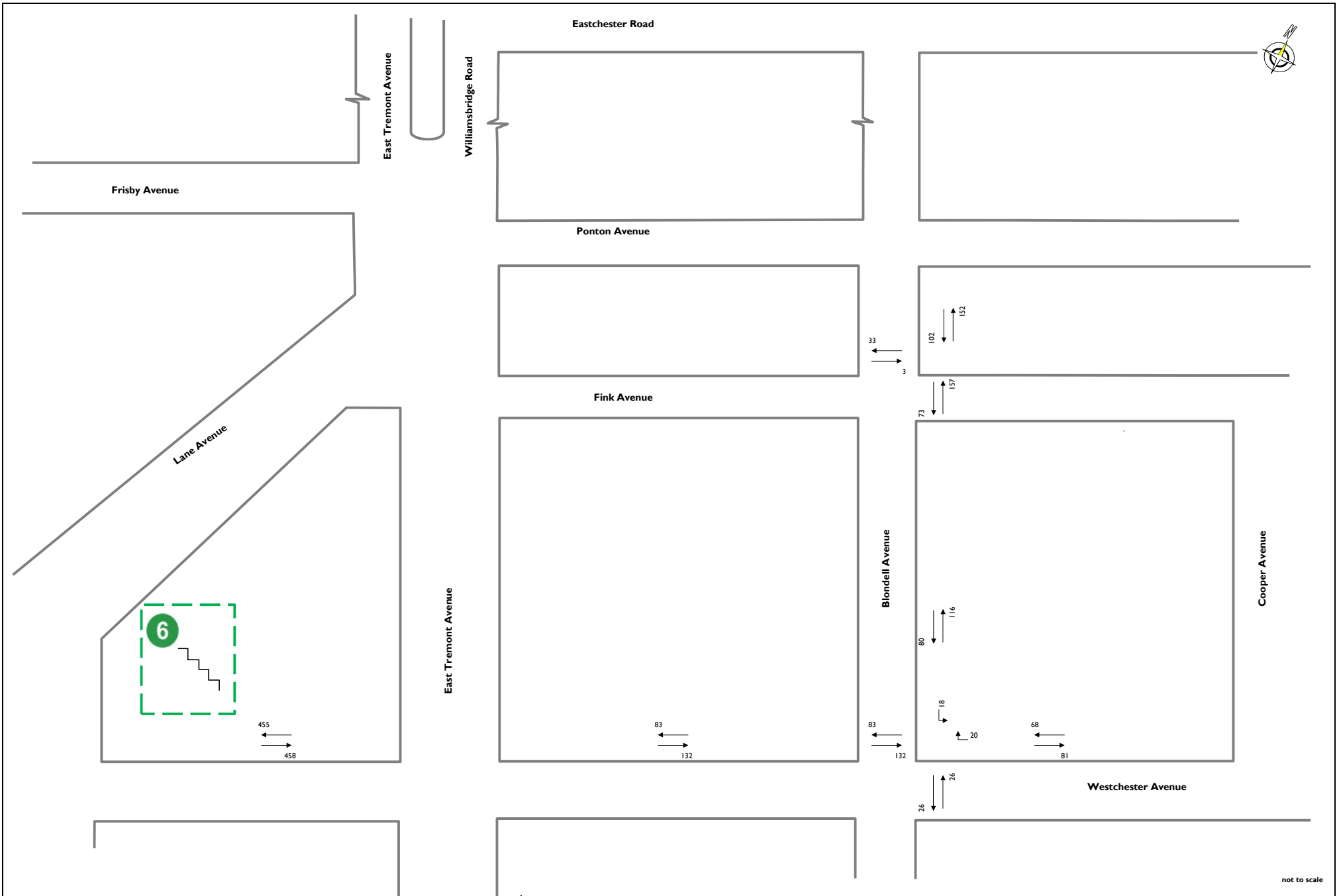

**Blondell Commons Rezoning
Blondell Avenue
Westchester Square, Bronx, New York
Environmental Assessment Statement**

**FIGURE 16-37: Weekday PM
2029 With-Action Pedestrian
Traffic Volumes**

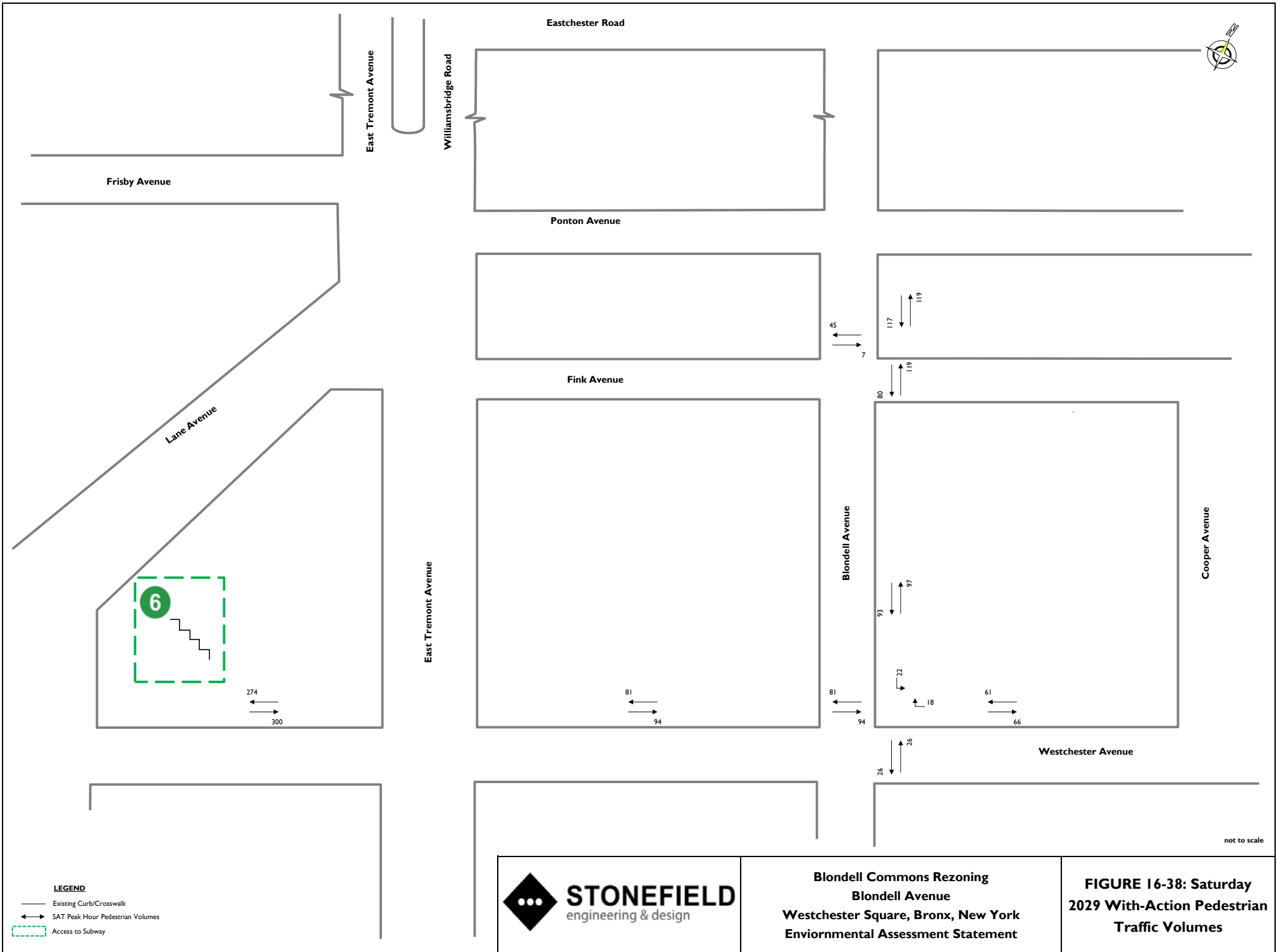

**MANUAL TURNING MOVEMENT COUNT DATA
TRAFFIC**

Stonefield Engineering & Design, LLC

27-02 41st Avenue, Long Island City, NY 11101

718.606.8305 t.

Intersection of Ponton Avenue (E/W)
and Blondell Avenue (N/S)
Bronx, New York
Saturday, November 8, 2014

File Name : L-17009 Blondell & Ponton (sat)
Site Code : 00017009
Start Date : 11/8/2014
Page No : 1

Groups Printed- Auto - HV - B/SB

Start Time	Ponton Avenue Eastbound					Ponton Avenue Westbound					Blondell Avenue Northbound					Blondell Avenue Southbound					Int. Total
	Left	Thru	Right	Peds	App. Total	Left	Thru	Right	Peds	App. Total	Left	Thru	Right	Peds	App. Total	Left	Thru	Right	Peds	App. Total	
11:00 AM	21	0	0	0	21	0	0	0	1	1	0	51	0	0	51	0	0	0	0	0	73
11:15 AM	22	0	0	0	22	0	0	0	0	0	0	42	0	0	42	0	0	0	0	0	64
11:30 AM	16	0	0	1	17	0	0	0	1	1	0	42	0	1	43	0	0	0	0	0	61
11:45 AM	22	0	0	0	22	0	0	0	0	0	0	56	0	2	58	0	0	0	0	0	80
Total	81	0	0	1	82	0	0	0	2	2	0	191	0	3	194	0	0	0	0	0	278
12:00 PM	22	0	0	4	26	0	0	0	1	1	0	58	0	2	60	0	0	0	0	0	87
12:15 PM	32	0	0	0	32	0	0	0	0	0	0	59	0	0	59	0	0	0	0	0	91
12:30 PM	22	0	0	0	22	0	0	0	1	1	0	48	0	0	48	0	0	0	0	0	71
12:45 PM	23	0	0	1	24	0	0	0	2	2	0	60	0	2	62	0	0	0	0	0	88
Total	99	0	0	5	104	0	0	0	4	4	0	225	0	4	229	0	0	0	0	0	337
01:00 PM	20	0	0	0	20	0	0	0	0	0	0	37	0	0	37	0	0	0	0	0	57
01:15 PM	16	0	0	0	16	0	0	0	0	0	0	46	0	2	48	0	0	0	0	0	64
01:30 PM	25	0	0	0	25	0	0	0	0	0	0	44	0	0	44	0	0	0	0	0	69
01:45 PM	18	0	0	0	18	0	0	0	1	1	0	45	0	1	46	0	0	0	0	0	65
Total	79	0	0	0	79	0	0	0	1	1	0	172	0	3	175	0	0	0	0	0	255
02:00 PM	12	0	0	0	12	0	0	0	0	0	0	56	0	3	59	0	0	0	0	0	71
02:15 PM	17	0	0	0	17	0	0	0	0	0	0	41	0	0	41	0	0	0	0	0	58
02:30 PM	13	0	0	0	13	0	0	0	0	0	0	54	0	0	54	0	0	0	0	0	67
02:45 PM	13	0	0	0	13	0	0	0	0	0	0	58	0	3	61	0	0	0	0	0	74
Total	55	0	0	0	55	0	0	0	0	0	0	209	0	6	215	0	0	0	0	0	270
03:00 PM	13	0	0	0	13	0	0	0	0	0	0	52	0	0	52	0	0	0	0	0	65
03:15 PM	17	0	0	0	17	0	0	0	0	0	0	52	0	2	54	0	0	0	0	0	71
03:30 PM	19	0	0	0	19	0	0	0	0	0	0	43	0	0	43	0	0	0	0	0	62
03:45 PM	15	0	0	0	15	0	0	0	0	0	0	45	0	2	47	0	0	0	0	0	62
Total	64	0	0	0	64	0	0	0	0	0	0	192	0	4	196	0	0	0	0	0	260
04:00 PM	9	0	0	0	9	0	0	0	0	0	0	44	0	0	44	0	0	0	0	0	53
04:15 PM	17	0	0	0	17	0	0	0	0	0	0	41	0	0	41	0	0	0	0	0	58
04:30 PM	14	0	0	0	14	0	0	0	0	0	0	36	0	0	36	0	0	0	0	0	50
04:45 PM	8	0	0	0	8	0	0	0	0	0	0	38	0	0	38	0	0	0	0	0	46
Total	48	0	0	0	48	0	0	0	0	0	0	159	0	0	159	0	0	0	0	0	207
Grand Total	426	0	0	6	432	0	0	0	7	7	0	1148	0	20	1168	0	0	0	0	0	1607
Apprch %	98.6	0	0	1.4		0	0	0	100		0	98.3	0	1.7		0	0	0	0		
Total %	26.5	0	0	0.4	26.9	0	0	0	0.4	0.4	0	71.4	0	1.2	72.7	0	0	0	0	0	
Auto	416	0	0	6	422	0	0	0	7	7	0	1130	0	20	1150	0	0	0	0	0	1579
% Auto	97.7	0	0	100	97.7	0	0	0	100	100	0	98.4	0	100	98.5	0	0	0	0	0	98.3
HV	9	0	0	0	9	0	0	0	0	0	0	17	0	0	17	0	0	0	0	0	26
% HV	2.1	0	0	0	2.1	0	0	0	0	0	0	1.5	0	0	1.5	0	0	0	0	0	1.6
B/SB	1	0	0	0	1	0	0	0	0	0	0	1	0	0	1	0	0	0	0	0	2
% B/SB	0.2	0	0	0	0.2	0	0	0	0	0	0	0.1	0	0	0.1	0	0	0	0	0	0.1

Stonefield Engineering & Design, LLC

27-02 41st Avenue, Long Island City, NY 11101

718.606.8305 t.

Intersection of Ponton Avenue (E/W)
and Blondell Avenue (N/S)
Bronx, New York
Saturday, November 8, 2014

File Name : L-17009 Blondell & Ponton (sat)
Site Code : 00017009
Start Date : 11/8/2014
Page No : 2

Start Time	Ponton Avenue Eastbound					Ponton Avenue Westbound					Blondell Avenue Northbound					Blondell Avenue Southbound					Int. Total
	Left	Thru	Right	Peds	App. Total	Left	Thru	Right	Peds	App. Total	Left	Thru	Right	Peds	App. Total	Left	Thru	Right	Peds	App. Total	
Peak Hour Analysis From 12:00 PM to 12:45 PM - Peak 1 of 1																					
Peak Hour for Entire Intersection Begins at 12:00 PM																					
12:00 PM	22	0	0	4	26	0	0	0	1	1	0	58	0	2	60	0	0	0	0	0	87
12:15 PM	32	0	0	0	32	0	0	0	0	0	0	59	0	0	59	0	0	0	0	0	91
12:30 PM	22	0	0	0	22	0	0	0	1	1	0	48	0	0	48	0	0	0	0	0	71
12:45 PM	23	0	0	1	24	0	0	0	2	2	0	60	0	2	62	0	0	0	0	0	88
Total Volume	99	0	0	5	104	0	0	0	4	4	0	225	0	4	229	0	0	0	0	0	337
% App. Total	95.2	0	0	4.8		0	0	0	100		0	98.3	0	1.7		0	0	0	0		
PHF	.773	.000	.000	.313	.813	.000	.000	.000	.500	.500	.000	.938	.000	.500	.923	.000	.000	.000	.000	.000	.926
Auto	96	0	0	5	101	0	0	0	4	4	0	222	0	4	226	0	0	0	0	0	331
% Auto	97.0	0	0	100	97.1	0	0	0	100	100	0	98.7	0	100	98.7	0	0	0	0	0	98.2
HV	3	0	0	0	3	0	0	0	0	0	0	3	0	0	3	0	0	0	0	0	6
% HV	3.0	0	0	0	2.9	0	0	0	0	0	0	1.3	0	0	1.3	0	0	0	0	0	1.8
B/SB	0	0	0	0	0	0	0	0	0	0	0	0	0	0	0	0	0	0	0	0	0
% B/SB	0	0	0	0	0	0	0	0	0	0	0	0	0	0	0	0	0	0	0	0	0

Stonefield Engineering & Design, LLC

27-02 41st Avenue, Long Island City, NY 11101

718.606.8305 t.

Intersection of Ponton Avenue (E/W)
and Blondell Avenue (N/S)
Bronx, New York
Wednesday, November 12, 2014

File Name : L-17009 Blondell & Ponton (wkdy)
Site Code : 00017009
Start Date : 11/12/2014
Page No : 1

Groups Printed- Auto - HV - B/SB

Start Time	Ponton Avenue Eastbound					Ponton Avenue Westbound					Blondell Avenue Northbound					Blondell Avenue Southbound					Int. Total
	Left	Thru	Right	Peds	App. Total	Left	Thru	Right	Peds	App. Total	Left	Thru	Right	Peds	App. Total	Left	Thru	Right	Peds	App. Total	
07:00 AM	6	0	0	0	6	0	0	0	0	0	0	67	0	1	68	0	0	0	0	0	74
07:15 AM	4	0	0	1	5	0	0	0	0	0	0	81	0	1	82	0	0	0	0	0	87
07:30 AM	9	0	0	0	9	0	0	0	1	1	0	87	0	0	87	0	0	0	0	0	97
07:45 AM	8	0	0	2	10	0	0	0	2	2	0	104	0	2	106	0	0	0	0	0	118
Total	27	0	0	3	30	0	0	0	3	3	0	339	0	4	343	0	0	0	0	0	376
08:00 AM	23	0	0	0	23	0	0	0	1	1	0	93	0	1	94	0	0	0	0	0	118
08:15 AM	20	0	0	1	21	0	0	0	0	0	0	109	0	3	112	0	0	0	0	0	133
08:30 AM	18	0	0	0	18	0	0	0	0	0	0	87	0	0	87	0	0	0	0	0	105
08:45 AM	13	0	0	0	13	0	0	0	0	0	0	92	0	3	95	0	0	0	0	0	108
Total	74	0	0	1	75	0	0	0	1	1	0	381	0	7	388	0	0	0	0	0	464
09:00 AM	21	0	0	0	21	0	0	0	2	2	0	69	0	2	71	0	0	0	0	0	94
09:15 AM	17	0	0	0	17	0	0	0	3	3	0	72	0	0	72	0	0	0	0	0	92
09:30 AM	18	0	0	0	18	0	0	0	0	0	0	57	0	2	59	0	0	0	0	0	77
09:45 AM	19	0	0	0	19	0	0	0	0	0	0	57	0	0	57	0	0	0	0	0	76
Total	75	0	0	0	75	0	0	0	5	5	0	255	0	4	259	0	0	0	0	0	339
*** BREAK ***																					
11:00 AM	31	0	0	0	31	0	0	0	3	3	0	49	0	2	51	0	0	0	0	0	85
11:15 AM	21	0	0	0	21	0	0	0	2	2	0	57	0	0	57	0	0	0	0	0	80
11:30 AM	22	0	0	0	22	0	0	0	1	1	0	53	0	0	53	0	0	0	0	0	76
11:45 AM	22	0	0	0	22	0	0	0	0	0	0	52	0	2	54	0	0	0	0	0	76
Total	96	0	0	0	96	0	0	0	6	6	0	211	0	4	215	0	0	0	0	0	317
12:00 PM	18	0	0	0	18	0	0	0	0	0	0	63	0	1	64	0	0	0	0	0	82
12:15 PM	28	0	0	0	28	0	0	0	0	0	0	65	0	2	67	0	0	0	0	0	95
12:30 PM	28	0	0	0	28	0	0	0	0	0	0	64	0	2	66	0	0	0	0	0	94
12:45 PM	22	0	0	0	22	0	0	0	1	1	0	65	0	5	70	0	0	0	0	0	93
Total	96	0	0	0	96	0	0	0	1	1	0	257	0	10	267	0	0	0	0	0	364
01:00 PM	15	0	0	0	15	0	0	0	0	0	0	54	0	1	55	0	0	0	0	0	70
01:15 PM	20	0	0	0	20	0	0	0	0	0	0	63	0	4	67	0	0	0	0	0	87
01:30 PM	19	0	0	0	19	0	0	0	1	1	0	54	0	3	57	0	0	0	0	0	77
01:45 PM	18	0	0	0	18	0	0	0	0	0	0	54	0	2	56	0	0	0	0	0	74
Total	72	0	0	0	72	0	0	0	1	1	0	225	0	10	235	0	0	0	0	0	308
*** BREAK ***																					
04:00 PM	26	0	0	0	26	0	0	0	0	0	0	68	0	2	70	0	0	0	0	0	96
04:15 PM	28	0	0	0	28	0	0	0	0	0	0	63	0	0	63	0	0	0	0	0	91
04:30 PM	31	0	0	0	31	0	0	0	0	0	0	84	0	0	84	0	0	0	0	0	115
04:45 PM	24	0	0	0	24	0	0	0	0	0	0	63	0	0	63	0	0	0	0	0	87
Total	109	0	0	0	109	0	0	0	0	0	0	278	0	2	280	0	0	0	0	0	389

Stonefield Engineering & Design, LLC

27-02 41st Avenue, Long Island City, NY 11101
718.606.8305 t.

Intersection of Ponton Avenue (E/W)
and Blondell Avenue (N/S)
Bronx, New York
Wednesday, November 12, 2014

File Name : L-17009 Blondell & Ponton (wkdy)
Site Code : 00017009
Start Date : 11/12/2014
Page No : 2

Groups Printed- Auto - HV - B/SB

Start Time	Ponton Avenue Eastbound					Ponton Avenue Westbound					Blondell Avenue Northbound					Blondell Avenue Southbound					Int. Total
	Left	Thru	Right	Peds	App. Total	Left	Thru	Right	Peds	App. Total	Left	Thru	Right	Peds	App. Total	Left	Thru	Right	Peds	App. Total	
05:00 PM	12	0	0	0	12	0	0	0	0	0	0	63	0	0	63	0	0	0	0	0	75
05:15 PM	14	0	0	0	14	0	0	0	0	0	0	57	0	0	57	0	0	0	0	0	71
05:30 PM	10	0	0	0	10	0	0	0	0	0	0	66	0	0	66	0	0	0	0	0	76
05:45 PM	12	0	0	0	12	0	0	0	0	0	0	44	0	0	44	0	0	0	0	0	56
Total	48	0	0	0	48	0	0	0	0	0	0	230	0	0	230	0	0	0	0	0	278
Grand Total	597	0	0	4	601	0	0	0	17	17	0	2176	0	41	2217	0	0	0	0	0	2835
Apprch %	99.3	0	0	0.7		0	0	0	100		0	98.2	0	1.8		0	0	0	0		
Total %	21.1	0	0	0.1	21.2	0	0	0	0.6	0.6	0	76.8	0	1.4	78.2	0	0	0	0	0	
Auto	572	0	0	4	576	0	0	0	17	17	0	2128	0	41	2169	0	0	0	0	0	2762
% Auto	95.8	0	0	100	95.8	0	0	0	100	100	0	97.8	0	100	97.8	0	0	0	0	0	97.4
HV	20	0	0	0	20	0	0	0	0	0	0	37	0	0	37	0	0	0	0	0	57
% HV	3.4	0	0	0	3.3	0	0	0	0	0	0	1.7	0	0	1.7	0	0	0	0	0	2
B/SB	5	0	0	0	5	0	0	0	0	0	0	11	0	0	11	0	0	0	0	0	16
% B/SB	0.8	0	0	0	0.8	0	0	0	0	0	0	0.5	0	0	0.5	0	0	0	0	0	0.6

Start Time	Ponton Avenue Eastbound					Ponton Avenue Westbound					Blondell Avenue Northbound					Blondell Avenue Southbound					Int. Total
	Left	Thru	Right	Peds	App. Total	Left	Thru	Right	Peds	App. Total	Left	Thru	Right	Peds	App. Total	Left	Thru	Right	Peds	App. Total	
Peak Hour Analysis From 07:45 AM to 08:30 AM - Peak 1 of 1																					
Peak Hour for Entire Intersection Begins at 07:45 AM																					
07:45 AM	8	0	0	2	10	0	0	0	2	2	0	104	0	2	106	0	0	0	0	0	118
08:00 AM	23	0	0	0	23	0	0	0	1	1	0	93	0	1	94	0	0	0	0	0	118
08:15 AM	20	0	0	1	21	0	0	0	0	0	0	109	0	3	112	0	0	0	0	0	133
08:30 AM	18	0	0	0	18	0	0	0	0	0	0	87	0	0	87	0	0	0	0	0	105
Total Volume	69	0	0	3	72	0	0	0	3	3	0	393	0	6	399	0	0	0	0	0	474
% App. Total	95.8	0	0	4.2		0	0	0	100		0	98.5	0	1.5		0	0	0	0		
PHF	.750	.000	.000	.375	.783	.000	.000	.000	.375	.375	.000	.901	.000	.500	.891	.000	.000	.000	.000	.000	.891
Auto	65	0	0	3	68	0	0	0	3	3	0	385	0	6	391	0	0	0	0	0	462
% Auto	94.2	0	0	100	94.4	0	0	0	100	100	0	98.0	0	100	98.0	0	0	0	0	0	97.5
HV	3	0	0	0	3	0	0	0	0	0	0	5	0	0	5	0	0	0	0	0	8
% HV	4.3	0	0	0	4.2	0	0	0	0	0	0	1.3	0	0	1.3	0	0	0	0	0	1.7
B/SB	1	0	0	0	1	0	0	0	0	0	0	3	0	0	3	0	0	0	0	0	4
% B/SB	1.4	0	0	0	1.4	0	0	0	0	0	0	0.8	0	0	0.8	0	0	0	0	0	0.8

Stonefield Engineering & Design, LLC

27-02 41st Avenue, Long Island City, NY 11101
718.606.8305 t.

Intersection of Ponton Avenue (E/W)
and Blondell Avenue (N/S)
Bronx, New York
Wednesday, November 12, 2014

File Name : L-17009 Blondell & Ponton (wkdy)
Site Code : 00017009
Start Date : 11/12/2014
Page No : 3

Start Time	Ponton Avenue Eastbound					Ponton Avenue Westbound					Blondell Avenue Northbound					Blondell Avenue Southbound					Int. Total
	Left	Thru	Right	Peds	App. Total	Left	Thru	Right	Peds	App. Total	Left	Thru	Right	Peds	App. Total	Left	Thru	Right	Peds	App. Total	
Peak Hour Analysis From 12:00 PM to 12:45 PM - Peak 1 of 1																					
Peak Hour for Entire Intersection Begins at 12:00 PM																					
12:00 PM	18	0	0	0	18	0	0	0	0	0	0	63	0	1	64	0	0	0	0	0	82
12:15 PM	28	0	0	0	28	0	0	0	0	0	0	65	0	2	67	0	0	0	0	0	95
12:30 PM	28	0	0	0	28	0	0	0	0	0	0	64	0	2	66	0	0	0	0	0	94
12:45 PM	22	0	0	0	22	0	0	0	1	1	0	65	0	5	70	0	0	0	0	0	93
Total Volume	96	0	0	0	96	0	0	0	1	1	0	257	0	10	267	0	0	0	0	0	364
% App. Total	100	0	0	0		0	0	0	100		0	96.3	0	3.7		0	0	0	0		
PHF	.857	.000	.000	.000	.857	.000	.000	.000	.250	.250	.000	.988	.000	.500	.954	.000	.000	.000	.000	.000	.958
Auto	95	0	0	0	95	0	0	0	1	1	0	251	0	10	261	0	0	0	0	0	357
% Auto	99.0	0	0	0	99.0	0	0	0	100	100	0	97.7	0	100	97.8	0	0	0	0	0	98.1
HV	1	0	0	0	1	0	0	0	0	0	0	4	0	0	4	0	0	0	0	0	5
% HV	1.0	0	0	0	1.0	0	0	0	0	0	0	1.6	0	0	1.5	0	0	0	0	0	1.4
B/SB	0	0	0	0	0	0	0	0	0	0	0	2	0	0	2	0	0	0	0	0	2
% B/SB	0	0	0	0	0	0	0	0	0	0	0	0.8	0	0	0.7	0	0	0	0	0	0.5

Peak Hour Analysis From 04:30 PM to 05:15 PM - Peak 1 of 1
Peak Hour for Entire Intersection Begins at 04:30 PM

04:30 PM	31	0	0	0	31	0	0	0	0	0	0	84	0	0	84	0	0	0	0	0	115
04:45 PM	24	0	0	0	24	0	0	0	0	0	0	63	0	0	63	0	0	0	0	0	87
05:00 PM	12	0	0	0	12	0	0	0	0	0	0	63	0	0	63	0	0	0	0	0	75
05:15 PM	14	0	0	0	14	0	0	0	0	0	0	57	0	0	57	0	0	0	0	0	71
Total Volume	81	0	0	0	81	0	0	0	0	0	0	267	0	0	267	0	0	0	0	0	348
% App. Total	100	0	0	0		0	0	0	0		0	100	0	0		0	0	0	0		
PHF	.653	.000	.000	.000	.653	.000	.000	.000	.000	.000	.000	.795	.000	.000	.795	.000	.000	.000	.000	.000	.757
Auto	81	0	0	0	81	0	0	0	0	0	0	264	0	0	264	0	0	0	0	0	345
% Auto	100	0	0	0	100	0	0	0	0	0	0	98.9	0	0	98.9	0	0	0	0	0	99.1
HV	0	0	0	0	0	0	0	0	0	0	0	3	0	0	3	0	0	0	0	0	3
% HV	0	0	0	0	0	0	0	0	0	0	0	1.1	0	0	1.1	0	0	0	0	0	0.9
B/SB	0	0	0	0	0	0	0	0	0	0	0	0	0	0	0	0	0	0	0	0	0
% B/SB	0	0	0	0	0	0	0	0	0	0	0	0	0	0	0	0	0	0	0	0	0

Stonefield Engineering & Design, LLC

27-02 41st Avenue, Long Island City, NY 11101

718.606.8305 t.

Intersection of St. Raymond Avenue (E/W)
and Blondell Avenue (N/S)
Bronx, New York
Saturday November 8, 2014

File Name : L-17009 Blondell & St. Raymond (sat)
Site Code : 00017009
Start Date : 11/8/2014
Page No : 1

Groups Printed- Auto - HV - B/SB

Start Time	St. Raymond Avenue Eastbound					St. Raymond Avenue Westbound					Blondell Avenue Northbound					Blondell Avenue Southbound					Int. Total
	Left	Thru	Right	Peds	App. Total	Left	Thru	Right	Peds	App. Total	Left	Thru	Right	Peds	App. Total	Left	Thru	Right	Peds	App. Total	
11:00 AM	5	0	0	0	5	0	0	0	0	0	17	57	0	0	74	0	0	0	0	0	79
11:15 AM	9	0	0	0	9	0	0	0	0	0	14	44	0	0	58	0	0	0	0	0	67
11:30 AM	8	0	0	0	8	0	0	0	0	0	15	45	0	0	60	0	0	0	0	0	68
11:45 AM	8	0	0	0	8	0	0	0	0	0	11	64	0	0	75	0	0	0	0	0	83
Total	30	0	0	0	30	0	0	0	0	0	57	210	0	0	267	0	0	0	0	0	297
12:00 PM	5	0	0	0	5	0	0	0	0	0	12	65	0	0	77	0	0	0	0	0	82
12:15 PM	7	0	0	0	7	0	0	0	0	0	13	73	0	0	86	0	0	0	0	0	93
12:30 PM	2	0	0	0	2	0	0	0	0	0	12	55	0	0	67	0	0	0	0	0	69
12:45 PM	8	0	0	0	8	0	0	0	0	0	12	67	0	0	79	0	0	0	0	0	87
Total	22	0	0	0	22	0	0	0	0	0	49	260	0	0	309	0	0	0	0	0	331
01:00 PM	9	0	0	0	9	0	0	0	0	0	9	48	0	0	57	0	0	0	0	0	66
01:15 PM	9	0	0	0	9	0	0	0	0	0	11	43	0	0	54	0	0	0	0	0	63
01:30 PM	6	0	0	0	6	0	0	0	0	0	12	54	0	0	66	0	0	0	0	0	72
01:45 PM	9	0	0	0	9	0	0	0	0	0	10	51	0	0	61	0	0	0	0	0	70
Total	33	0	0	0	33	0	0	0	0	0	42	196	0	0	238	0	0	0	0	0	271
02:00 PM	10	0	0	0	10	0	0	0	0	0	8	61	0	0	69	0	0	0	0	0	79
02:15 PM	7	0	0	0	7	0	0	0	0	0	10	46	0	0	56	0	0	0	0	0	63
02:30 PM	9	0	0	0	9	0	0	0	0	0	13	64	0	0	77	0	0	0	0	0	86
02:45 PM	2	0	0	0	2	0	0	0	0	0	12	46	0	0	58	0	0	0	0	0	60
Total	28	0	0	0	28	0	0	0	0	0	43	217	0	0	260	0	0	0	0	0	288
03:00 PM	3	0	0	0	3	0	0	0	0	0	13	46	0	0	59	0	0	0	0	0	62
03:15 PM	6	0	0	0	6	0	0	0	0	0	10	49	0	0	59	0	0	0	0	0	65
03:30 PM	5	0	0	0	5	0	0	0	0	0	9	49	0	0	58	0	0	0	0	0	63
03:45 PM	4	0	0	0	4	0	0	0	0	0	10	51	0	0	61	0	0	0	0	0	65
Total	18	0	0	0	18	0	0	0	0	0	42	195	0	0	237	0	0	0	0	0	255
04:00 PM	4	0	0	0	4	0	0	0	0	0	9	52	0	0	61	0	0	0	0	0	65
04:15 PM	7	0	0	0	7	0	0	0	0	0	3	46	0	0	49	0	0	0	0	0	56
04:30 PM	9	0	0	0	9	0	0	0	0	0	13	36	0	0	49	0	0	0	0	0	58
04:45 PM	4	0	0	0	4	0	0	0	0	0	3	40	0	0	43	0	0	0	0	0	47
Total	24	0	0	0	24	0	0	0	0	0	28	174	0	0	202	0	0	0	0	0	226
Grand Total	155	0	0	0	155	0	0	0	0	0	261	1252	0	0	1513	0	0	0	0	0	1668
Apprch %	100	0	0	0		0	0	0	0		17.3	82.7	0	0		0	0	0	0		
Total %	9.3	0	0	0	9.3	0	0	0	0	0	15.6	75.1	0	0	90.7	0	0	0	0	0	
Auto	151	0	0	0	151	0	0	0	0	0	255	1226	0	0	1481	0	0	0	0	0	1632
% Auto	97.4	0	0	0	97.4	0	0	0	0	0	97.7	97.9	0	0	97.9	0	0	0	0	0	97.8
HV	4	0	0	0	4	0	0	0	0	0	5	25	0	0	30	0	0	0	0	0	34
% HV	2.6	0	0	0	2.6	0	0	0	0	0	1.9	2	0	0	2	0	0	0	0	0	2
B/SB	0	0	0	0	0	0	0	0	0	0	1	1	0	0	2	0	0	0	0	0	2
% B/SB	0	0	0	0	0	0	0	0	0	0	0.4	0.1	0	0	0.1	0	0	0	0	0	0.1

Stonefield Engineering & Design, LLC

27-02 41st Avenue, Long Island City, NY 11101
718.606.8305 t.

Intersection of St. Raymond Avenue (E/W)
and Blondell Avenue (N/S)
Bronx, New York
Saturday November 8, 2014

File Name : L-17009 Blondell & St. Raymond (sat)
Site Code : 00017009
Start Date : 11/8/2014
Page No : 2

Start Time	St. Raymond Avenue Eastbound					St. Raymond Avenue Westbound					Blondell Avenue Northbound					Blondell Avenue Southbound					Int. Total
	Left	Thru	Right	Peds	App. Total	Left	Thru	Right	Peds	App. Total	Left	Thru	Right	Peds	App. Total	Left	Thru	Right	Peds	App. Total	
Peak Hour Analysis From 12:00 PM to 12:45 PM - Peak 1 of 1																					
Peak Hour for Entire Intersection Begins at 12:00 PM																					
12:00 PM	5	0	0	0	5	0	0	0	0	0	12	65	0	0	77	0	0	0	0	0	82
12:15 PM	7	0	0	0	7	0	0	0	0	0	13	73	0	0	86	0	0	0	0	0	93
12:30 PM	2	0	0	0	2	0	0	0	0	0	12	55	0	0	67	0	0	0	0	0	69
12:45 PM	8	0	0	0	8	0	0	0	0	0	12	67	0	0	79	0	0	0	0	0	87
Total Volume	22	0	0	0	22	0	0	0	0	0	49	260	0	0	309	0	0	0	0	0	331
% App. Total	100	0	0	0	100	0	0	0	0	0	15.9	84.1	0	0	100	0	0	0	0	0	100
PHF	.688	.000	.000	.000	.688	.000	.000	.000	.000	.000	.942	.890	.000	.000	.898	.000	.000	.000	.000	.000	.890
Auto	22	0	0	0	22	0	0	0	0	0	47	258	0	0	305	0	0	0	0	0	327
% Auto	100	0	0	0	100	0	0	0	0	0	95.9	99.2	0	0	98.7	0	0	0	0	0	98.8
HV	0	0	0	0	0	0	0	0	0	0	1	2	0	0	3	0	0	0	0	0	3
% HV	0	0	0	0	0	0	0	0	0	0	2.0	0.8	0	0	1.0	0	0	0	0	0	0.9
B/SB	0	0	0	0	0	0	0	0	0	0	1	0	0	0	1	0	0	0	0	0	1
% B/SB	0	0	0	0	0	0	0	0	0	0	2.0	0	0	0	0.3	0	0	0	0	0	0.3

Stonefield Engineering & Design, LLC

27-02 41st Avenue, Long Island City, NY 11101

718.606.8305 t.

Intersection of St. Raymond Avenue (E/W)
and Blondell Avenue (N/S)
Bronx, New York
Wednesday, November 12, 2014

File Name : L-17009 Blondell & St. Raymond
Site Code : 00017009
Start Date : 11/12/2014
Page No : 1

Groups Printed- Auto - HV - B/SB

Start Time	St. Raymond Avenue Eastbound					St. Raymond Avenue Westbound					Blondell Avenue Northbound					Blondell Avenue Southbound					Int. Total
	Left	Thru	Right	Peds	App. Total	Left	Thru	Right	Peds	App. Total	Left	Thru	Right	Peds	App. Total	Left	Thru	Right	Peds	App. Total	
07:00 AM	4	0	0	0	4	0	0	0	0	0	7	64	0	0	71	0	0	0	0	0	75
07:15 AM	4	0	0	0	4	0	0	0	0	0	5	79	0	1	85	0	0	0	0	0	89
07:30 AM	8	0	0	0	8	0	0	0	0	0	9	79	0	3	91	0	0	0	0	0	99
07:45 AM	10	0	0	0	10	0	0	0	0	0	9	100	0	0	109	0	0	0	0	0	119
Total	26	0	0	0	26	0	0	0	0	0	30	322	0	4	356	0	0	0	0	0	382
08:00 AM	9	0	0	0	9	0	0	0	0	0	9	99	0	6	114	0	0	0	0	0	123
08:15 AM	7	0	0	0	7	0	0	0	0	0	11	114	0	0	125	0	0	0	0	0	132
08:30 AM	11	0	0	0	11	0	0	0	0	0	8	90	0	0	98	0	0	0	0	0	109
08:45 AM	10	0	0	0	10	0	0	0	2	2	15	89	0	0	104	0	0	0	0	0	116
Total	37	0	0	0	37	0	0	0	2	2	43	392	0	6	441	0	0	0	0	0	480
09:00 AM	10	0	0	0	10	0	0	0	0	0	13	71	0	0	84	0	0	0	0	0	94
09:15 AM	5	0	0	0	5	0	0	0	0	0	13	72	0	3	88	0	0	0	0	0	93
09:30 AM	3	0	0	2	5	0	0	0	1	1	10	59	0	0	69	0	0	0	0	0	75
09:45 AM	8	0	0	1	9	0	0	0	0	0	10	59	0	0	69	0	0	0	0	0	78
Total	26	0	0	3	29	0	0	0	1	1	46	261	0	3	310	0	0	0	0	0	340
*** BREAK ***																					
11:00 AM	10	0	0	0	10	0	0	0	2	2	13	64	0	3	80	0	0	0	0	0	92
11:15 AM	6	0	0	0	6	0	0	0	1	1	14	60	0	1	75	0	0	0	0	0	82
11:30 AM	3	0	0	0	3	0	0	0	0	0	13	59	0	2	74	0	0	0	0	0	77
11:45 AM	6	0	0	0	6	0	0	0	0	0	7	60	0	2	69	0	0	0	0	0	75
Total	25	0	0	0	25	0	0	0	3	3	47	243	0	8	298	0	0	0	0	0	326
12:00 PM	9	0	0	0	9	0	0	0	0	0	9	68	0	0	77	0	0	0	0	0	86
12:15 PM	8	0	0	0	8	0	0	0	0	0	10	81	0	4	95	0	0	0	0	0	103
12:30 PM	17	0	0	2	19	0	0	0	2	2	16	73	0	2	91	0	0	0	0	0	112
12:45 PM	8	0	0	0	8	0	0	0	2	2	15	72	0	3	90	0	0	0	0	0	100
Total	42	0	0	2	44	0	0	0	4	4	50	294	0	9	353	0	0	0	0	0	401
01:00 PM	14	0	0	0	14	0	0	0	0	0	10	49	0	2	61	0	0	0	0	0	75
01:15 PM	8	0	0	0	8	0	0	0	1	1	13	66	0	4	83	0	0	0	0	0	92
01:30 PM	7	0	0	0	7	0	0	0	0	0	13	55	0	3	71	0	0	0	0	0	78
01:45 PM	11	0	0	1	12	0	0	0	1	1	8	57	0	4	69	0	0	0	0	0	82
Total	40	0	0	1	41	0	0	0	2	2	44	227	0	13	284	0	0	0	0	0	327
*** BREAK ***																					
04:00 PM	8	0	0	0	8	0	0	0	3	3	11	80	0	6	97	0	0	0	0	0	108
04:15 PM	8	0	0	0	8	0	0	0	0	0	19	76	0	2	97	0	0	0	0	0	105
04:30 PM	6	0	0	0	6	0	0	0	3	3	19	90	0	4	113	0	0	0	0	0	122
04:45 PM	8	0	0	0	8	0	0	0	1	1	18	67	0	0	85	0	0	0	0	0	94
Total	30	0	0	0	30	0	0	0	7	7	67	313	0	12	392	0	0	0	0	0	429

Stonefield Engineering & Design, LLC

27-02 41st Avenue, Long Island City, NY 11101
718.606.8305 t.

Intersection of St. Raymond Avenue (E/W)
and Blondell Avenue (N/S)
Bronx, New York
Wednesday, November 12, 2014

File Name : L-17009 Blondell & St. Raymond
Site Code : 00017009
Start Date : 11/12/2014
Page No : 2

Groups Printed- Auto - HV - B/SB

Start Time	St. Raymond Avenue Eastbound					St. Raymond Avenue Westbound					Blondell Avenue Northbound					Blondell Avenue Southbound					Int. Total
	Left	Thru	Right	Peds	App. Total	Left	Thru	Right	Peds	App. Total	Left	Thru	Right	Peds	App. Total	Left	Thru	Right	Peds	App. Total	
05:00 PM	9	0	0	0	9	0	0	0	1	1	10	59	0	5	74	0	0	0	0	0	84
05:15 PM	10	0	0	0	10	0	0	0	0	0	16	56	0	5	77	0	0	0	0	0	87
05:30 PM	12	0	0	0	12	0	0	0	0	0	11	57	0	8	76	0	0	0	0	0	88
05:45 PM	11	0	0	0	11	0	0	0	0	0	15	37	0	5	57	0	0	0	0	0	68
Total	42	0	0	0	42	0	0	0	1	1	52	209	0	23	284	0	0	0	0	0	327
Grand Total	268	0	0	6	274	0	0	0	20	20	379	2261	0	78	2718	0	0	0	0	0	3012
Apprch %	97.8	0	0	2.2		0	0	0	100		13.9	83.2	0	2.9		0	0	0	0		
Total %	8.9	0	0	0.2	9.1	0	0	0	0.7	0.7	12.6	75.1	0	2.6	90.2	0	0	0	0	0	
Auto	258	0	0	6	264	0	0	0	20	20	364	2195	0	78	2637	0	0	0	0	0	2921
% Auto	96.3	0	0	100	96.4	0	0	0	100	100	96	97.1	0	100	97	0	0	0	0	0	97
HV	9	0	0	0	9	0	0	0	0	0	13	44	0	0	57	0	0	0	0	0	66
% HV	3.4	0	0	0	3.3	0	0	0	0	0	3.4	1.9	0	0	2.1	0	0	0	0	0	2.2
B/SB	1	0	0	0	1	0	0	0	0	0	2	22	0	0	24	0	0	0	0	0	25
% B/SB	0.4	0	0	0	0.4	0	0	0	0	0	0.5	1	0	0	0.9	0	0	0	0	0	0.8

Start Time	St. Raymond Avenue Eastbound					St. Raymond Avenue Westbound					Blondell Avenue Northbound					Blondell Avenue Southbound					Int. Total
	Left	Thru	Right	Peds	App. Total	Left	Thru	Right	Peds	App. Total	Left	Thru	Right	Peds	App. Total	Left	Thru	Right	Peds	App. Total	
Peak Hour Analysis From 07:45 AM to 08:30 AM - Peak 1 of 1																					
Peak Hour for Entire Intersection Begins at 07:45 AM																					
07:45 AM	10	0	0	0	10	0	0	0	0	0	9	100	0	0	109	0	0	0	0	0	119
08:00 AM	9	0	0	0	9	0	0	0	0	0	9	99	0	6	114	0	0	0	0	0	123
08:15 AM	7	0	0	0	7	0	0	0	0	0	11	114	0	0	125	0	0	0	0	0	132
08:30 AM	11	0	0	0	11	0	0	0	0	0	8	90	0	0	98	0	0	0	0	0	109
Total Volume	37	0	0	0	37	0	0	0	0	0	37	403	0	6	446	0	0	0	0	0	483
% App. Total	100	0	0	0		0	0	0	0		8.3	90.4	0	1.3		0	0	0	0		
PHF	.841	.000	.000	.000	.841	.000	.000	.000	.000	.000	.841	.884	.000	.250	.892	.000	.000	.000	.000	.000	.915
Auto	36	0	0	0	36	0	0	0	0	0	36	394	0	6	436	0	0	0	0	0	472
% Auto	97.3	0	0	0	97.3	0	0	0	0	0	97.3	97.8	0	100	97.8	0	0	0	0	0	97.7
HV	1	0	0	0	1	0	0	0	0	0	1	5	0	0	6	0	0	0	0	0	7
% HV	2.7	0	0	0	2.7	0	0	0	0	0	2.7	1.2	0	0	1.3	0	0	0	0	0	1.4
B/SB	0	0	0	0	0	0	0	0	0	0	0	4	0	0	4	0	0	0	0	0	4
% B/SB	0	0	0	0	0	0	0	0	0	0	0	1.0	0	0	0.9	0	0	0	0	0	0.8

Stonefield Engineering & Design, LLC

27-02 41st Avenue, Long Island City, NY 11101

718.606.8305 t.

Intersection of St. Raymond Avenue (E/W)
and Blondell Avenue (N/S)
Bronx, New York
Wednesday, November 12, 2014

File Name : L-17009 Blondell & St. Raymond
Site Code : 00017009
Start Date : 11/12/2014
Page No : 3

Start Time	St. Raymond Avenue Eastbound					St. Raymond Avenue Westbound					Blondell Avenue Northbound					Blondell Avenue Southbound					Int. Total
	Left	Thru	Right	Peds	App. Total	Left	Thru	Right	Peds	App. Total	Left	Thru	Right	Peds	App. Total	Left	Thru	Right	Peds	App. Total	
Peak Hour Analysis From 12:00 PM to 12:45 PM - Peak 1 of 1																					
Peak Hour for Entire Intersection Begins at 12:00 PM																					
12:00 PM	9	0	0	0	9	0	0	0	0	0	9	68	0	0	77	0	0	0	0	0	86
12:15 PM	8	0	0	0	8	0	0	0	0	0	10	81	0	4	95	0	0	0	0	0	103
12:30 PM	17	0	0	2	19	0	0	0	2	2	16	73	0	2	91	0	0	0	0	0	112
12:45 PM	8	0	0	0	8	0	0	0	2	2	15	72	0	3	90	0	0	0	0	0	100
Total Volume	42	0	0	2	44	0	0	0	4	4	50	294	0	9	353	0	0	0	0	0	401
% App. Total	95.5	0	0	4.5		0	0	0	100		14.2	83.3	0	2.5		0	0	0	0	0	
PHF	.618	.000	.000	.250	.579	.000	.000	.000	.500	.500	.781	.907	.000	.563	.929	.000	.000	.000	.000	.000	.895
Auto	40	0	0	2	42	0	0	0	4	4	48	290	0	9	347	0	0	0	0	0	393
% Auto	95.2	0	0	100	95.5	0	0	0	100	100	96.0	98.6	0	100	98.3	0	0	0	0	0	98.0
HV	1	0	0	0	1	0	0	0	0	0	2	3	0	0	5	0	0	0	0	0	6
% HV	2.4	0	0	0	2.3	0	0	0	0	0	4.0	1.0	0	0	1.4	0	0	0	0	0	1.5
B/SB	1	0	0	0	1	0	0	0	0	0	0	1	0	0	1	0	0	0	0	0	2
% B/SB	2.4	0	0	0	2.3	0	0	0	0	0	0	0.3	0	0	0.3	0	0	0	0	0	0.5

Peak Hour Analysis From 04:30 PM to 05:15 PM - Peak 1 of 1

Peak Hour for Entire Intersection Begins at 04:30 PM

04:30 PM	6	0	0	0	6	0	0	0	3	3	19	90	0	4	113	0	0	0	0	0	122
04:45 PM	8	0	0	0	8	0	0	0	1	1	18	67	0	0	85	0	0	0	0	0	94
05:00 PM	9	0	0	0	9	0	0	0	1	1	10	59	0	5	74	0	0	0	0	0	84
05:15 PM	10	0	0	0	10	0	0	0	0	0	16	56	0	5	77	0	0	0	0	0	87
Total Volume	33	0	0	0	33	0	0	0	5	5	63	272	0	14	349	0	0	0	0	0	387
% App. Total	100	0	0	0		0	0	0	100		18.1	77.9	0	4		0	0	0	0	0	
PHF	.825	.000	.000	.000	.825	.000	.000	.000	.417	.417	.829	.756	.000	.700	.772	.000	.000	.000	.000	.000	.793
Auto	32	0	0	0	32	0	0	0	5	5	61	266	0	14	341	0	0	0	0	0	378
% Auto	97.0	0	0	0	97.0	0	0	0	100	100	96.8	97.8	0	100	97.7	0	0	0	0	0	97.7
HV	1	0	0	0	1	0	0	0	0	0	1	5	0	0	6	0	0	0	0	0	7
% HV	3.0	0	0	0	3.0	0	0	0	0	0	1.6	1.8	0	0	1.7	0	0	0	0	0	1.8
B/SB	0	0	0	0	0	0	0	0	0	0	1	1	0	0	2	0	0	0	0	0	2
% B/SB	0	0	0	0	0	0	0	0	0	0	1.6	0.4	0	0	0.6	0	0	0	0	0	0.5

Stonefield Engineering & Design, LLC

27-02 41st Avenue, Long Island City, NY 11101

718.606.8305 t.

Intersection of Westchester Avenue (E/W)
and Blondell Avenue (N/S)
Bronx, New York
Saturday, November 8, 2014

File Name : L-17009 Blondell & Westchester (sat)
Site Code : 00017009
Start Date : 11/8/2014
Page No : 1

Groups Printed- Auto - HV - B/SB

Start Time	Westchester Avenue Eastbound					Westchester Avenue Westbound					Blondell Avenue Northbound					Blondell Avenue Southbound					Int. Total
	Left	Thru	Right	Peds	App. Total	Left	Thru	Right	Peds	App. Total	Left	Thru	Right	Peds	App. Total	Left	Thru	Right	Peds	App. Total	
11:00 AM	8	64	0	0	72	0	78	16	2	96	25	27	26	1	79	0	0	0	5	5	252
11:15 AM	11	63	0	0	74	0	89	10	1	100	31	26	24	3	84	0	0	0	4	4	262
11:30 AM	11	62	0	0	73	0	77	15	0	92	12	23	26	4	65	0	0	0	3	3	233
11:45 AM	11	49	0	3	63	0	66	16	0	82	18	31	23	5	77	0	0	0	2	2	224
Total	41	238	0	3	282	0	310	57	3	370	86	107	99	13	305	0	0	0	14	14	971
12:00 PM	14	62	0	4	80	0	86	18	0	104	23	32	18	3	76	0	0	0	5	5	265
12:15 PM	18	53	0	0	71	0	102	13	4	119	21	28	33	4	86	0	0	0	4	4	280
12:30 PM	13	81	0	2	96	0	82	12	3	97	27	30	33	5	95	0	0	0	3	3	291
12:45 PM	16	66	0	1	83	0	106	15	5	126	22	33	27	2	84	0	0	0	7	7	300
Total	61	262	0	7	330	0	376	58	12	446	93	123	111	14	341	0	0	0	19	19	1136
01:00 PM	14	49	0	0	63	0	95	10	0	105	21	21	29	7	78	0	0	0	8	8	254
01:15 PM	9	50	0	0	59	0	88	17	7	112	23	19	31	6	79	0	0	0	1	1	251
01:30 PM	16	83	0	2	101	0	82	8	6	96	12	26	26	4	68	0	0	0	0	0	265
01:45 PM	13	70	0	3	86	0	72	14	4	90	34	28	33	3	98	0	0	0	4	4	278
Total	52	252	0	5	309	0	337	49	17	403	90	94	119	20	323	0	0	0	13	13	1048
02:00 PM	10	77	0	0	87	0	89	14	0	103	15	34	28	5	82	0	0	0	3	3	275
02:15 PM	12	62	0	4	78	0	83	11	3	97	31	29	24	1	85	0	0	0	5	5	265
02:30 PM	15	63	0	0	78	0	89	14	1	104	17	29	26	6	78	0	0	0	4	4	264
02:45 PM	16	53	0	0	69	0	101	14	1	116	10	31	25	7	73	0	0	0	2	2	260
Total	53	255	0	4	312	0	362	53	5	420	73	123	103	19	318	0	0	0	14	14	1064
03:00 PM	11	64	0	2	77	0	79	18	0	97	20	34	36	3	93	0	0	0	4	4	271
03:15 PM	17	48	0	2	67	0	121	15	4	140	10	23	20	4	57	0	0	0	4	4	268
03:30 PM	6	63	0	0	69	0	66	15	5	86	21	29	16	2	68	0	0	0	2	2	225
03:45 PM	17	61	0	2	80	0	94	9	0	103	18	29	25	5	77	0	0	0	0	0	260
Total	51	236	0	6	293	0	360	57	9	426	69	115	97	14	295	0	0	0	10	10	1024
04:00 PM	20	77	0	1	98	0	64	11	2	77	33	25	50	3	111	0	0	0	0	0	286
04:15 PM	13	50	0	0	63	0	97	12	1	110	18	19	18	4	59	0	0	0	5	5	237
04:30 PM	12	96	0	3	111	0	102	9	0	111	14	19	23	2	58	0	0	0	0	0	280
04:45 PM	12	60	0	0	72	0	57	9	0	66	27	22	24	5	78	0	0	0	2	2	218
Total	57	283	0	4	344	0	320	41	3	364	92	85	115	14	306	0	0	0	7	7	1021
Grand Total	315	1526	0	29	1870	0	2065	315	49	2429	503	647	644	94	1888	0	0	0	77	77	6264
Apprch %	16.8	81.6	0	1.6		0	85	13	2		26.6	34.3	34.1	5		0	0	0	100		
Total %	5	24.4	0	0.5	29.9	0	33	5	0.8	38.8	8	10.3	10.3	1.5	30.1	0	0	0	1.2	1.2	
Auto	302	1449	0	29	1780	0	1954	313	49	2316	495	638	638	94	1865	0	0	0	77	77	6038
% Auto	95.9	95	0	100	95.2	0	94.6	99.4	100	95.3	98.4	98.6	99.1	100	98.8	0	0	0	100	100	96.4
HV	10	18	0	0	28	0	26	1	0	27	5	9	5	0	19	0	0	0	0	0	74
% HV	3.2	1.2	0	0	1.5	0	1.3	0.3	0	1.1	1	1.4	0.8	0	1	0	0	0	0	0	1.2
B/SB	3	59	0	0	62	0	85	1	0	86	3	0	1	0	4	0	0	0	0	0	152
% B/SB	1	3.9	0	0	3.3	0	4.1	0.3	0	3.5	0.6	0	0.2	0	0.2	0	0	0	0	0	2.4

Stonefield Engineering & Design, LLC

27-02 41st Avenue, Long Island City, NY 11101

718.606.8305 t.

Intersection of Westchester Avenue (E/W)
and Blondell Avenue (N/S)
Bronx, New York
Saturday, November 8, 2014

File Name : L-17009 Blondell & Westchester (sat)
Site Code : 00017009
Start Date : 11/8/2014
Page No : 2

Start Time	Westchester Avenue Eastbound					Westchester Avenue Westbound					Blondell Avenue Northbound					Blondell Avenue Southbound					Int. Total
	Left	Thru	Right	Peds	App. Total	Left	Thru	Right	Peds	App. Total	Left	Thru	Right	Peds	App. Total	Left	Thru	Right	Peds	App. Total	
Peak Hour Analysis From 12:00 PM to 12:45 PM - Peak 1 of 1																					
Peak Hour for Entire Intersection Begins at 12:00 PM																					
12:00 PM	14	62	0	4	80	0	86	18	0	104	23	32	18	3	76	0	0	0	5	5	265
12:15 PM	18	53	0	0	71	0	102	13	4	119	21	28	33	4	86	0	0	0	4	4	280
12:30 PM	13	81	0	2	96	0	82	12	3	97	27	30	33	5	95	0	0	0	3	3	291
12:45 PM	16	66	0	1	83	0	106	15	5	126	22	33	27	2	84	0	0	0	7	7	300
Total Volume	61	262	0	7	330	0	376	58	12	446	93	123	111	14	341	0	0	0	19	19	1136
% App. Total	18.5	79.4	0	2.1		0	84.3	13	2.7		27.3	36.1	32.6	4.1		0	0	0	100		
PHF	.847	.809	.000	.438	.859	.000	.887	.806	.600	.885	.861	.932	.841	.700	.897	.000	.000	.000	.679	.679	.947
Auto	59	246	0	7	312	0	360	57	12	429	92	120	109	14	335	0	0	0	19	19	1095
% Auto	96.7	93.9	0	100	94.5	0	95.7	98.3	100	96.2	98.9	97.6	98.2	100	98.2	0	0	0	100	100	96.4
HV	1	4	0	0	5	0	1	0	0	1	1	3	2	0	6	0	0	0	0	0	12
% HV	1.6	1.5	0	0	1.5	0	0.3	0	0	0.2	1.1	2.4	1.8	0	1.8	0	0	0	0	0	1.1
B/SB	1	12	0	0	13	0	15	1	0	16	0	0	0	0	0	0	0	0	0	0	29
% B/SB	1.6	4.6	0	0	3.9	0	4.0	1.7	0	3.6	0	0	0	0	0	0	0	0	0	0	2.6

Stonefield Engineering & Design, LLC

27-02 41st Avenue, Long Island City, NY 11101

718.606.8305 t.

Intersection of Westchester Avenue (E/W)
and Blondell Avenue (N/S)
Bronx, New York
Wednesday, November 12, 2014

File Name : L-17009 Blondell & Westchester (wkdy)
Site Code : 00017009
Start Date : 11/12/2014
Page No : 1

Groups Printed- Auto - HV - B/SB

Start Time	Westchester Avenue Eastbound					Westchester Avenue Westbound					Blondell Avenue Northbound					Blondell Avenue Southbound					Int. Total
	Left	Thru	Right	Peds	App. Total	Left	Thru	Right	Peds	App. Total	Left	Thru	Right	Peds	App. Total	Left	Thru	Right	Peds	App. Total	
07:00 AM	10	51	0	2	63	0	100	17	0	117	32	39	8	5	84	0	0	0	4	4	268
07:15 AM	11	65	0	3	79	0	153	28	2	183	33	46	13	3	95	0	0	0	2	2	359
07:30 AM	18	64	0	4	86	0	130	32	3	165	31	35	12	10	88	0	0	0	4	4	343
07:45 AM	20	75	0	3	98	0	153	28	0	181	42	60	14	2	118	0	0	0	3	3	400
Total	59	255	0	12	326	0	536	105	5	646	138	180	47	20	385	0	0	0	13	13	1370
08:00 AM	20	56	0	1	77	0	106	24	0	130	35	55	10	6	106	0	0	0	2	2	315
08:15 AM	17	88	0	2	107	0	145	25	4	174	29	71	16	8	124	0	0	0	1	1	406
08:30 AM	16	51	0	2	69	0	126	21	2	149	26	47	22	3	98	0	0	0	3	3	319
08:45 AM	16	71	0	4	91	0	106	19	3	128	24	59	12	4	99	0	0	0	4	4	322
Total	69	266	0	9	344	0	483	89	9	581	114	232	60	21	427	0	0	0	10	10	1362
09:00 AM	17	68	0	2	87	0	100	13	1	114	22	45	16	2	85	0	0	0	3	3	289
09:15 AM	14	63	0	5	82	0	116	14	3	133	22	42	9	5	78	0	0	0	5	5	298
09:30 AM	18	47	0	9	74	0	112	10	2	124	19	33	20	6	78	0	0	0	6	6	282
09:45 AM	11	60	0	2	73	0	117	18	2	137	16	32	16	1	65	0	0	0	2	2	277
Total	60	238	0	18	316	0	445	55	8	508	79	152	61	14	306	0	0	0	16	16	1146
*** BREAK ***																					
11:00 AM	18	52	0	1	71	0	96	16	0	112	21	20	12	7	60	0	0	0	4	4	247
11:15 AM	18	56	0	2	76	0	87	12	0	99	9	30	11	4	54	0	0	0	2	2	231
11:30 AM	16	64	0	4	84	0	74	14	5	93	21	27	20	3	71	0	0	0	3	3	251
11:45 AM	17	77	0	6	100	0	106	15	3	124	15	22	12	2	51	0	0	0	4	4	279
Total	69	249	0	13	331	0	363	57	8	428	66	99	55	16	236	0	0	0	13	13	1008
12:00 PM	24	81	0	5	110	0	110	18	4	132	16	24	14	3	57	0	0	0	5	5	304
12:15 PM	20	76	0	1	97	0	94	18	1	113	14	30	12	3	59	0	0	0	3	3	272
12:30 PM	17	82	0	2	101	0	135	21	2	158	22	29	20	5	76	0	0	0	4	4	339
12:45 PM	10	69	0	0	79	0	104	21	6	131	15	38	19	8	80	0	0	0	3	3	293
Total	71	308	0	8	387	0	443	78	13	534	67	121	65	19	272	0	0	0	15	15	1208
01:00 PM	12	69	0	2	83	0	89	12	1	102	20	30	22	0	72	0	0	0	3	3	260
01:15 PM	18	17	0	0	35	0	86	16	4	106	20	31	29	5	85	0	0	0	1	1	227
01:30 PM	23	82	0	5	110	0	89	17	7	113	18	20	15	6	59	0	0	0	3	3	285
01:45 PM	14	74	0	0	88	0	111	21	3	135	17	23	25	4	69	0	0	0	2	2	294
Total	67	242	0	7	316	0	375	66	15	456	75	104	91	15	285	0	0	0	9	9	1066
*** BREAK ***																					
04:00 PM	26	75	0	7	108	0	93	24	4	121	20	20	17	11	68	0	0	0	9	9	306
04:15 PM	14	99	0	2	115	0	104	18	3	125	26	34	26	9	95	0	0	0	5	5	340
04:30 PM	19	88	0	4	111	0	85	22	8	115	18	46	29	6	99	0	0	0	3	3	328
04:45 PM	21	83	0	4	108	0	97	16	1	114	13	30	17	2	62	0	0	0	3	3	287
Total	80	345	0	17	442	0	379	80	16	475	77	130	89	28	324	0	0	0	20	20	1261

Stonefield Engineering & Design, LLC

27-02 41st Avenue, Long Island City, NY 11101

718.606.8305 t.

Intersection of Westchester Avenue (E/W)
and Blondell Avenue (N/S)
Bronx, New York
Wednesday, November 12, 2014

File Name : L-17009 Blondell & Westchester (wkdy)
Site Code : 00017009
Start Date : 11/12/2014
Page No : 2

Groups Printed- Auto - HV - B/SB

Start Time	Westchester Avenue Eastbound					Westchester Avenue Westbound					Blondell Avenue Northbound					Blondell Avenue Southbound					Int. Total
	Left	Thru	Right	Peds	App. Total	Left	Thru	Right	Peds	App. Total	Left	Thru	Right	Peds	App. Total	Left	Thru	Right	Peds	App. Total	
05:00 PM	18	94	0	1	113	0	109	19	0	128	23	30	35	2	90	0	0	0	0	0	331
05:15 PM	17	90	0	3	110	0	105	24	0	129	16	20	28	1	65	0	0	0	2	2	306
05:30 PM	23	87	0	1	111	0	114	14	0	128	26	29	19	2	76	0	0	0	1	1	316
05:45 PM	14	91	0	5	110	0	89	10	10	109	21	24	27	4	76	0	0	0	13	13	308
Total	72	362	0	10	444	0	417	67	10	494	86	103	109	9	307	0	0	0	16	16	1261
Grand Total	547	2265	0	94	2906	0	3441	597	84	4122	702	1121	577	142	2542	0	0	0	112	112	9682
Apprch %	18.8	77.9	0	3.2		0	83.5	14.5	2		27.6	44.1	22.7	5.6		0	0	0	100		
Total %	5.6	23.4	0	1	30	0	35.5	6.2	0.9	42.6	7.3	11.6	6	1.5	26.3	0	0	0	1.2	1.2	
Auto	521	1981	0	94	2596	0	3084	583	84	3751	655	1088	558	142	2443	0	0	0	112	112	8902
% Auto	95.2	87.5	0	100	89.3	0	89.6	97.7	100	91	93.3	97.1	96.7	100	96.1	0	0	0	100	100	91.9
HV	16	186	0	0	202	0	249	8	0	257	26	21	14	0	61	0	0	0	0	0	520
% HV	2.9	8.2	0	0	7	0	7.2	1.3	0	6.2	3.7	1.9	2.4	0	2.4	0	0	0	0	0	5.4
B/SB	10	98	0	0	108	0	108	6	0	114	21	12	5	0	38	0	0	0	0	0	260
% B/SB	1.8	4.3	0	0	3.7	0	3.1	1	0	2.8	3	1.1	0.9	0	1.5	0	0	0	0	0	2.7

Start Time	Westchester Avenue Eastbound					Westchester Avenue Westbound					Blondell Avenue Northbound					Blondell Avenue Southbound					Int. Total
	Left	Thru	Right	Peds	App. Total	Left	Thru	Right	Peds	App. Total	Left	Thru	Right	Peds	App. Total	Left	Thru	Right	Peds	App. Total	
Peak Hour Analysis From 07:45 AM to 08:30 AM - Peak 1 of 1																					
Peak Hour for Entire Intersection Begins at 07:45 AM																					
07:45 AM	20	75	0	3	98	0	153	28	0	181	42	60	14	2	118	0	0	0	3	3	400
08:00 AM	20	56	0	1	77	0	106	24	0	130	35	55	10	6	106	0	0	0	2	2	315
08:15 AM	17	88	0	2	107	0	145	25	4	174	29	71	16	8	124	0	0	0	1	1	406
08:30 AM	16	51	0	2	69	0	126	21	2	149	26	47	22	3	98	0	0	0	3	3	319
Total Volume	73	270	0	8	351	0	530	98	6	634	132	233	62	19	446	0	0	0	9	9	1440
% App. Total	20.8	76.9	0	2.3		0	83.6	15.5	0.9		29.6	52.2	13.9	4.3		0	0	0	100		
PHF	.913	.767	.000	.667	.820	.000	.866	.875	.375	.876	.786	.820	.705	.594	.899	.000	.000	.000	.750	.750	.887
Auto	70	227	0	8	305	0	459	93	6	558	129	227	59	19	434	0	0	0	9	9	1306
% Auto	95.9	84.1	0	100	86.9	0	86.6	94.9	100	88.0	97.7	97.4	95.2	100	97.3	0	0	0	100	100	90.7
HV	3	32	0	0	35	0	52	4	0	56	3	3	3	0	9	0	0	0	0	0	100
% HV	4.1	11.9	0	0	10.0	0	9.8	4.1	0	8.8	2.3	1.3	4.8	0	2.0	0	0	0	0	0	6.9
B/SB	0	11	0	0	11	0	19	1	0	20	0	3	0	0	3	0	0	0	0	0	34
% B/SB	0	4.1	0	0	3.1	0	3.6	1.0	0	3.2	0	1.3	0	0	0.7	0	0	0	0	0	2.4

Stonefield Engineering & Design, LLC

27-02 41st Avenue, Long Island City, NY 11101
718.606.8305 t.

Intersection of Westchester Avenue (E/W)
and Blondell Avenue (N/S)
Bronx, New York
Wednesday, November 12, 2014

File Name : L-17009 Blondell & Westchester (wkdy)
Site Code : 00017009
Start Date : 11/12/2014
Page No : 3

Start Time	Westchester Avenue Eastbound					Westchester Avenue Westbound					Blondell Avenue Northbound					Blondell Avenue Southbound					Int. Total
	Left	Thru	Right	Peds	App. Total	Left	Thru	Right	Peds	App. Total	Left	Thru	Right	Peds	App. Total	Left	Thru	Right	Peds	App. Total	
Peak Hour Analysis From 12:00 PM to 12:45 PM - Peak 1 of 1																					
Peak Hour for Entire Intersection Begins at 12:00 PM																					
12:00 PM	24	81	0	5	110	0	110	18	4	132	16	24	14	3	57	0	0	0	5	5	304
12:15 PM	20	76	0	1	97	0	94	18	1	113	14	30	12	3	59	0	0	0	3	3	272
12:30 PM	17	82	0	2	101	0	135	21	2	158	22	29	20	5	76	0	0	0	4	4	339
12:45 PM	10	69	0	0	79	0	104	21	6	131	15	38	19	8	80	0	0	0	3	3	293
Total Volume	71	308	0	8	387	0	443	78	13	534	67	121	65	19	272	0	0	0	15	15	1208
% App. Total	18.3	79.6	0	2.1		0	83	14.6	2.4		24.6	44.5	23.9	7		0	0	0	100		
PHF	.740	.939	.000	.400	.880	.000	.820	.929	.542	.845	.761	.796	.813	.594	.850	.000	.000	.000	.750	.750	.891
Auto	68	281	0	8	357	0	407	77	13	497	62	119	64	19	264	0	0	0	15	15	1133
% Auto	95.8	91.2	0	100	92.2	0	91.9	98.7	100	93.1	92.5	98.3	98.5	100	97.1	0	0	0	100	100	93.8
HV	2	14	0	0	16	0	20	0	0	20	0	2	1	0	3	0	0	0	0	0	39
% HV	2.8	4.5	0	0	4.1	0	4.5	0	0	3.7	0	1.7	1.5	0	1.1	0	0	0	0	0	3.2
B/SB	1	13	0	0	14	0	16	1	0	17	5	0	0	0	5	0	0	0	0	0	36
% B/SB	1.4	4.2	0	0	3.6	0	3.6	1.3	0	3.2	7.5	0	0	0	1.8	0	0	0	0	0	3.0

Peak Hour Analysis From 04:30 PM to 05:15 PM - Peak 1 of 1
Peak Hour for Entire Intersection Begins at 04:30 PM

04:30 PM	19	88	0	4	111	0	85	22	8	115	18	46	29	6	99	0	0	0	3	3	328
04:45 PM	21	83	0	4	108	0	97	16	1	114	13	30	17	2	62	0	0	0	3	3	287
05:00 PM	18	94	0	1	113	0	109	19	0	128	23	30	35	2	90	0	0	0	0	0	331
05:15 PM	17	90	0	3	110	0	105	24	0	129	16	20	28	1	65	0	0	0	2	2	306
Total Volume	75	355	0	12	442	0	396	81	9	486	70	126	109	11	316	0	0	0	8	8	1252
% App. Total	17	80.3	0	2.7		0	81.5	16.7	1.9		22.2	39.9	34.5	3.5		0	0	0	100		
PHF	.893	.944	.000	.750	.978	.000	.908	.844	.281	.942	.761	.685	.779	.458	.798	.000	.000	.000	.667	.667	.946
Auto	74	320	0	12	406	0	364	80	9	453	55	120	107	11	293	0	0	0	8	8	1160
% Auto	98.7	90.1	0	100	91.9	0	91.9	98.8	100	93.2	78.6	95.2	98.2	100	92.7	0	0	0	100	100	92.7
HV	1	25	0	0	26	0	22	0	0	22	12	4	2	0	18	0	0	0	0	0	66
% HV	1.3	7.0	0	0	5.9	0	5.6	0	0	4.5	17.1	3.2	1.8	0	5.7	0	0	0	0	0	5.3
B/SB	0	10	0	0	10	0	10	1	0	11	3	2	0	0	5	0	0	0	0	0	26
% B/SB	0	2.8	0	0	2.3	0	2.5	1.2	0	2.3	4.3	1.6	0	0	1.6	0	0	0	0	0	2.1

Stonefield Engineering & Design, LLC

27-02 41st Avenue, Long Island City, NY 11101
718.606.8305 t.

Intersection of Westchester Avenue (E/W)
and E. Tremont Avenue (N/S)
Bronx, New York
Saturday, November 8, 2014

File Name : L-17009 Westchester & E. Tremont
Site Code : 00017009
Start Date : 11/8/2014
Page No : 1

Groups Printed- Auto - HV - B/SB

Start Time	Westchester Avenue Eastbound					Westchester Avenue Westbound					E. Tremont Avenue Northbound					E. Tremont Avenue Southbound					Int. Total
	Left	Thru	Right	Peds	App. Total	Left	Thru	Right	Peds	App. Total	Left	Thru	Right	Peds	App. Total	Left	Thru	Right	Peds	App. Total	
11:00 AM	0	70	41	20	131	0	75	28	2	105	0	104	0	2	106	2	103	18	60	183	525
11:15 AM	0	72	37	24	133	0	87	33	5	125	0	111	0	5	116	2	104	14	62	182	556
11:30 AM	0	70	24	30	124	0	55	34	6	95	0	112	0	6	118	3	111	16	64	194	531
11:45 AM	0	60	21	31	112	0	58	34	9	101	0	116	0	9	125	0	131	14	63	208	546
Total	0	272	123	105	500	0	275	129	22	426	0	443	0	22	465	7	449	62	249	767	2158
12:00 PM	0	72	32	28	132	0	67	42	10	119	0	114	0	10	124	4	131	12	64	211	586
12:15 PM	0	66	32	10	108	0	81	42	4	127	0	120	0	4	124	5	123	10	61	199	558
12:30 PM	1	86	31	15	133	0	76	38	6	120	0	126	0	6	132	7	117	11	53	188	573
12:45 PM	0	78	31	29	138	0	73	53	8	134	0	109	0	8	117	4	122	16	70	212	601
Total	1	302	126	82	511	0	297	175	28	500	0	469	0	28	497	20	493	49	248	810	2318
01:00 PM	0	61	43	34	138	0	72	44	5	121	0	113	0	5	118	2	131	18	51	202	579
01:15 PM	0	56	21	25	102	0	69	42	7	118	0	102	0	7	109	3	143	11	64	221	550
01:30 PM	0	94	33	21	148	0	65	29	9	103	0	117	0	9	126	5	132	12	52	201	578
01:45 PM	2	77	31	18	128	0	65	41	4	110	0	110	0	4	114	3	142	11	61	217	569
Total	2	288	128	98	516	0	271	156	25	452	0	442	0	25	467	13	548	52	228	841	2276
02:00 PM	0	83	24	17	124	0	65	38	6	109	0	106	0	6	112	3	127	18	59	207	552
02:15 PM	0	73	27	26	126	0	71	43	9	123	0	100	0	9	109	1	117	16	58	192	550
02:30 PM	0	71	33	34	138	0	69	37	7	113	0	93	0	7	100	7	126	13	64	210	561
02:45 PM	0	66	26	34	126	0	77	34	2	113	0	109	0	2	111	3	111	10	42	166	516
Total	0	293	110	111	514	0	282	152	24	458	0	408	0	24	432	14	481	57	223	775	2179
03:00 PM	0	69	24	20	113	0	73	27	3	103	0	111	0	3	114	6	131	15	38	190	520
03:15 PM	0	64	27	24	115	0	100	31	4	135	0	107	0	4	111	1	127	21	51	200	561
03:30 PM	0	65	20	34	119	0	50	37	5	92	0	94	0	5	99	4	119	16	61	200	510
03:45 PM	0	75	35	20	130	0	79	33	6	118	0	110	0	6	116	3	143	12	34	192	556
Total	0	273	106	98	477	0	302	128	18	448	0	422	0	18	440	14	520	64	184	782	2147
04:00 PM	0	95	30	21	146	0	69	28	8	105	0	125	0	8	133	2	131	15	42	190	574
04:15 PM	0	57	35	26	118	0	86	29	7	122	0	108	0	7	115	6	120	17	48	191	546
04:30 PM	0	106	47	18	171	0	76	40	3	119	0	116	0	3	119	2	136	14	51	203	612
04:45 PM	0	70	31	19	120	0	64	20	8	92	0	99	0	8	107	2	111	11	46	170	489
Total	0	328	143	84	555	0	295	117	26	438	0	448	0	26	474	12	498	57	187	754	2221
Grand Total	3	1756	736	578	3073	0	1722	857	143	2722	0	2632	0	143	2775	80	2989	341	1319	4729	13299
Apprch %	0.1	57.1	24	18.8		0	63.3	31.5	5.3		0	94.8	0	5.2		1.7	63.2	7.2	27.9		
Total %	0	13.2	5.5	4.3	23.1	0	12.9	6.4	1.1	20.5	0	19.8	0	1.1	20.9	0.6	22.5	2.6	9.9	35.6	
Auto	0	1728	721	578	3027	0	1654	808	143	2605	0	2572	0	143	2715	21	2921	197	1319	4458	12805
% Auto	0	98.4	98	100	98.5	0	96.1	94.3	100	95.7	0	97.7	0	100	97.8	26.2	97.7	57.8	100	94.3	96.3
HV	0	28	13	0	41	0	25	5	0	30	0	22	0	0	22	0	39	70	0	109	202
% HV	0	1.6	1.8	0	1.3	0	1.5	0.6	0	1.1	0	0.8	0	0	0.8	0	1.3	20.5	0	2.3	1.5
B/SB	3	0	2	0	5	0	43	44	0	87	0	38	0	0	38	59	29	74	0	162	292
% B/SB	100	0	0.3	0	0.2	0	2.5	5.1	0	3.2	0	1.4	0	0	1.4	73.8	1	21.7	0	3.4	2.2

Stonefield Engineering & Design, LLC

27-02 41st Avenue, Long Island City, NY 11101
718.606.8305 t.

Intersection of Westchester Avenue (E/W)
and E. Tremont Avenue (N/S)
Bronx, New York
Saturday, November 8, 2014

File Name : L-17009 Westchester & E. Tremont
Site Code : 00017009
Start Date : 11/8/2014
Page No : 2

Start Time	Westchester Avenue Eastbound					Westchester Avenue Westbound					E. Tremont Avenue Northbound					E. Tremont Avenue Southbound					Int. Total
	Left	Thru	Right	Peds	App. Total	Left	Thru	Right	Peds	App. Total	Left	Thru	Right	Peds	App. Total	Left	Thru	Right	Peds	App. Total	
Peak Hour Analysis From 11:00 AM to 04:45 PM - Peak 1 of 1																					
Peak Hour for Entire Intersection Begins at 12:00 PM																					
12:00 PM	0	72	32	28	132	0	67	42	10	119	0	114	0	10	124	4	131	12	64	211	586
12:15 PM	0	66	32	10	108	0	81	42	4	127	0	120	0	4	124	5	123	10	61	199	558
12:30 PM	1	86	31	15	133	0	76	38	6	120	0	126	0	6	132	7	117	11	53	188	573
12:45 PM	0	78	31	29	138	0	73	53	8	134	0	109	0	8	117	4	122	16	70	212	601
Total Volume	1	302	126	82	511	0	297	175	28	500	0	469	0	28	497	20	493	49	248	810	2318
% App. Total	0.2	59.1	24.7	16		0	59.4	35	5.6		0	94.4	0	5.6		2.5	60.9	6	30.6		
PHF	.250	.878	.984	.707	.926	.000	.917	.825	.700	.933	.000	.931	.000	.700	.941	.714	.941	.766	.886	.955	.964
Auto	0	297	124	82	503	0	291	166	28	485	0	456	0	28	484	8	480	29	248	765	2237
% Auto	0	98.3	98.4	100	98.4	0	98.0	94.9	100	97.0	0	97.2	0	100	97.4	40.0	97.4	59.2	100	94.4	96.5
HV	0	5	2	0	7	0	1	1	0	2	0	5	0	0	5	0	11	10	0	21	35
% HV	0	1.7	1.6	0	1.4	0	0.3	0.6	0	0.4	0	1.1	0	0	1.0	0	2.2	20.4	0	2.6	1.5
B/SB	1	0	0	0	1	0	5	8	0	13	0	8	0	0	8	12	2	10	0	24	46
% B/SB	100	0	0	0	0.2	0	1.7	4.6	0	2.6	0	1.7	0	0	1.6	60.0	0.4	20.4	0	3.0	2.0

Stonefield Engineering & Design, LLC

27-02 41st Avenue, Long Island City, NY 11101

718.606.8305 t.

Intersection of Westchester Avenue (E/W)
and E. Tremont Avenue (N/S)
Bronx, New York
Wednesday, November 12, 2014

File Name : L-17009 Westchester & E. Tremont (wkdy)
Site Code : 00017009
Start Date : 11/8/2014
Page No : 1

Groups Printed- Auto - HV - B/SB

Start Time	Westchester Avenue Eastbound					Westchester Avenue Westbound					E. Tremont Avenue Northbound					E. Tremont Avenue Southbound					Int. Total
	Left	Thru	Right	Peds	App. Total	Left	Thru	Right	Peds	App. Total	Left	Thru	Right	Peds	App. Total	Left	Thru	Right	Peds	App. Total	
07:00 AM	0	58	19	21	98	0	102	31	5	138	0	131	0	9	140	4	50	7	90	151	527
07:15 AM	0	74	37	32	143	0	139	50	7	196	0	159	0	4	163	3	62	8	95	168	670
07:30 AM	0	76	36	45	157	0	114	45	9	168	0	202	0	10	212	4	132	9	120	265	802
07:45 AM	0	91	46	60	197	0	146	50	10	206	0	193	0	15	208	5	133	14	130	282	893
Total	0	299	138	158	595	0	501	176	31	708	0	685	0	38	723	16	377	38	435	866	2892
08:00 AM	0	74	50	35	159	0	110	29	10	149	0	180	0	2	182	3	155	11	125	294	784
08:15 AM	0	101	31	37	169	0	135	39	5	179	0	174	0	10	184	4	104	8	140	256	788
08:30 AM	0	65	23	20	108	0	123	29	10	162	0	155	0	5	160	3	109	13	125	250	680
08:45 AM	0	85	28	11	124	0	95	34	5	134	0	116	0	10	126	2	119	4	80	205	589
Total	0	325	132	103	560	0	463	131	30	624	0	625	0	27	652	12	487	36	470	1005	2841
09:00 AM	0	83	24	15	122	0	86	37	6	129	0	145	0	5	150	2	117	13	102	234	635
09:15 AM	0	75	29	17	121	0	102	33	2	137	0	95	0	3	98	3	98	15	75	191	547
09:30 AM	0	59	16	20	95	0	105	24	5	134	0	106	0	7	113	4	98	12	85	199	541
09:45 AM	0	70	22	13	105	0	100	32	3	135	0	99	0	10	109	2	122	9	65	198	547
Total	0	287	91	65	443	0	393	126	16	535	0	445	0	25	470	11	435	49	327	822	2270
*** BREAK ***																					
11:00 AM	0	68	29	15	112	0	84	30	6	120	0	102	0	5	107	4	129	9	75	217	556
11:15 AM	0	68	22	13	103	0	66	31	4	101	0	90	0	8	98	4	114	9	55	182	484
11:30 AM	0	76	31	14	121	0	68	29	7	104	0	102	0	10	112	4	113	8	61	186	523
11:45 AM	0	89	30	10	129	0	87	33	8	128	0	77	0	7	84	5	121	12	57	195	536
Total	0	301	112	52	465	0	305	123	25	453	0	371	0	30	401	17	477	38	248	780	2099
12:00 PM	0	102	30	6	138	0	92	34	6	132	0	83	0	3	86	3	117	8	46	174	530
12:15 PM	0	88	34	20	142	0	83	24	6	113	0	88	0	5	93	5	115	13	61	194	542
12:30 PM	0	97	34	31	162	0	118	38	4	160	0	96	0	3	99	2	132	11	42	187	608
12:45 PM	0	77	25	24	126	0	96	25	3	124	0	84	0	4	88	2	123	8	31	164	502
Total	0	364	123	81	568	0	389	121	19	529	0	351	0	15	366	12	487	40	180	719	2182
01:00 PM	0	76	29	21	126	0	86	24	7	117	0	112	0	5	117	7	111	8	41	167	527
01:15 PM	0	93	55	34	182	0	68	37	10	115	0	76	0	8	84	5	133	10	50	198	579
01:30 PM	0	102	26	25	153	0	72	34	9	115	0	94	0	5	99	4	129	10	54	197	564
01:45 PM	0	84	33	31	148	0	93	36	8	137	0	92	0	3	95	3	109	12	43	167	547
Total	0	355	143	111	609	0	319	131	34	484	0	374	0	21	395	19	482	40	188	729	2217
*** BREAK ***																					
04:00 PM	0	96	48	30	174	0	85	30	15	130	0	114	0	5	119	7	142	13	89	251	674
04:15 PM	0	110	52	22	184	0	90	42	19	151	0	126	0	4	130	3	179	10	78	270	735
04:30 PM	0	104	44	20	168	0	65	36	35	136	0	134	0	3	137	4	179	16	91	290	731
04:45 PM	0	101	48	25	174	0	82	30	35	147	0	149	0	10	159	4	144	8	101	257	737
Total	0	411	192	97	700	0	322	138	104	564	0	523	0	22	545	18	644	47	359	1068	2877

Stonefield Engineering & Design, LLC

27-02 41st Avenue, Long Island City, NY 11101
718.606.8305 t.

Intersection of Westchester Avenue (E/W)
and E. Tremont Avenue (N/S)
Bronx, New York
Wednesday, November 12, 2014

File Name : L-17009 Westchester & E. Tremont (wkdy)
Site Code : 00017009
Start Date : 11/8/2014
Page No : 2

Groups Printed- Auto - HV - B/SB

Start Time	Westchester Avenue Eastbound					Westchester Avenue Westbound					E. Tremont Avenue Northbound					E. Tremont Avenue Southbound					Int. Total
	Left	Thru	Right	Peds	App. Total	Left	Thru	Right	Peds	App. Total	Left	Thru	Right	Peds	App. Total	Left	Thru	Right	Peds	App. Total	
05:00 PM	0	112	71	30	213	0	100	30	40	170	0	138	0	25	163	3	176	11	108	298	844
05:15 PM	0	104	69	35	208	0	87	36	25	148	0	141	0	15	156	3	199	10	121	333	845
05:30 PM	0	107	51	11	169	0	98	43	10	151	0	139	0	21	160	4	151	13	110	278	758
05:45 PM	0	102	46	19	167	0	77	31	19	127	0	121	0	20	141	2	129	16	130	277	712
Total	0	425	237	95	757	0	362	140	94	596	0	539	0	81	620	12	655	50	469	1186	3159
Grand Total	0	2767	1168	762	4697	0	3054	1086	353	4493	0	3913	0	259	4172	117	4044	338	2676	7175	20537
Apprch %	0	58.9	24.9	16.2		0	68	24.2	7.9		0	93.8	0	6.2		1.6	56.4	4.7	37.3		
Total %	0	13.5	5.7	3.7	22.9	0	14.9	5.3	1.7	21.9	0	19.1	0	1.3	20.3	0.6	19.7	1.6	13	34.9	
Auto	0	2549	1114	762	4425	0	2796	948	353	4097	0	3718	0	259	3977	41	3829	230	2676	6776	19275
% Auto	0	92.1	95.4	100	94.2	0	91.6	87.3	100	91.2	0	95	0	100	95.3	35	94.7	68	100	94.4	93.9
HV	0	84	29	0	113	0	77	31	0	108	0	98	0	0	98	1	89	1	0	91	410
% HV	0	3	2.5	0	2.4	0	2.5	2.9	0	2.4	0	2.5	0	0	2.3	0.9	2.2	0.3	0	1.3	2
B/SB	0	134	25	0	159	0	181	107	0	288	0	97	0	0	97	75	126	107	0	308	852
% B/SB	0	4.8	2.1	0	3.4	0	5.9	9.9	0	6.4	0	2.5	0	0	2.3	64.1	3.1	31.7	0	4.3	4.1

Start Time	Westchester Avenue Eastbound					Westchester Avenue Westbound					E. Tremont Avenue Northbound					E. Tremont Avenue Southbound					Int. Total
	Left	Thru	Right	Peds	App. Total	Left	Thru	Right	Peds	App. Total	Left	Thru	Right	Peds	App. Total	Left	Thru	Right	Peds	App. Total	
Peak Hour Analysis From 07:45 AM to 08:30 AM - Peak 1 of 1																					
Peak Hour for Entire Intersection Begins at 07:45 AM																					
07:45 AM	0	91	46	60	197	0	146	50	10	206	0	193	0	15	208	5	133	14	130	282	893
08:00 AM	0	74	50	35	159	0	110	29	10	149	0	180	0	2	182	3	155	11	125	294	784
08:15 AM	0	101	31	37	169	0	135	39	5	179	0	174	0	10	184	4	104	8	140	256	788
08:30 AM	0	65	23	20	108	0	123	29	10	162	0	155	0	5	160	3	109	13	125	250	680
Total Volume	0	331	150	152	633	0	514	147	35	696	0	702	0	32	734	15	501	46	520	1082	3145
% App. Total	0	52.3	23.7	24		0	73.9	21.1	5		0	95.6	0	4.4		1.4	46.3	4.3	48.1		
PHF	.000	.819	.750	.633	.803	.000	.880	.735	.875	.845	.000	.909	.000	.533	.882	.750	.808	.821	.929	.920	.880
Auto	0	298	142	152	592	0	458	126	35	619	0	675	0	32	707	0	471	32	520	1023	2941
% Auto	0	90.0	94.7	100	93.5	0	89.1	85.7	100	88.9	0	96.2	0	100	96.3	0	94.0	69.6	100	94.5	93.5
HV	0	13	3	0	16	0	17	3	0	20	0	13	0	0	13	0	10	1	0	11	60
% HV	0	3.9	2.0	0	2.5	0	3.3	2.0	0	2.9	0	1.9	0	0	1.8	0	2.0	2.2	0	1.0	1.9
B/SB	0	20	5	0	25	0	39	18	0	57	0	14	0	0	14	15	20	13	0	48	144
% B/SB	0	6.0	3.3	0	3.9	0	7.6	12.2	0	8.2	0	2.0	0	0	1.9	100	4.0	28.3	0	4.4	4.6

Stonefield Engineering & Design, LLC

27-02 41st Avenue, Long Island City, NY 11101
718.606.8305 t.

Intersection of Westchester Avenue (E/W)
and E. Tremont Avenue (N/S)
Bronx, New York
Wednesday, November 12, 2014

File Name : L-17009 Westchester & E. Tremont (wkdy)
Site Code : 00017009
Start Date : 11/8/2014
Page No : 3

Start Time	Westchester Avenue Eastbound					Westchester Avenue Westbound					E. Tremont Avenue Northbound					E. Tremont Avenue Southbound					Int. Total
	Left	Thru	Right	Peds	App. Total	Left	Thru	Right	Peds	App. Total	Left	Thru	Right	Peds	App. Total	Left	Thru	Right	Peds	App. Total	
Peak Hour Analysis From 12:00 PM to 12:45 PM - Peak 1 of 1																					
Peak Hour for Entire Intersection Begins at 12:00 PM																					
12:00 PM	0	102	30	6	138	0	92	34	6	132	0	83	0	3	86	3	117	8	46	174	530
12:15 PM	0	88	34	20	142	0	83	24	6	113	0	88	0	5	93	5	115	13	61	194	542
12:30 PM	0	97	34	31	162	0	118	38	4	160	0	96	0	3	99	2	132	11	42	187	608
12:45 PM	0	77	25	24	126	0	96	25	3	124	0	84	0	4	88	2	123	8	31	164	502
Total Volume	0	364	123	81	568	0	389	121	19	529	0	351	0	15	366	12	487	40	180	719	2182
% App. Total	0	64.1	21.7	14.3		0	73.5	22.9	3.6		0	95.9	0	4.1		1.7	67.7	5.6	25		
PHF	.000	.892	.904	.653	.877	.000	.824	.796	.792	.827	.000	.914	.000	.750	.924	.600	.922	.769	.738	.927	.897
Auto	0	345	116	81	542	0	366	107	19	492	0	327	0	15	342	9	455	29	180	673	2049
% Auto	0	94.8	94.3	100	95.4	0	94.1	88.4	100	93.0	0	93.2	0	100	93.4	75.0	93.4	72.5	100	93.6	93.9
HV	0	9	6	0	15	0	12	5	0	17	0	14	0	0	14	0	15	0	0	15	61
% HV	0	2.5	4.9	0	2.6	0	3.1	4.1	0	3.2	0	4.0	0	0	3.8	0	3.1	0	0	2.1	2.8
B/SB	0	10	1	0	11	0	11	9	0	20	0	10	0	0	10	3	17	11	0	31	72
% B/SB	0	2.7	0.8	0	1.9	0	2.8	7.4	0	3.8	0	2.8	0	0	2.7	25.0	3.5	27.5	0	4.3	3.3

Peak Hour Analysis From 04:30 PM to 05:15 PM - Peak 1 of 1

Peak Hour for Entire Intersection Begins at 04:30 PM

04:30 PM	0	104	44	20	168	0	65	36	35	136	0	134	0	3	137	4	179	16	91	290	731
04:45 PM	0	101	48	25	174	0	82	30	35	147	0	149	0	10	159	4	144	8	101	257	737
05:00 PM	0	112	71	30	213	0	100	30	40	170	0	138	0	25	163	3	176	11	108	298	844
05:15 PM	0	104	69	35	208	0	87	36	25	148	0	141	0	15	156	3	199	10	121	333	845
Total Volume	0	421	232	110	763	0	334	132	135	601	0	562	0	53	615	14	698	45	421	1178	3157
% App. Total	0	55.2	30.4	14.4		0	55.6	22	22.5		0	91.4	0	8.6		1.2	59.3	3.8	35.7		
PHF	.000	.940	.817	.786	.896	.000	.835	.917	.844	.884	.000	.943	.000	.530	.943	.875	.877	.703	.870	.884	.934
Auto	0	401	228	110	739	0	307	114	135	556	0	544	0	53	597	0	675	32	421	1128	3020
% Auto	0	95.2	98.3	100	96.9	0	91.9	86.4	100	92.5	0	96.8	0	100	97.1	0	96.7	71.1	100	95.8	95.7
HV	0	3	2	0	5	0	4	4	0	8	0	4	0	0	4	0	7	0	0	7	24
% HV	0	0.7	0.9	0	0.7	0	1.2	3.0	0	1.3	0	0.7	0	0	0.7	0	1.0	0	0	0.6	0.8
B/SB	0	17	2	0	19	0	23	14	0	37	0	14	0	0	14	14	16	13	0	43	113
% B/SB	0	4.0	0.9	0	2.5	0	6.9	10.6	0	6.2	0	2.5	0	0	2.3	100	2.3	28.9	0	3.7	3.6



STONEFIELD ENGINEERING AND DESIGN, LLC

27-02 41st Avenue, Long Island City, NY 11101 - Phone: (718) 606-8305

Project: Blondell Avenue Rezoning

Location: Blondell Avenue And East Tremont Avenue

Dates:

10/10/2018

SE&D Job No.: L-17009

Municipality: Bronx, NY

Surveyor's Name: AB

	TIME	DIRECTION	2018 EXISTING TRAFFIC VOLUMES BLONDELL AVENUE AND EAST TREMONT AVENUE
Weekday PM 10/10/2018	4:30	SB L	23
		NB R	63
	4:45	SB L	57
		NB R	118
	5:00	SB L	76
		NB R	166
	5:15	SB L	109
		NB R	234

**MANUAL TURNING MOVEMENT COUNT DATA
PEDESTRIAN**



STONEFIELD ENGINEERING AND DESIGN, LLC

27-02 41st Avenue, Long Island City, NY 11101 - Phone: (718) 606-8305

Project: Blondell Avenue Rezoning

Location: Blondell Avenue

Dates:

9/15/18, 9/20/18, 9/22/18, 9/25/18, 10/9/18

SE&D Job No.: L-17009

Municipality: Bronx, NY

Surveyor's Name: AB

	DATE	DIRECTION	2018 EXISTING VOLUMES EAST TREMONT AVENUE AND WESTCHESTER AVENUE SIDEWALK
Weekday AM	10/9/2018	EB	864
		WB	504
Weekday MID	9/20/2018	EB	295
		WB	236
	9/25/2018	EB	194
		WB	218
	Average	EB	245
		WB	227
Weekday PM	9/20/2018	EB	322
		WB	458
	9/25/2018	EB	285
		WB	277
	Average	EB	304
		WB	368
Saturday	9/15/2018	EB	264
		WB	175
	9/22/2018	EB	126
		WB	169
	Average	EB	195
		WB	172



STONEFIELD ENGINEERING AND DESIGN, LLC

27-02 41st Avenue, Long Island City, NY 11101 - Phone: (718) 606-8305

Project: Blondell Avenue Rezoning

Location: Blondell Avenue

Dates: 9/15/18, 9/20/18, 9/22/18, 9/25/18, 10/9/18

SE&D Job No.: L-17009

Municipality: Bronx, NY

Surveyor's Name: AB

	DATE	DIRECTION	2018 EXISTING VOLUMES BLONDELL AVENUE AND WESTCHESTER AVENUE NORTHERN CROSSWALK
Weekday AM	10/9/2018*	EB	65
		WB	38
Weekday MID	9/20/2018	EB	33
		WB	36
	9/25/2018	EB	19
		WB	29
	Average	EB	26
		WB	33
Weekday PM	9/20/2018	EB	25
		WB	39
	9/25/2018	EB	20
		WB	17
	Average	EB	23
		WB	28
Saturday	9/15/2018	EB	16
		WB	16
	9/22/2018	EB	16
		WB	13
	Average	EB	16
		WB	15

*Based on interpolation of spot count at East Tremont Avenue and Westchester Avenue Sidewalk



STONEFIELD ENGINEERING AND DESIGN, LLC

27-02 41st Avenue, Long Island City, NY 11101 - Phone: (718) 606-8305

Project: Blondell Avenue Rezoning

Location: Blondell Avenue

Dates: 9/15/18, 9/20/18, 9/22/18, 9/25/18, 10/9/18

SE&D Job No.: L-17009

Municipality: Bronx, NY

Surveyor's Name: AB

	DATE	DIRECTION	2018 EXISTING VOLUMES BLONDELL AVENUE AND WESTCHESTER AVENUE EASTERN CROSSWALK
Weekday AM	10/9/2018*	NB	14
		SB	4
Weekday MID	9/20/2018	NB	2
		SB	3
	9/25/2018	NB	2
		SB	4
	Average	NB	2
		SB	4
Weekday PM	9/20/2018	NB	7
		SB	3
	9/25/2018	NB	2
		SB	2
	Average	NB	5
		SB	3
Saturday	9/15/2018	NB	2
		SB	2
	9/22/2018	NB	4
		SB	1
	Average	NB	3
		SB	2

*Based on interpolation of spot count at East Tremont Avenue and Westchester Avenue Sidewalk



STONEFIELD ENGINEERING AND DESIGN, LLC

27-02 41st Avenue, Long Island City, NY 11101 - Phone: (718) 606-8305

Project: Blondell Avenue Rezoning

Location: Blondell Avenue

Dates: 9/15/18, 9/20/18, 9/22/18, 9/25/18, 10/9/18

SE&D Job No.: L-17009

Municipality: Bronx, NY

Surveyor's Name: AB

	DATE	DIRECTION	2018 EXISTING VOLUMES BLONDELL AVENUE AND WESTCHESTER AVENUE NORTHEAST CORNER
Weekday AM	10/9/2018*	South to East	11
		West to North	3
Weekday MID	9/20/2018	South to East	3
		West to North	4
	9/25/2018	South to East	3
		West to North	3
	Average	South to East	3
		West to North	4
Weekday PM	9/20/2018	South to East	2
		West to North	2
	9/25/2018	South to East	5
		West to North	1
	Average	South to East	4
		West to North	2
Saturday	9/15/2018	South to East	4
		West to North	0
	9/22/2018	South to East	3
		West to North	1
	Average	South to East	4
		West to North	1

*Based on interpolation of spot count at East Tremont Avenue and Westchester Avenue Sidewalk



STONEFIELD ENGINEERING AND DESIGN, LLC

27-02 41st Avenue, Long Island City, NY 11101 - Phone: (718) 606-8305

Project: Blondell Avenue Rezoning

Location: Blondell Avenue

Dates: 9/15/18, 9/20/18, 9/22/18, 9/25/18, 10/9/18

SE&D Job No.: L-17009

Municipality: Bronx, NY

Surveyor's Name: AB

	DATE	DIRECTION	2018 EXISTING VOLUMES WESTCHESTER AVENUE SIDEWALK EAST OF BLONDELL AVENUE
Weekday AM	10/9/2018*	EB	71
		WB	33
Weekday MID	9/20/2018	EB	37
		WB	39
	9/25/2018	EB	16
		WB	25
	Average	EB	27
		WB	32
Weekday PM	9/20/2018	EB	30
		WB	34
	9/25/2018	EB	19
		WB	13
	Average	EB	25
		WB	24
Saturday	9/15/2018	EB	20
		WB	19
	9/22/2018	EB	14
		WB	14
	Average	EB	17
		WB	17

*Based on interpolation of spot count at East Tremont Avenue and Westchester Avenue Sidewalk



STONEFIELD ENGINEERING AND DESIGN, LLC

27-02 41st Avenue, Long Island City, NY 11101 - Phone: (718) 606-8305

Project: Blondell Avenue Rezoning

Location: Blondell Avenue

Dates: 9/15/18, 9/20/18, 9/22/18, 9/25/18, 10/9/18

SE&D Job No.: L-17009

Municipality: Bronx, NY

Surveyor's Name: AB

	DATE	DIRECTION	2018 EXISTING VOLUMES BLONDELL AVENUE SIDEWALK NORTH OF WESTCHESTER AVENUE
Weekday AM	10/9/2018*	NB	6
		SB	7
Weekday MID	9/20/2018	NB	3
		SB	6
	9/25/2018	NB	1
		SB	4
	Average	NB	2
		SB	5
Weekday PM	9/20/2018	NB	2
		SB	4
	9/25/2018	NB	1
		SB	5
	Average	NB	2
		SB	5
Saturday	9/15/2018	NB	2
		SB	4
	9/22/2018	NB	1
		SB	1
	Average	NB	2
		SB	3

*Based on interpolation of spot count at East Tremont Avenue and Westchester Avenue Sidewalk



STONEFIELD ENGINEERING AND DESIGN, LLC

27-02 41st Avenue, Long Island City, NY 11101 - Phone: (718) 606-8305

Project: Blondell Avenue Rezoning

Location: Blondell Avenue

Dates: 9/15/18, 9/20/18, 9/22/18, 9/25/18, 10/9/18

SE&D Job No.: L-17009

Municipality: Bronx, NY

Surveyor's Name: AB

	DATE	DIRECTION	2018 EXISTING VOLUMES BLONDELL AVENUE AND FINK AVENUE NORTHERN CROSSWALK
Weekday AM	10/9/2018*	EB	9
		WB	4
Weekday MID	9/20/2018	EB	3
		WB	2
	9/25/2018	EB	1
		WB	2
	Average	EB	2
		WB	2
Weekday PM	9/20/2018	EB	0
		WB	3
	9/25/2018	EB	5
		WB	2
	Average	EB	3
		WB	3
Saturday	9/15/2018	EB	3
		WB	3
	9/22/2018	EB	10
		WB	5
	Average	EB	7
		WB	4

*Based on interpolation of spot count at East Tremont Avenue and Westchester Avenue Sidewalk



STONEFIELD ENGINEERING AND DESIGN, LLC

27-02 41st Avenue, Long Island City, NY 11101 - Phone: (718) 606-8305

Project: Blondell Avenue Rezoning

Location: Blondell Avenue

Dates: 9/15/18, 9/20/18, 9/22/18, 9/25/18, 10/9/18

SE&D Job No.: L-17009

Municipality: Bronx, NY

Surveyor's Name: AB

	DATE	DIRECTION	2018 EXISTING VOLUMES BLONDELL AVENUE AND FINK AVENUE EASTERN CROSSWALK
Weekday AM	10/9/2018*	NB	9
		SB	11
Weekday MID	9/20/2018	NB	6
		SB	6
	9/25/2018	NB	4
		SB	3
	Average	NB	5
		SB	5
Weekday PM	9/20/2018	NB	5
		SB	11
	9/25/2018	NB	0
		SB	5
	Average	NB	3
		SB	8
Saturday	9/15/2018	NB	2
		SB	4
	9/22/2018	NB	2
		SB	6
	Average	NB	2
		SB	5

*Based on interpolation of spot count at East Tremont Avenue and Westchester Avenue Sidewalk



STONEFIELD ENGINEERING AND DESIGN, LLC

27-02 41st Avenue, Long Island City, NY 11101 - Phone: (718) 606-8305

Project: Blondell Avenue Rezoning

Location: Blondell Avenue

Dates: 9/15/18, 9/20/18, 9/22/18, 9/25/18, 10/9/18

SE&D Job No.: L-17009

Municipality: Bronx, NY

Surveyor's Name: AB

	DATE	DIRECTION	2018 EXISTING VOLUMES BLONDELL AVENUE SIDEWALK NORTH OF FINK AVENUE
Weekday AM	10/9/2018*	NB	9
		SB	10
Weekday MID	9/20/2018	NB	5
		SB	3
	9/25/2018	NB	0
		SB	1
	Average	NB	3
		SB	2
Weekday PM	9/20/2018	NB	4
		SB	9
	9/25/2018	NB	2
		SB	5
	Average	NB	3
		SB	7
Saturday	9/15/2018	NB	2
		SB	1
	9/22/2018	NB	6
		SB	3
	Average	NB	4
		SB	2

*Based on interpolation of spot count at East Tremont Avenue and Westchester Avenue Sidewalk

CONDITION DIAGRAM

CONDITION DIAGRAM

Ref# _____ Date: 9/25/2018 Day: Tuesday Inspector: Timothy Chung

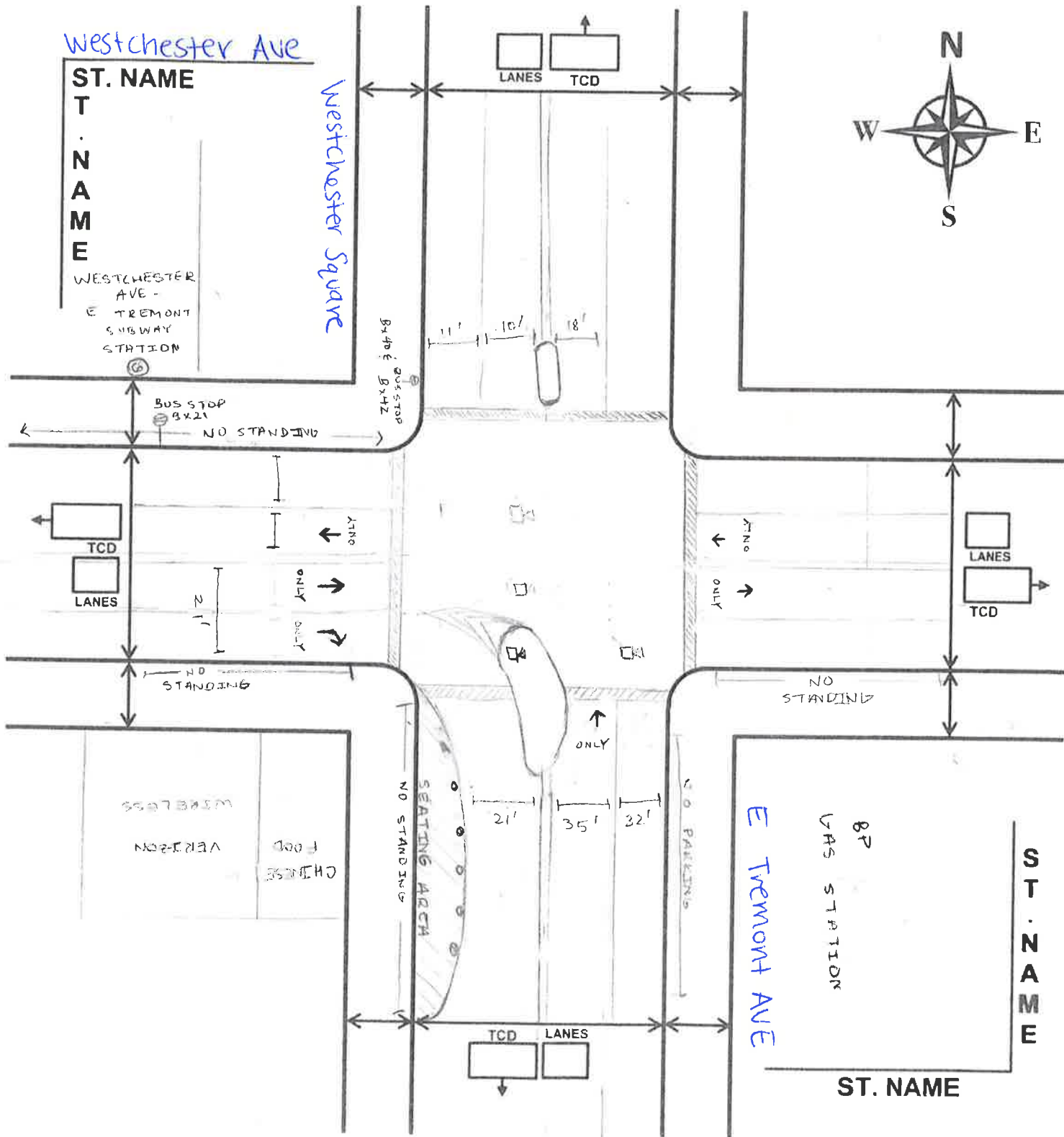

TCD = DISTANCE TO NEAREST TRAFFIC CONTROL DEVICE (Feet)
LANES = NUMBER OF MOVING LANES

NOTE: Indicate all curb regulations, street furniture, curb cuts, and all pavement markings related to the intersection. The # of lanes observed are the traveled lanes for each approach; parking lanes are not included. Show street direction by placing an arrow(s), indicating direction on all legs of the intersection.



STONEFIELD

engineering & design

75 Orient Way • Suite 303

Rutherford, NJ 07070

t. 201.340.4468 • f. 201.340.4472

Tom Straulina

Intersection '1'

Blondell Ave & Westchester Ave

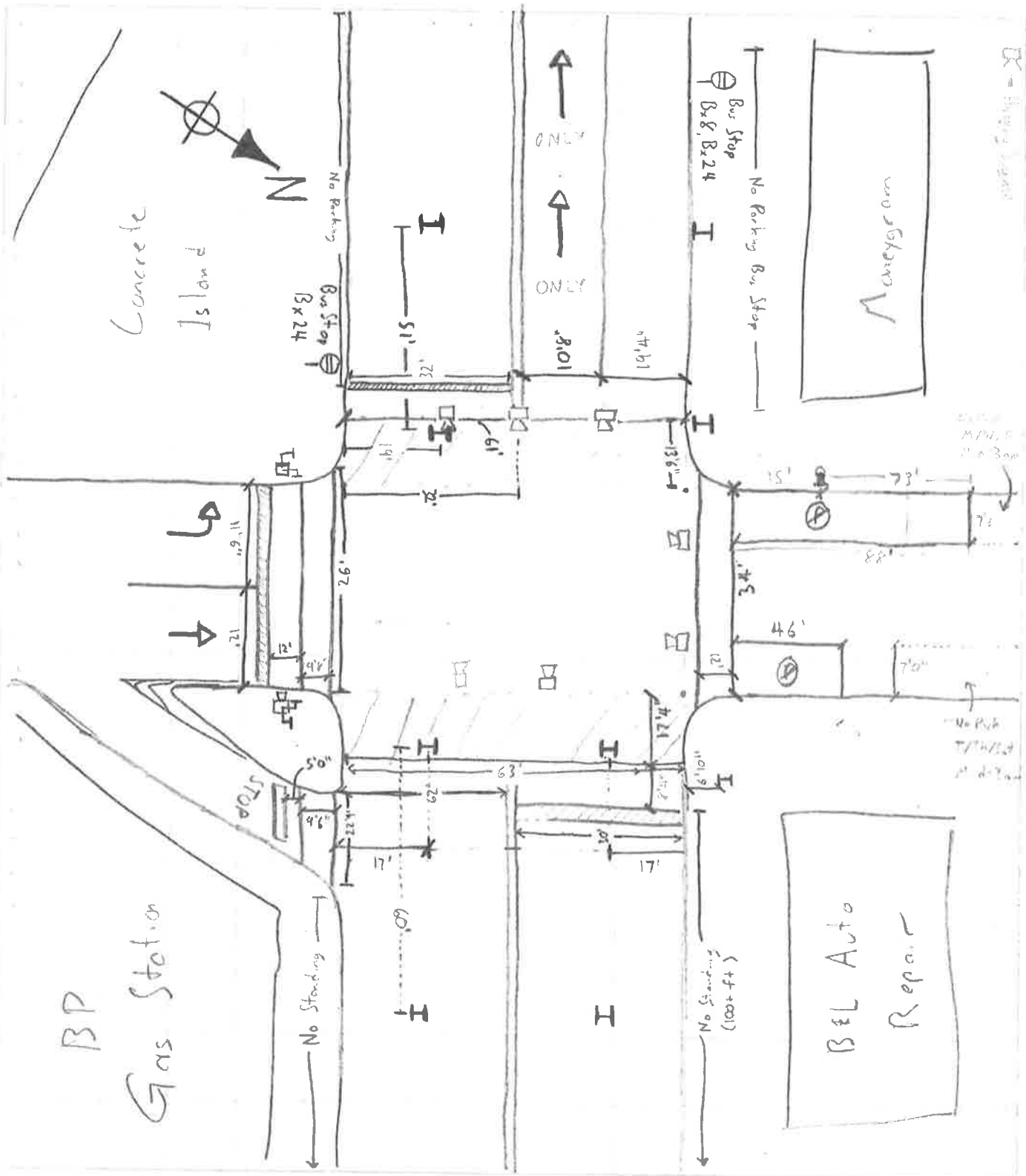

CONDITION DIAGRAM

Ref# _____ Date: 9/25/2018 Day: Tuesday Inspector: Timothy Chung

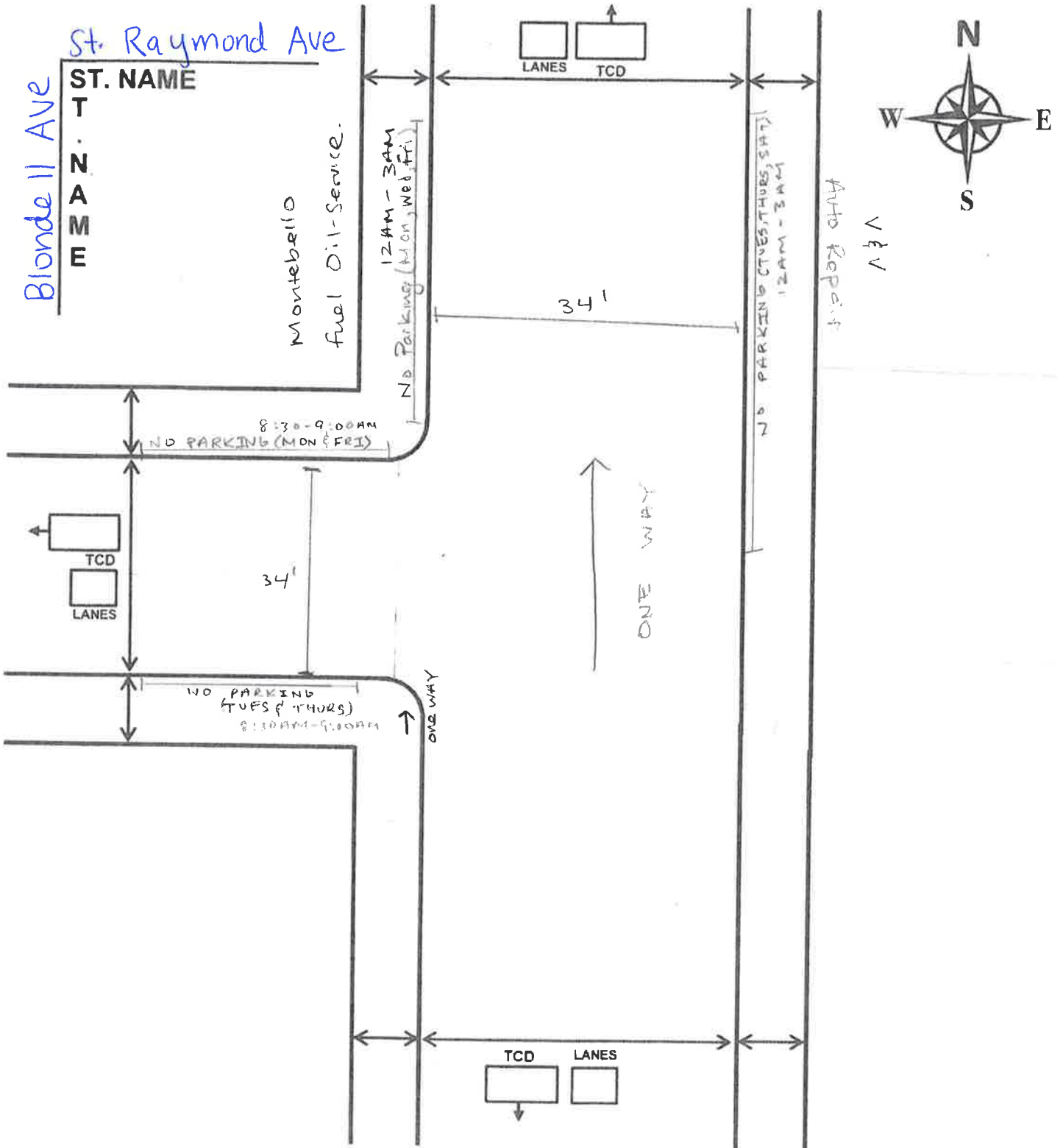

TCD = DISTANCE TO NEAREST TRAFFIC CONTROL DEVICE (Feet)
 LANES = NUMBER OF MOVING LANES

NOTE: Indicate all curb regulations, street furniture, curb cuts, and all pavement markings related to the intersection. The # of lanes observed are the traveled lanes for each approach; parking lanes are not included. Show street direction by placing an arrow(s), indicating direction on all legs of the intersection.

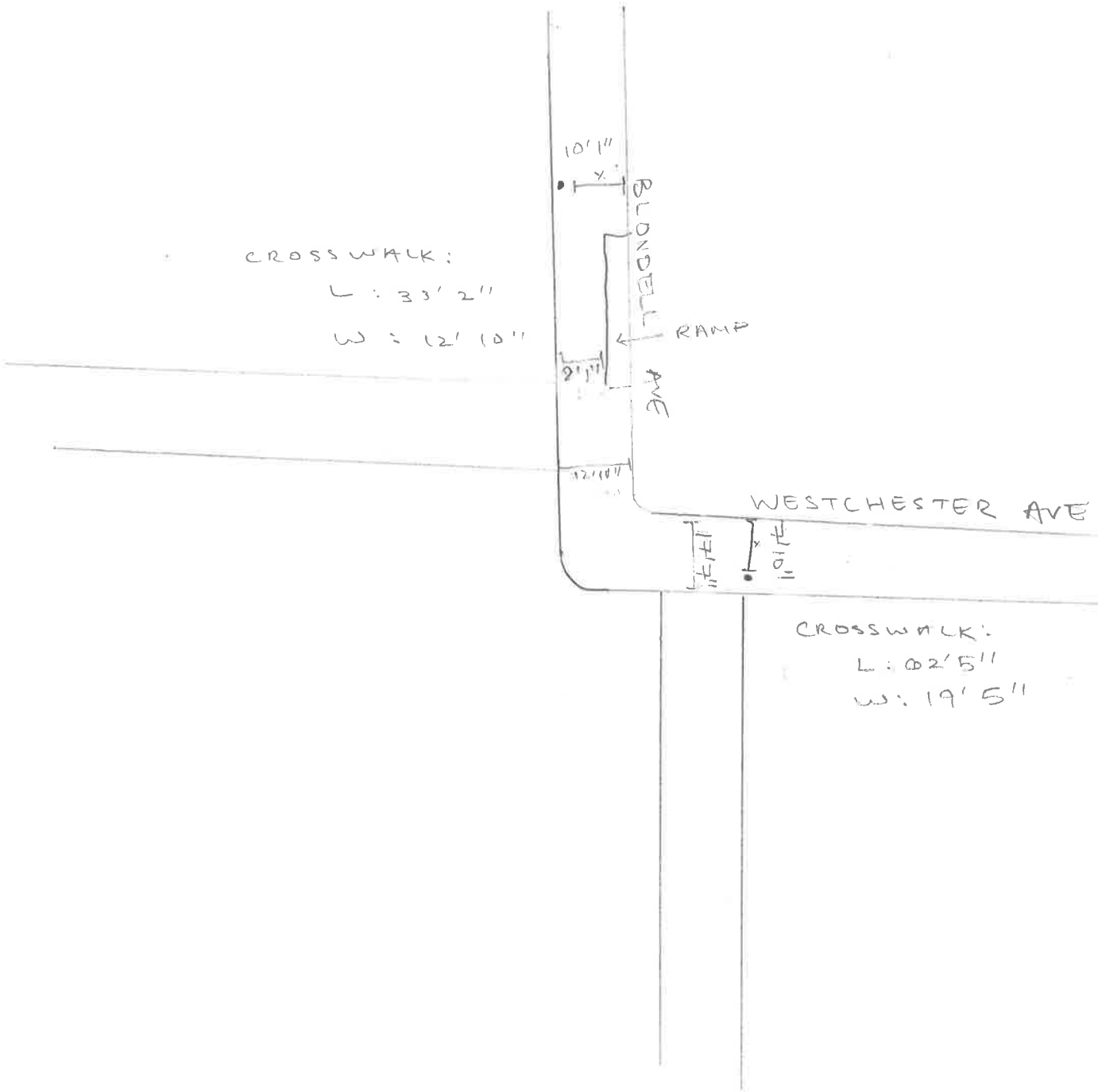

BLONDEL AVE

8' 1"

CROSSWALK:
L: 34' 6" W: 7' 9"

12' 10"

FINK AVE

CROSSWALK:

L: 21' 8"

W: 9' 3"

**NYCDOT TRAFFIC SIGNAL TIMING
& PHASING DIRECTIVE**

1 2 3 4 5 6 7 8 9

1	2	3	4	5
R	R	R	DW	DW
A	A	A	WK	WK
G	G	G		

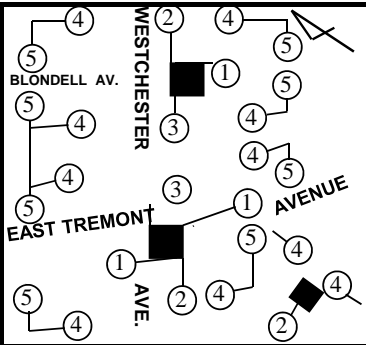

	MON-FRI 06:00-07:00	MON-FRI 07:00-10:30	MON-FRI 10:30-14:36 20:00-23:00	MON-FRI 14:36-15:15	MON-FRI 15:15-19:00	MON-FRI 19:00-20:00	MON-FRI 23:00-06:00	WEEKEND 07:00-01:00	WEEKEND 01:00-07:00
LS #	1	2	3	5	6				
NEMA	1	2	2	1P	2P				
	120 SEC	120 SEC	120 SEC	120 SEC	120 SEC	120 SEC	90 SEC	90 SEC	90 SEC
PHASE A	28	28	28	28	28	28	13	13	13
SPARE	2	2	2	2	2	2	2	2	2
PED CL	21	21	21	21	21	21	21	21	21
VEH CL	3	3	3	3	3	3	3	3	3
VEH CL	2	2	2	2	2	2	2	2	2
	56	56	56	56	56	56	41	41	41
PHASE B	35	35	35	35	35	35	20	20	20
SPARE	2	2	2	2	2	2	2	2	2
PED CL	17	17	17	17	17	17	17	17	17
VEH CL	3	3	3	3	3	3	3	3	3
VEH CL	2	2	2	2	2	2	2	2	2
VEH CL	3	3	3	3	3	3	3	3	3
VEH CL	2	2	2	2	2	2	2	2	2
	64	64	64	64	64	64	49	49	49

CITY OF NEW YORK
BUREAU OF TRAFFIC OPERATIONS
 34-02 Queens Blvd. Long Island City, NY 11101

OFFSET									
65	112	112	112	16	94	88	35	88	

NOTES: NON- ACTUATED
 PC = 3 FT/SEC
 CABINET TYPE: ASTC-6.
 CABINET ADDRESS: 4361
 INTERVAL PROGRAM
 PEDESTRIAN COUNTDOWN

E TREMONT AVE @ WESTCHESTER AVE & BLONDELL AVE.

Prep R.WASEF Date 03/07/16
 Appr. _____ Date _____















03/16	RW	MODIFY TIMING
DATE	BY	REVISIONS

HIGHWAY CAPACITY ANALYSIS DETAIL SHEETS

HCM Unsignalized Intersection Capacity Analysis

3: Blondell Avenue & Ponton Avenue

2018 Existing
AM Peak Hour

												
Movement	EBL	EBT	EBR	WBL	WBT	WBR	NBL	NBT	NBR	SBL	SBT	SBR
Lane Configurations												
Traffic Volume (veh/h)	70	0	0	0	0	0	0	397	0	0	0	0
Future Volume (Veh/h)	70	0	0	0	0	0	0	397	0	0	0	0
Sign Control		Stop			Stop			Free			Free	
Grade		0%			0%			0%			0%	
Peak Hour Factor	0.89	0.89	0.89	0.92	0.92	0.92	0.92	0.92	0.92	0.92	0.92	0.92
Hourly flow rate (vph)	79	0	0	0	0	0	0	432	0	0	0	0
Pedestrians												
Lane Width (ft)												
Walking Speed (ft/s)												
Percent Blockage												
Right turn flare (veh)												
Median type								None			None	
Median storage (veh)												
Upstream signal (ft)												
pX, platoon unblocked												
vC, conflicting volume	432	432	0	432	432	432	0			432		
vC1, stage 1 conf vol												
vC2, stage 2 conf vol												
vCu, unblocked vol	432	432	0	432	432	432	0			432		
tC, single (s)	7.2	6.5	6.2	7.1	6.5	6.2	4.1			4.1		
tC, 2 stage (s)												
tF (s)	3.6	4.0	3.3	3.5	4.0	3.3	2.2			2.2		
p0 queue free %	85	100	100	100	100	100	100			100		
cM capacity (veh/h)	527	516	1085	534	516	624	1623			1128		
Direction, Lane #	EB 1	NB 1										
Volume Total	79	432										
Volume Left	79	0										
Volume Right	0	0										
cSH	527	1700										
Volume to Capacity	0.15	0.25										
Queue Length 95th (ft)	13	0										
Control Delay (s)	13.0	0.0										
Lane LOS	B											
Approach Delay (s)	13.0	0.0										
Approach LOS	B											
Intersection Summary												
Average Delay			2.0									
Intersection Capacity Utilization			31.4%		ICU Level of Service					A		
Analysis Period (min)			15									

HCM Unsignalized Intersection Capacity Analysis

4: Blondell Avenue & St Raymond Avenue

2018 Existing
AM Peak Hour

















Movement	EBL	EBR	NBL	NBT	SBT	SBR
Lane Configurations	↶			↷		
Traffic Volume (veh/h)	37	0	37	407	0	0
Future Volume (Veh/h)	37	0	37	407	0	0
Sign Control	Stop			Free	Free	
Grade	0%			0%	0%	
Peak Hour Factor	0.92	0.92	0.92	0.92	0.92	0.92
Hourly flow rate (vph)	40	0	40	442	0	0
Pedestrians						
Lane Width (ft)						
Walking Speed (ft/s)						
Percent Blockage						
Right turn flare (veh)						
Median type				None	None	
Median storage (veh)						
Upstream signal (ft)						
pX, platoon unblocked						
vC, conflicting volume	522	0	0			
vC1, stage 1 conf vol						
vC2, stage 2 conf vol						
vCu, unblocked vol	522	0	0			
tC, single (s)	6.4	6.2	4.1			
tC, 2 stage (s)						
tF (s)	3.5	3.3	2.2			
p0 queue free %	92	100	98			
cM capacity (veh/h)	501	1085	1617			
Direction, Lane #	EB 1	NB 1				
Volume Total	40	482				
Volume Left	40	40				
Volume Right	0	0				
cSH	501	1617				
Volume to Capacity	0.08	0.02				
Queue Length 95th (ft)	6	2				
Control Delay (s)	12.8	0.8				
Lane LOS	B	A				
Approach Delay (s)	12.8	0.8				
Approach LOS	B					
Intersection Summary						
Average Delay			1.7			
Intersection Capacity Utilization			33.5%	ICU Level of Service	A	
Analysis Period (min)			15			

HCM Unsignalized Intersection Capacity Analysis

3: Ponton Avenue & Blondell Avenue



















2018 Existing
PM Peak Hour

												
Movement	EBL	EBT	EBR	WBL	WBT	WBR	NBL	NBT	NBR	SBL	SBT	SBR
Lane Configurations												
Traffic Volume (veh/h)	82	0	0	0	0	0	0	270	0	0	0	0
Future Volume (Veh/h)	82	0	0	0	0	0	0	270	0	0	0	0
Sign Control		Stop			Stop			Free			Free	
Grade		0%			0%			0%			0%	
Peak Hour Factor	0.76	0.76	0.76	0.76	0.76	0.76	0.76	0.76	0.76	0.76	0.76	0.76
Hourly flow rate (vph)	108	0	0	0	0	0	0	355	0	0	0	0
Pedestrians												
Lane Width (ft)												
Walking Speed (ft/s)												
Percent Blockage												
Right turn flare (veh)												
Median type								None			None	
Median storage (veh)												
Upstream signal (ft)												
pX, platoon unblocked												
vC, conflicting volume	355	355	0	355	355	355	0			355		
vC1, stage 1 conf vol												
vC2, stage 2 conf vol												
vCu, unblocked vol	355	355	0	355	355	355	0			355		
tC, single (s)	7.1	6.5	6.2	7.1	6.5	6.2	4.1			4.1		
tC, 2 stage (s)												
tF (s)	3.5	4.0	3.3	3.5	4.0	3.3	2.2			2.2		
p0 queue free %	82	100	100	100	100	100	100			100		
cM capacity (veh/h)	604	571	1085	600	571	689	1623			1204		
Direction, Lane #	EB 1	NB 1										
Volume Total	108	355										
Volume Left	108	0										
Volume Right	0	0										
cSH	604	1700										
Volume to Capacity	0.18	0.21										
Queue Length 95th (ft)	16	0										
Control Delay (s)	12.3	0.0										
Lane LOS	B											
Approach Delay (s)	12.3	0.0										
Approach LOS	B											
Intersection Summary												
Average Delay			2.9									
Intersection Capacity Utilization			25.4%		ICU Level of Service					A		
Analysis Period (min)			15									

HCM Signalized Intersection Capacity Analysis

2: Westchester Avenue & Blondell Avenue

2018 Existing
PM Peak Hour

												
Movement	NBL	NBT	NBR	SBL	SBT	SBR	NEL	NET	NER	SWL	SWT	SWR
Lane Configurations								 			 	
Traffic Volume (vph)	71	127	110	0	0	0	76	363	0	0	400	82
Future Volume (vph)	71	127	110	0	0	0	76	363	0	0	400	82
Ideal Flow (vphpl)	1900	1900	1900	1900	1900	1900	1900	1900	1900	1900	1900	1900
Lane Width	11	11	16	12	12	12	12	10	11	12	10	12
Total Lost time (s)	5.0	5.0	5.0					5.0			5.0	
Lane Util. Factor	1.00	1.00	1.00					0.95			0.95	
Frt	1.00	1.00	0.85					1.00			0.97	
Flt Protected	0.95	1.00	1.00					0.99			1.00	
Satd. Flow (prot)	1442	1749	1794					2899			3074	
Flt Permitted	0.95	1.00	1.00					0.77			1.00	
Satd. Flow (perm)	1442	1749	1794					2239			3074	
Peak-hour factor, PHF	0.95	0.95	0.95	0.95	0.95	0.95	0.95	0.95	0.95	0.95	0.95	0.95
Adj. Flow (vph)	75	134	116	0	0	0	80	382	0	0	421	86
RTOR Reduction (vph)	0	0	67	0	0	0	0	0	0	0	14	0
Lane Group Flow (vph)	75	134	49	0	0	0	0	462	0	0	493	0
Heavy Vehicles (%)	21%	5%	2%	2%	2%	2%	1%	10%	2%	2%	8%	1%
Bus Blockages (#/hr)	0	0	0	0	0	0	0	2	0	0	0	0
Parking (#/hr)								2				
Turn Type	Split	NA	Perm					NA			NA	
Protected Phases	6!	6!						4!			8	
Permitted Phases			6									
Actuated Green, G (s)	51.0	51.0	51.0					59.0			59.0	
Effective Green, g (s)	51.0	51.0	51.0					59.0			59.0	
Actuated g/C Ratio	0.42	0.42	0.42					0.49			0.49	
Clearance Time (s)	5.0	5.0	5.0					5.0			5.0	
Lane Grp Cap (vph)	612	743	762					1100			1511	
v/s Ratio Prot	0.05	c0.08									0.16	
v/s Ratio Perm			0.03					c0.21				
v/c Ratio	0.12	0.18	0.06					0.42			0.33	
Uniform Delay, d1	20.9	21.5	20.4					19.5			18.5	
Progression Factor	1.00	1.00	1.00					0.47			1.00	
Incremental Delay, d2	0.4	0.5	0.2					1.0			0.6	
Delay (s)	21.3	22.0	20.6					10.1			19.0	
Level of Service	C	C	C					B			B	
Approach Delay (s)		21.3			0.0			10.1			19.0	
Approach LOS		C			A			B			B	
Intersection Summary												
HCM 2000 Control Delay			16.4					HCM 2000 Level of Service			B	
HCM 2000 Volume to Capacity ratio			0.31									
Actuated Cycle Length (s)			120.0					Sum of lost time (s)		10.0		
Intersection Capacity Utilization			45.1%					ICU Level of Service		A		
Analysis Period (min)			15									
! Phase conflict between lane groups.												
c Critical Lane Group												

HCM Signalized Intersection Capacity Analysis
 1: Westchester Square/E Tremont Avenue & Westchester Avenue

2018 Existing
 PM Peak Hour

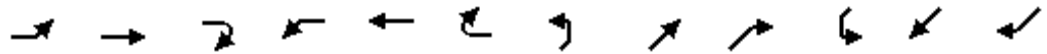

Movement	EBL	EBT	EBR	WBL	WBT	WBR	NEL	NET	NER	SWL	SWT	SWR
Lane Configurations		↑↑			↑↑			↑			↑↑	
Traffic Volume (vph)	14	705	45	0	568	0	0	425	0	0	338	133
Future Volume (vph)	14	705	45	0	568	0	0	425	0	0	338	133
Ideal Flow (vphpl)	1900	1900	1900	1900	1900	1900	1900	1900	1900	1900	1900	1900
Lane Width	12	11	11	12	12	12	12	10	12	12	10	12
Total Lost time (s)		5.0			5.0			5.0			5.0	
Lane Util. Factor		0.95			0.95			1.00			0.95	
Frt		0.99			1.00			1.00			0.96	
Flt Protected		1.00			1.00			1.00			1.00	
Satd. Flow (prot)		3016			3505			1689			2743	
Flt Permitted		0.94			1.00			1.00			1.00	
Satd. Flow (perm)		2833			3505			1689			2743	
Peak-hour factor, PHF	0.93	0.93	0.93	0.93	0.93	0.93	0.93	0.93	0.93	0.93	0.93	0.93
Adj. Flow (vph)	15	758	48	0	611	0	0	457	0	0	363	143
RTOR Reduction (vph)	0	4	0	0	0	0	0	0	0	0	35	0
Lane Group Flow (vph)	0	817	0	0	611	0	0	457	0	0	471	0
Heavy Vehicles (%)	100%	3%	30%	2%	3%	2%	2%	5%	2%	2%	8%	14%
Bus Blockages (#/hr)	0	5	5	0	0	0	0	0	0	0	4	6
Parking (#/hr)		5	5								4	6
Turn Type		NA			NA			NA			NA	
Protected Phases		2!			6!			4!			8!	
Permitted Phases												
Actuated Green, G (s)		51.0			51.0			59.0			59.0	
Effective Green, g (s)		51.0			51.0			59.0			59.0	
Actuated g/C Ratio		0.42			0.42			0.49			0.49	
Clearance Time (s)		5.0			5.0			5.0			5.0	
Lane Grp Cap (vph)		1204			1489			830			1348	
v/s Ratio Prot					0.17			c0.27			0.17	
v/s Ratio Perm		c0.29										
v/c Ratio		6.86dl			0.41			0.55			0.35	
Uniform Delay, d1		27.9			24.0			21.3			18.7	
Progression Factor		1.00			1.00			0.09			0.42	
Incremental Delay, d2		3.1			0.8			2.2			0.7	
Delay (s)		31.0			24.9			4.0			8.5	
Level of Service		C			C			A			A	
Approach Delay (s)		31.0			24.9			4.0			8.5	
Approach LOS		C			C			A			A	

Intersection Summary

HCM 2000 Control Delay	19.5	HCM 2000 Level of Service	B
HCM 2000 Volume to Capacity ratio	0.61		
Actuated Cycle Length (s)	120.0	Sum of lost time (s)	10.0
Intersection Capacity Utilization	61.7%	ICU Level of Service	B
Analysis Period (min)	15		

dl Defacto Left Lane. Recode with 1 though lane as a left lane.

dr Defacto Right Lane. Recode with 1 though lane as a right lane.

! Phase conflict between lane groups.

c Critical Lane Group

HCM Signalized Intersection Capacity Analysis

8: Westchester Avenue

2018 Existing
PM Peak Hour



Movement	WBL	WBR	NET	NER	SWL	SWT
Lane Configurations			↑	↗		↑↑
Traffic Volume (vph)	0	0	425	234	0	383
Future Volume (vph)	0	0	425	234	0	383
Ideal Flow (vphpl)	1900	1900	1900	1900	1900	1900
Lane Width	12	12	10	10	12	10
Total Lost time (s)			5.0	5.0		2.0
Lane Util. Factor			1.00	1.00		0.95
Frt			1.00	0.85		1.00
Flt Protected			1.00	1.00		1.00
Satd. Flow (prot)			1689	1315		3303
Flt Permitted			1.00	1.00		1.00
Satd. Flow (perm)			1689	1315		3303
Peak-hour factor, PHF	0.92	0.92	0.93	0.93	0.92	0.92
Adj. Flow (vph)	0	0	457	252	0	416
RTOR Reduction (vph)	0	0	0	128	0	0
Lane Group Flow (vph)	0	0	457	124	0	416
Heavy Vehicles (%)	2%	2%	5%	2%	2%	2%
Parking (#/hr)				2		
Turn Type			NA	Perm		NA
Protected Phases			4			9
Permitted Phases				4		
Actuated Green, G (s)			59.0	59.0		120.0
Effective Green, g (s)			59.0	59.0		120.0
Actuated g/C Ratio			0.49	0.49		1.00
Clearance Time (s)			5.0	5.0		2.0
Lane Grp Cap (vph)			830	646		3303
v/s Ratio Prot			c0.27			c0.13
v/s Ratio Perm				0.09		
v/c Ratio			0.55	0.19		0.13
Uniform Delay, d1			21.3	17.1		0.0
Progression Factor			1.00	1.00		1.00
Incremental Delay, d2			2.6	0.7		0.1
Delay (s)			23.9	17.8		0.1
Level of Service			C	B		A
Approach Delay (s)	0.0		21.7			0.1
Approach LOS	A		C			A

Intersection Summary

HCM 2000 Control Delay	13.7	HCM 2000 Level of Service	B
HCM 2000 Volume to Capacity ratio	0.36		
Actuated Cycle Length (s)	120.0	Sum of lost time (s)	10.0
Intersection Capacity Utilization	26.5%	ICU Level of Service	A
Analysis Period (min)	15		

c Critical Lane Group

HCM Unsignalized Intersection Capacity Analysis

5: E Tremont & Blondell Avenue

2018 Existing
PM Peak Hour

















Movement	EBL	EBT	WBT	WBR	SBL	SBR
Lane Configurations		↕↕	↕↕			
Traffic Volume (veh/h)	98	841	568	210	0	0
Future Volume (Veh/h)	98	841	568	210	0	0
Sign Control		Free	Free		Stop	
Grade		0%	0%		0%	
Peak Hour Factor	0.92	0.92	0.92	0.92	0.92	0.92
Hourly flow rate (vph)	107	914	617	228	0	0
Pedestrians						
Lane Width (ft)						
Walking Speed (ft/s)						
Percent Blockage						
Right turn flare (veh)						
Median type		None	None			
Median storage (veh)						
Upstream signal (ft)		222				
pX, platoon unblocked					0.80	
vC, conflicting volume	845				1402	422
vC1, stage 1 conf vol						
vC2, stage 2 conf vol						
vCu, unblocked vol	845				998	422
tC, single (s)	4.1				6.8	6.9
tC, 2 stage (s)						
tF (s)	2.2				3.5	3.3
p0 queue free %	86				100	100
cM capacity (veh/h)	787				166	580
Direction, Lane #	EB 1	EB 2	WB 1	WB 2		
Volume Total	412	609	411	434		
Volume Left	107	0	0	0		
Volume Right	0	0	0	228		
cSH	787	1700	1700	1700		
Volume to Capacity	0.14	0.36	0.24	0.26		
Queue Length 95th (ft)	12	0	0	0		
Control Delay (s)	3.9	0.0	0.0	0.0		
Lane LOS	A					
Approach Delay (s)	1.6		0.0			
Approach LOS						
Intersection Summary						
Average Delay			0.9			
Intersection Capacity Utilization			55.2%		ICU Level of Service	B
Analysis Period (min)			15			

HCM Unsignalized Intersection Capacity Analysis

3: Blondell Avenue & Ponton Avenue



















2018 Existing
SAT Peak Hour

												
Movement	EBL	EBT	EBR	WBL	WBT	WBR	NBL	NBT	NBR	SBL	SBT	SBR
Lane Configurations												
Traffic Volume (veh/h)	100	0	0	0	0	0	0	227	0	0	0	0
Future Volume (Veh/h)	100	0	0	0	0	0	0	227	0	0	0	0
Sign Control		Stop			Stop			Free			Free	
Grade		0%			0%			0%			0%	
Peak Hour Factor	0.93	0.93	0.93	0.93	0.93	0.93	0.93	0.93	0.93	0.93	0.93	0.93
Hourly flow rate (vph)	108	0	0	0	0	0	0	244	0	0	0	0
Pedestrians												
Lane Width (ft)												
Walking Speed (ft/s)												
Percent Blockage												
Right turn flare (veh)												
Median type								None			None	
Median storage (veh)												
Upstream signal (ft)												
pX, platoon unblocked												
vC, conflicting volume	244	244	0	244	244	244	0			244		
vC1, stage 1 conf vol												
vC2, stage 2 conf vol												
vCu, unblocked vol	244	244	0	244	244	244	0			244		
tC, single (s)	7.1	6.5	6.2	7.1	6.5	6.2	4.1			4.1		
tC, 2 stage (s)												
tF (s)	3.5	4.0	3.3	3.5	4.0	3.3	2.2			2.2		
p0 queue free %	85	100	100	100	100	100	100			100		
cM capacity (veh/h)	708	658	1085	710	658	795	1623			1322		
Direction, Lane #	EB 1	NB 1										
Volume Total	108	244										
Volume Left	108	0										
Volume Right	0	0										
cSH	708	1700										
Volume to Capacity	0.15	0.14										
Queue Length 95th (ft)	13	0										
Control Delay (s)	11.0	0.0										
Lane LOS	B											
Approach Delay (s)	11.0	0.0										
Approach LOS	B											
Intersection Summary												
Average Delay			3.4									
Intersection Capacity Utilization			24.2%			ICU Level of Service				A		
Analysis Period (min)			15									

HCM Signalized Intersection Capacity Analysis

2: Blondell Avenue & Westchester Avenue















2018 Existing
SAT Peak Hour

												
Movement	NBL	NBT	NBR	SBL	SBT	SBR	NEL	NET	NER	SWL	SWT	SWR
Lane Configurations								 			 	
Traffic Volume (vph)	94	124	112	0	0	0	62	265	0	0	380	59
Future Volume (vph)	94	124	112	0	0	0	62	265	0	0	380	59
Ideal Flow (vphpl)	1900	1900	1900	1900	1900	1900	1900	1900	1900	1900	1900	1900
Lane Width	11	11	16	12	12	12	12	10	11	12	10	12
Total Lost time (s)	5.0	5.0	5.0					5.0			5.0	
Lane Util. Factor	1.00	1.00	1.00					0.95			0.95	
Frt	1.00	1.00	0.85					1.00			0.98	
Flt Protected	0.95	1.00	1.00					0.99			1.00	
Satd. Flow (prot)	1728	1801	1794					2994			3183	
Flt Permitted	0.95	1.00	1.00					0.80			1.00	
Satd. Flow (perm)	1728	1801	1794					2409			3183	
Peak-hour factor, PHF	0.95	0.95	0.95	0.95	0.95	0.95	0.95	0.95	0.95	0.95	0.95	0.95
Adj. Flow (vph)	99	131	118	0	0	0	65	279	0	0	400	62
RTOR Reduction (vph)	0	0	71	0	0	0	0	0	0	0	14	0
Lane Group Flow (vph)	99	131	47	0	0	0	0	344	0	0	448	0
Heavy Vehicles (%)	1%	2%	2%	2%	2%	2%	3%	6%	2%	2%	4%	2%
Bus Blockages (#/hr)	0	0	0	0	0	0	0	1	0	0	0	0
Parking (#/hr)								1				
Turn Type	Split	NA	Perm					NA			NA	
Protected Phases	6!	6!						4!			8	
Permitted Phases			6									
Actuated Green, G (s)	36.0	36.0	36.0					44.0			44.0	
Effective Green, g (s)	36.0	36.0	36.0					44.0			44.0	
Actuated g/C Ratio	0.40	0.40	0.40					0.49			0.49	
Clearance Time (s)	5.0	5.0	5.0					5.0			5.0	
Lane Grp Cap (vph)	691	720	717					1177			1556	
v/s Ratio Prot	0.06	c0.07									0.14	
v/s Ratio Perm			0.03					c0.14				
v/c Ratio	0.14	0.18	0.07					0.29			0.29	
Uniform Delay, d1	17.2	17.5	16.6					13.7			13.7	
Progression Factor	1.00	1.00	1.00					1.00			1.00	
Incremental Delay, d2	0.4	0.6	0.2					0.6			0.5	
Delay (s)	17.6	18.0	16.8					14.3			14.1	
Level of Service	B	B	B					B			B	
Approach Delay (s)		17.5			0.0			14.3			14.1	
Approach LOS		B			A			B			B	
Intersection Summary												
HCM 2000 Control Delay			15.2					HCM 2000 Level of Service			B	
HCM 2000 Volume to Capacity ratio			0.24									
Actuated Cycle Length (s)			90.0					Sum of lost time (s)		10.0		
Intersection Capacity Utilization			40.5%					ICU Level of Service		A		
Analysis Period (min)			15									
! Phase conflict between lane groups.												
c Critical Lane Group												

HCM Unsignalized Intersection Capacity Analysis

3: Blondell Avenue & Ponton Avenue/Site Driveway

2029 No Build
AM Peak Hour

												
Movement	EBL	EBT	EBR	WBL	WBT	WBR	NBL	NBT	NBR	SBL	SBT	SBR
Lane Configurations												
Traffic Volume (veh/h)	72	0	0	0	0	0	0	408	0	0	0	0
Future Volume (Veh/h)	72	0	0	0	0	0	0	408	0	0	0	0
Sign Control		Stop			Stop			Free			Free	
Grade		0%			0%			0%			0%	
Peak Hour Factor	0.89	0.89	0.89	0.92	0.92	0.92	0.92	0.92	0.92	0.92	0.92	0.92
Hourly flow rate (vph)	81	0	0	0	0	0	0	443	0	0	0	0
Pedestrians												
Lane Width (ft)												
Walking Speed (ft/s)												
Percent Blockage												
Right turn flare (veh)												
Median type								None			None	
Median storage (veh)												
Upstream signal (ft)								530				
pX, platoon unblocked												
vC, conflicting volume	443	443	0	443	443	443	0			443		
vC1, stage 1 conf vol												
vC2, stage 2 conf vol												
vCu, unblocked vol	443	443	0	443	443	443	0			443		
tC, single (s)	7.2	6.5	6.2	7.1	6.5	6.2	4.1			4.1		
tC, 2 stage (s)												
tF (s)	3.6	4.0	3.3	3.5	4.0	3.3	2.2			2.2		
p0 queue free %	84	100	100	100	100	100	100			100		
cM capacity (veh/h)	518	509	1085	525	509	615	1623			1117		
Direction, Lane #	EB 1	NB 1										
Volume Total	81	443										
Volume Left	81	0										
Volume Right	0	0										
cSH	518	1700										
Volume to Capacity	0.16	0.26										
Queue Length 95th (ft)	14	0										
Control Delay (s)	13.2	0.0										
Lane LOS	B											
Approach Delay (s)	13.2	0.0										
Approach LOS	B											
Intersection Summary												
Average Delay			2.0									
Intersection Capacity Utilization			32.1%		ICU Level of Service					A		
Analysis Period (min)			15									

HCM Unsignalized Intersection Capacity Analysis

4: Blondell Avenue & St Raymond Avenue

2029 No Build
AM Peak Hour

















Movement	EBL	EBR	NBL	NBT	SBT	SBR
Lane Configurations	↶			↷		
Traffic Volume (veh/h)	38	0	38	418	0	0
Future Volume (Veh/h)	38	0	38	418	0	0
Sign Control	Stop			Free	Free	
Grade	0%			0%	0%	
Peak Hour Factor	0.92	0.92	0.92	0.92	0.92	0.92
Hourly flow rate (vph)	41	0	41	454	0	0
Pedestrians						
Lane Width (ft)						
Walking Speed (ft/s)						
Percent Blockage						
Right turn flare (veh)						
Median type				None	None	
Median storage (veh)						
Upstream signal (ft)						
pX, platoon unblocked						
vC, conflicting volume	536	0	0			
vC1, stage 1 conf vol						
vC2, stage 2 conf vol						
vCu, unblocked vol	536	0	0			
tC, single (s)	6.4	6.2	4.1			
tC, 2 stage (s)						
tF (s)	3.5	3.3	2.2			
p0 queue free %	92	100	97			
cM capacity (veh/h)	491	1085	1617			
Direction, Lane #	EB 1	NB 1				
Volume Total	41	495				
Volume Left	41	41				
Volume Right	0	0				
cSH	491	1617				
Volume to Capacity	0.08	0.03				
Queue Length 95th (ft)	7	2				
Control Delay (s)	13.0	0.8				
Lane LOS	B	A				
Approach Delay (s)	13.0	0.8				
Approach LOS	B					
Intersection Summary						
Average Delay			1.8			
Intersection Capacity Utilization			34.1%	ICU Level of Service	A	
Analysis Period (min)			15			

HCM Unsignalized Intersection Capacity Analysis

3: Ponton Avenue/Site Driveway & Blondell Avenue



















2029 No Build
PM Peak Hour

												
Movement	EBL	EBT	EBR	WBL	WBT	WBR	NBL	NBT	NBR	SBL	SBT	SBR
Lane Configurations												
Traffic Volume (veh/h)	84	0	0	0	0	0	0	278	0	0	0	0
Future Volume (Veh/h)	84	0	0	0	0	0	0	278	0	0	0	0
Sign Control		Stop			Stop			Free			Free	
Grade		0%			0%			0%			0%	
Peak Hour Factor	0.76	0.76	0.76	0.76	0.76	0.76	0.76	0.76	0.76	0.76	0.76	0.76
Hourly flow rate (vph)	111	0	0	0	0	0	0	366	0	0	0	0
Pedestrians												
Lane Width (ft)												
Walking Speed (ft/s)												
Percent Blockage												
Right turn flare (veh)												
Median type								None			None	
Median storage (veh)												
Upstream signal (ft)								530				
pX, platoon unblocked												
vC, conflicting volume	366	366	0	366	366	366	0			366		
vC1, stage 1 conf vol												
vC2, stage 2 conf vol												
vCu, unblocked vol	366	366	0	366	366	366	0			366		
tC, single (s)	7.1	6.5	6.2	7.1	6.5	6.2	4.1			4.1		
tC, 2 stage (s)												
tF (s)	3.5	4.0	3.3	3.5	4.0	3.3	2.2			2.2		
p0 queue free %	81	100	100	100	100	100	100			100		
cM capacity (veh/h)	594	562	1085	590	562	679	1623			1193		
Direction, Lane #	EB 1	NB 1										
Volume Total	111	366										
Volume Left	111	0										
Volume Right	0	0										
cSH	594	1700										
Volume to Capacity	0.19	0.22										
Queue Length 95th (ft)	17	0										
Control Delay (s)	12.4	0.0										
Lane LOS	B											
Approach Delay (s)	12.4	0.0										
Approach LOS	B											
Intersection Summary												
Average Delay			2.9									
Intersection Capacity Utilization			26.0%		ICU Level of Service					A		
Analysis Period (min)			15									

HCM Signalized Intersection Capacity Analysis

2: Westchester Avenue & Blondell Avenue

2029 No Build
PM Peak Hour

												
Movement	NBL	NBT	NBR	SBL	SBT	SBR	NEL	NET	NER	SWL	SWT	SWR
Lane Configurations								 			 	
Traffic Volume (vph)	73	131	113	0	0	0	78	373	0	0	411	84
Future Volume (vph)	73	131	113	0	0	0	78	373	0	0	411	84
Ideal Flow (vphpl)	1900	1900	1900	1900	1900	1900	1900	1900	1900	1900	1900	1900
Lane Width	11	11	16	12	12	12	12	10	11	12	10	12
Total Lost time (s)	5.0	5.0	5.0					5.0			5.0	
Lane Util. Factor	1.00	1.00	1.00					0.95			0.95	
Frt	1.00	1.00	0.85					1.00			0.97	
Flt Protected	0.95	1.00	1.00					0.99			1.00	
Satd. Flow (prot)	1442	1749	1794					2899			3074	
Flt Permitted	0.95	1.00	1.00					0.76			1.00	
Satd. Flow (perm)	1442	1749	1794					2214			3074	
Peak-hour factor, PHF	0.95	0.95	0.95	0.95	0.95	0.95	0.95	0.95	0.95	0.95	0.95	0.95
Adj. Flow (vph)	77	138	119	0	0	0	82	393	0	0	433	88
RTOR Reduction (vph)	0	0	68	0	0	0	0	0	0	0	14	0
Lane Group Flow (vph)	77	138	51	0	0	0	0	475	0	0	507	0
Heavy Vehicles (%)	21%	5%	2%	2%	2%	2%	1%	10%	2%	2%	8%	1%
Bus Blockages (#/hr)	0	0	0	0	0	0	0	2	0	0	0	0
Parking (#/hr)								2				
Turn Type	Split	NA	Perm					NA			NA	
Protected Phases	6!	6!						4!			8	
Permitted Phases			6									
Actuated Green, G (s)	51.0	51.0	51.0					59.0			59.0	
Effective Green, g (s)	51.0	51.0	51.0					59.0			59.0	
Actuated g/C Ratio	0.42	0.42	0.42					0.49			0.49	
Clearance Time (s)	5.0	5.0	5.0					5.0			5.0	
Lane Grp Cap (vph)	612	743	762					1088			1511	
v/s Ratio Prot	0.05	c0.08									0.16	
v/s Ratio Perm			0.03					c0.21				
v/c Ratio	0.13	0.19	0.07					0.44			0.34	
Uniform Delay, d1	21.0	21.5	20.4					19.7			18.6	
Progression Factor	1.00	1.00	1.00					0.46			1.00	
Incremental Delay, d2	0.4	0.6	0.2					1.0			0.6	
Delay (s)	21.4	22.1	20.6					10.1			19.2	
Level of Service	C	C	C					B			B	
Approach Delay (s)		21.4			0.0			10.1			19.2	
Approach LOS		C			A			B			B	
Intersection Summary												
HCM 2000 Control Delay			16.5					HCM 2000 Level of Service			B	
HCM 2000 Volume to Capacity ratio			0.32									
Actuated Cycle Length (s)			120.0					Sum of lost time (s)		10.0		
Intersection Capacity Utilization			46.0%					ICU Level of Service		A		
Analysis Period (min)			15									
! Phase conflict between lane groups.												
c Critical Lane Group												

HCM Signalized Intersection Capacity Analysis
 1: Westchester Square/E Tremont Avenue & Westchester Avenue

2029 No Build
 PM Peak Hour

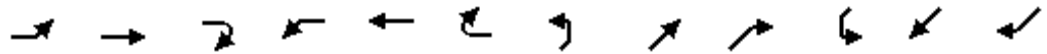

Movement	EBL	EBT	EBR	WBL	WBT	WBR	NEL	NET	NER	SWL	SWT	SWR
Lane Configurations		↑↑			↑↑			↑			↑↑	
Traffic Volume (vph)	14	725	46	0	584	0	0	437	0	0	347	137
Future Volume (vph)	14	725	46	0	584	0	0	437	0	0	347	137
Ideal Flow (vphpl)	1900	1900	1900	1900	1900	1900	1900	1900	1900	1900	1900	1900
Lane Width	12	11	11	12	12	12	12	10	12	12	10	12
Total Lost time (s)		5.0			5.0			5.0			5.0	
Lane Util. Factor		0.95			0.95			1.00			0.95	
Frt		0.99			1.00			1.00			0.96	
Flt Protected		1.00			1.00			1.00			1.00	
Satd. Flow (prot)		3018			3505			1689			2743	
Flt Permitted		0.94			1.00			1.00			1.00	
Satd. Flow (perm)		2834			3505			1689			2743	
Peak-hour factor, PHF	0.93	0.93	0.93	0.93	0.93	0.93	0.93	0.93	0.93	0.93	0.93	0.93
Adj. Flow (vph)	15	780	49	0	628	0	0	470	0	0	373	147
RTOR Reduction (vph)	0	3	0	0	0	0	0	0	0	0	35	0
Lane Group Flow (vph)	0	841	0	0	628	0	0	470	0	0	485	0
Heavy Vehicles (%)	100%	3%	30%	2%	3%	2%	2%	5%	2%	2%	8%	14%
Bus Blockages (#/hr)	0	5	5	0	0	0	0	0	0	0	4	6
Parking (#/hr)		5	5								4	6
Turn Type		NA			NA			NA			NA	
Protected Phases		2!			6!			4!			8!	
Permitted Phases												
Actuated Green, G (s)		51.0			51.0			59.0			59.0	
Effective Green, g (s)		51.0			51.0			59.0			59.0	
Actuated g/C Ratio		0.42			0.42			0.49			0.49	
Clearance Time (s)		5.0			5.0			5.0			5.0	
Lane Grp Cap (vph)		1204			1489			830			1348	
v/s Ratio Prot					0.18			c0.28			0.18	
v/s Ratio Perm		c0.30										
v/c Ratio		8.17dl			0.42			0.57			0.36	
Uniform Delay, d1		28.2			24.2			21.5			18.8	
Progression Factor		1.00			1.00			0.08			0.42	
Incremental Delay, d2		3.4			0.9			2.3			0.7	
Delay (s)		31.6			25.0			4.1			8.6	
Level of Service		C			C			A			A	
Approach Delay (s)		31.6			25.0			4.1			8.6	
Approach LOS		C			C			A			A	

Intersection Summary

HCM 2000 Control Delay	19.8	HCM 2000 Level of Service	B
HCM 2000 Volume to Capacity ratio	0.63		
Actuated Cycle Length (s)	120.0	Sum of lost time (s)	10.0
Intersection Capacity Utilization	62.9%	ICU Level of Service	B
Analysis Period (min)	15		

dl Defacto Left Lane. Recode with 1 though lane as a left lane.

dr Defacto Right Lane. Recode with 1 though lane as a right lane.

! Phase conflict between lane groups.

c Critical Lane Group

HCM Signalized Intersection Capacity Analysis

8: Westchester Avenue

2029 No Build
PM Peak Hour



Movement	WBL	WBR	NET	NER	SWL	SWT
Lane Configurations			↑	↗		↑↑
Traffic Volume (vph)	0	0	437	241	0	393
Future Volume (vph)	0	0	437	241	0	393
Ideal Flow (vphpl)	1900	1900	1900	1900	1900	1900
Lane Width	12	12	10	10	12	10
Total Lost time (s)			5.0	5.0		2.0
Lane Util. Factor			1.00	1.00		0.95
Frt			1.00	0.85		1.00
Flt Protected			1.00	1.00		1.00
Satd. Flow (prot)			1689	1315		3303
Flt Permitted			1.00	1.00		1.00
Satd. Flow (perm)			1689	1315		3303
Peak-hour factor, PHF	0.93	0.93	0.93	0.93	0.93	0.93
Adj. Flow (vph)	0	0	470	259	0	423
RTOR Reduction (vph)	0	0	0	132	0	0
Lane Group Flow (vph)	0	0	470	127	0	423
Heavy Vehicles (%)	2%	2%	5%	2%	2%	2%
Parking (#/hr)				2		
Turn Type			NA	Perm		NA
Protected Phases			4			9
Permitted Phases				4		
Actuated Green, G (s)			59.0	59.0		120.0
Effective Green, g (s)			59.0	59.0		120.0
Actuated g/C Ratio			0.49	0.49		1.00
Clearance Time (s)			5.0	5.0		2.0
Lane Grp Cap (vph)			830	646		3303
v/s Ratio Prot			c0.28			c0.13
v/s Ratio Perm				0.10		
v/c Ratio			0.57	0.20		0.13
Uniform Delay, d1			21.5	17.2		0.0
Progression Factor			1.00	1.00		1.00
Incremental Delay, d2			2.8	0.7		0.1
Delay (s)			24.3	17.9		0.1
Level of Service			C	B		A
Approach Delay (s)	0.0		22.0			0.1
Approach LOS	A		C			A

Intersection Summary

HCM 2000 Control Delay	13.9	HCM 2000 Level of Service	B
HCM 2000 Volume to Capacity ratio	0.37		
Actuated Cycle Length (s)	120.0	Sum of lost time (s)	10.0
Intersection Capacity Utilization	27.2%	ICU Level of Service	A
Analysis Period (min)	15		

c Critical Lane Group

HCM Unsignalized Intersection Capacity Analysis

5: E Tremont & Blondell Avenue

2029 No Build
PM Peak Hour

















Movement	EBL	EBT	WBT	WBR	SBL	SBR
Lane Configurations		↕↕	↕↕			
Traffic Volume (veh/h)	101	865	584	216	0	0
Future Volume (Veh/h)	101	865	584	216	0	0
Sign Control		Free	Free		Stop	
Grade		0%	0%		0%	
Peak Hour Factor	0.92	0.92	0.92	0.92	0.92	0.92
Hourly flow rate (vph)	110	940	635	235	0	0
Pedestrians						
Lane Width (ft)						
Walking Speed (ft/s)						
Percent Blockage						
Right turn flare (veh)						
Median type		None	None			
Median storage (veh)						
Upstream signal (ft)		222				
pX, platoon unblocked					0.79	
vC, conflicting volume	870				1442	435
vC1, stage 1 conf vol						
vC2, stage 2 conf vol						
vCu, unblocked vol	870				1028	435
tC, single (s)	4.1				6.8	6.9
tC, 2 stage (s)						
tF (s)	2.2				3.5	3.3
p0 queue free %	86				100	100
cM capacity (veh/h)	770				156	569
Direction, Lane #	EB 1	EB 2	WB 1	WB 2		
Volume Total	423	627	423	447		
Volume Left	110	0	0	0		
Volume Right	0	0	0	235		
cSH	770	1700	1700	1700		
Volume to Capacity	0.14	0.37	0.25	0.26		
Queue Length 95th (ft)	12	0	0	0		
Control Delay (s)	4.1	0.0	0.0	0.0		
Lane LOS	A					
Approach Delay (s)	1.6		0.0			
Approach LOS						
Intersection Summary						
Average Delay			0.9			
Intersection Capacity Utilization			56.6%		ICU Level of Service	B
Analysis Period (min)			15			

HCM Unsignalized Intersection Capacity Analysis

3: Blondell Avenue & Ponton Avenue



















2029 No Build
SAT Peak Hour

												
Movement	EBL	EBT	EBR	WBL	WBT	WBR	NBL	NBT	NBR	SBL	SBT	SBR
Lane Configurations												
Traffic Volume (veh/h)	103	0	0	0	0	0	0	233	0	0	0	0
Future Volume (Veh/h)	103	0	0	0	0	0	0	233	0	0	0	0
Sign Control		Stop			Stop			Free			Free	
Grade		0%			0%			0%			0%	
Peak Hour Factor	0.93	0.93	0.93	0.93	0.93	0.93	0.93	0.93	0.93	0.93	0.93	0.93
Hourly flow rate (vph)	111	0	0	0	0	0	0	251	0	0	0	0
Pedestrians												
Lane Width (ft)												
Walking Speed (ft/s)												
Percent Blockage												
Right turn flare (veh)												
Median type								None			None	
Median storage (veh)												
Upstream signal (ft)												
pX, platoon unblocked												
vC, conflicting volume	251	251	0	251	251	251	0			251		
vC1, stage 1 conf vol												
vC2, stage 2 conf vol												
vCu, unblocked vol	251	251	0	251	251	251	0			251		
tC, single (s)	7.1	6.5	6.2	7.1	6.5	6.2	4.1			4.1		
tC, 2 stage (s)												
tF (s)	3.5	4.0	3.3	3.5	4.0	3.3	2.2			2.2		
p0 queue free %	84	100	100	100	100	100	100			100		
cM capacity (veh/h)	700	652	1085	702	652	788	1623			1314		
Direction, Lane #	EB 1	NB 1										
Volume Total	111	251										
Volume Left	111	0										
Volume Right	0	0										
cSH	700	1700										
Volume to Capacity	0.16	0.15										
Queue Length 95th (ft)	14	0										
Control Delay (s)	11.1	0.0										
Lane LOS	B											
Approach Delay (s)	11.1	0.0										
Approach LOS	B											
Intersection Summary												
Average Delay			3.4									
Intersection Capacity Utilization			24.6%			ICU Level of Service				A		
Analysis Period (min)			15									

HCM Signalized Intersection Capacity Analysis















2: Blondell Avenue & Westchester Avenue

2029 No Build
SAT Peak Hour

												
Movement	NBL	NBT	NBR	SBL	SBT	SBR	NEL	NET	NER	SWL	SWT	SWR
Lane Configurations								 			 	
Traffic Volume (vph)	97	127	115	0	0	0	64	272	0	0	391	61
Future Volume (vph)	97	127	115	0	0	0	64	272	0	0	391	61
Ideal Flow (vphpl)	1900	1900	1900	1900	1900	1900	1900	1900	1900	1900	1900	1900
Lane Width	11	11	16	12	12	12	12	10	11	12	10	12
Total Lost time (s)	5.0	5.0	5.0					5.0			5.0	
Lane Util. Factor	1.00	1.00	1.00					0.95			0.95	
Frt	1.00	1.00	0.85					1.00			0.98	
Flt Protected	0.95	1.00	1.00					0.99			1.00	
Satd. Flow (prot)	1728	1801	1794					2994			3183	
Flt Permitted	0.95	1.00	1.00					0.79			1.00	
Satd. Flow (perm)	1728	1801	1794					2392			3183	
Peak-hour factor, PHF	0.95	0.95	0.95	0.95	0.95	0.95	0.95	0.95	0.95	0.95	0.95	0.95
Adj. Flow (vph)	102	134	121	0	0	0	67	286	0	0	412	64
RTOR Reduction (vph)	0	0	73	0	0	0	0	0	0	0	14	0
Lane Group Flow (vph)	102	134	48	0	0	0	0	353	0	0	462	0
Heavy Vehicles (%)	1%	2%	2%	2%	2%	2%	3%	6%	2%	2%	4%	2%
Bus Blockages (#/hr)	0	0	0	0	0	0	0	1	0	0	0	0
Parking (#/hr)								1				
Turn Type	Split	NA	Perm					NA			NA	
Protected Phases	6!	6!						4!			8	
Permitted Phases			6									
Actuated Green, G (s)	36.0	36.0	36.0					44.0			44.0	
Effective Green, g (s)	36.0	36.0	36.0					44.0			44.0	
Actuated g/C Ratio	0.40	0.40	0.40					0.49			0.49	
Clearance Time (s)	5.0	5.0	5.0					5.0			5.0	
Lane Grp Cap (vph)	691	720	717					1169			1556	
v/s Ratio Prot	0.06	c0.07									0.15	
v/s Ratio Perm			0.03					c0.15				
v/c Ratio	0.15	0.19	0.07					0.30			0.30	
Uniform Delay, d1	17.2	17.5	16.6					13.8			13.8	
Progression Factor	1.00	1.00	1.00					1.00			1.00	
Incremental Delay, d2	0.5	0.6	0.2					0.7			0.5	
Delay (s)	17.7	18.1	16.8					14.5			14.2	
Level of Service	B	B	B					B			B	
Approach Delay (s)		17.5			0.0			14.5			14.2	
Approach LOS		B			A			B			B	
Intersection Summary												
HCM 2000 Control Delay			15.3					HCM 2000 Level of Service			B	
HCM 2000 Volume to Capacity ratio			0.25									
Actuated Cycle Length (s)			90.0					Sum of lost time (s)		10.0		
Intersection Capacity Utilization			41.3%					ICU Level of Service		A		
Analysis Period (min)			15									
! Phase conflict between lane groups.												
c Critical Lane Group												

HCM Unsignalized Intersection Capacity Analysis
 3: Blondell Avenue & Ponton Avenue/Site Driveway

2029 Build
 AM Peak Hour

												
Movement	EBL	EBT	EBR	WBL	WBT	WBR	NBL	NBT	NBR	SBL	SBT	SBR
Lane Configurations												
Traffic Volume (veh/h)	72	0	0	0	0	49	0	414	11	0	0	0
Future Volume (Veh/h)	72	0	0	0	0	49	0	414	11	0	0	0
Sign Control		Stop			Stop			Free			Free	
Grade		0%			0%			0%			0%	
Peak Hour Factor	0.89	0.89	0.89	0.92	0.92	0.92	0.92	0.92	0.92	0.92	0.92	0.92
Hourly flow rate (vph)	81	0	0	0	0	53	0	450	12	0	0	0
Pedestrians												
Lane Width (ft)												
Walking Speed (ft/s)												
Percent Blockage												
Right turn flare (veh)												
Median type								None			None	
Median storage (veh)												
Upstream signal (ft)								530				
pX, platoon unblocked												
vC, conflicting volume	509	462	0	456	456	456	0			462		
vC1, stage 1 conf vol												
vC2, stage 2 conf vol												
vCu, unblocked vol	509	462	0	456	456	456	0			462		
tC, single (s)	7.2	6.5	6.2	7.1	6.5	6.2	4.1			4.1		
tC, 2 stage (s)												
tF (s)	3.6	4.0	3.3	3.5	4.0	3.3	2.2			2.2		
p0 queue free %	81	100	100	100	100	91	100			100		
cM capacity (veh/h)	427	497	1085	515	501	604	1623			1099		
Direction, Lane #	EB 1	WB 1	NB 1									
Volume Total	81	53	462									
Volume Left	81	0	0									
Volume Right	0	53	12									
cSH	427	604	1700									
Volume to Capacity	0.19	0.09	0.27									
Queue Length 95th (ft)	17	7	0									
Control Delay (s)	15.4	11.5	0.0									
Lane LOS	C	B										
Approach Delay (s)	15.4	11.5	0.0									
Approach LOS	C	B										
Intersection Summary												
Average Delay			3.1									
Intersection Capacity Utilization			39.8%		ICU Level of Service				A			
Analysis Period (min)			15									

HCM Unsignalized Intersection Capacity Analysis

4: Blondell Avenue & St Raymond Avenue

2029 Build
AM Peak Hour

















Movement	EBL	EBR	NBL	NBT	SBT	SBR
Lane Configurations	↶			↷		
Traffic Volume (veh/h)	38	0	80	431	0	0
Future Volume (Veh/h)	38	0	80	431	0	0
Sign Control	Stop			Free	Free	
Grade	0%			0%	0%	
Peak Hour Factor	0.92	0.92	0.92	0.92	0.92	0.92
Hourly flow rate (vph)	41	0	87	468	0	0
Pedestrians						
Lane Width (ft)						
Walking Speed (ft/s)						
Percent Blockage						
Right turn flare (veh)						
Median type				None	None	
Median storage (veh)						
Upstream signal (ft)						
pX, platoon unblocked						
vC, conflicting volume	642	0	0			
vC1, stage 1 conf vol						
vC2, stage 2 conf vol						
vCu, unblocked vol	642	0	0			
tC, single (s)	6.4	6.2	4.1			
tC, 2 stage (s)						
tF (s)	3.5	3.3	2.2			
p0 queue free %	90	100	95			
cM capacity (veh/h)	413	1085	1617			
Direction, Lane #	EB 1	NB 1				
Volume Total	41	555				
Volume Left	41	87				
Volume Right	0	0				
cSH	413	1617				
Volume to Capacity	0.10	0.05				
Queue Length 95th (ft)	8	4				
Control Delay (s)	14.7	1.6				
Lane LOS	B	A				
Approach Delay (s)	14.7	1.6				
Approach LOS	B					
Intersection Summary						
Average Delay			2.5			
Intersection Capacity Utilization			37.1%	ICU Level of Service	A	
Analysis Period (min)			15			

HCM Unsignalized Intersection Capacity Analysis

3: Ponton Avenue/Site Driveway & Blondell Avenue



















2029 Build
PM Peak Hour

												
Movement	EBL	EBT	EBR	WBL	WBT	WBR	NBL	NBT	NBR	SBL	SBT	SBR
Lane Configurations												
Traffic Volume (veh/h)	84	0	0	0	0	20	0	286	46	0	0	0
Future Volume (Veh/h)	84	0	0	0	0	20	0	286	46	0	0	0
Sign Control		Stop			Stop			Free			Free	
Grade		0%			0%			0%			0%	
Peak Hour Factor	0.76	0.76	0.76	0.76	0.76	0.76	0.76	0.76	0.76	0.76	0.76	0.76
Hourly flow rate (vph)	111	0	0	0	0	26	0	376	61	0	0	0
Pedestrians												
Lane Width (ft)												
Walking Speed (ft/s)												
Percent Blockage												
Right turn flare (veh)												
Median type								None			None	
Median storage (veh)												
Upstream signal (ft)								530				
pX, platoon unblocked												
vC, conflicting volume	432	437	0	406	406	406	0			437		
vC1, stage 1 conf vol												
vC2, stage 2 conf vol												
vCu, unblocked vol	432	437	0	406	406	406	0			437		
tC, single (s)	7.1	6.5	6.2	7.1	6.5	6.2	4.1			4.1		
tC, 2 stage (s)												
tF (s)	3.5	4.0	3.3	3.5	4.0	3.3	2.2			2.2		
p0 queue free %	78	100	100	100	100	96	100			100		
cM capacity (veh/h)	515	513	1085	555	534	644	1623			1123		
Direction, Lane #	EB 1	WB 1	NB 1									
Volume Total	111	26	437									
Volume Left	111	0	0									
Volume Right	0	26	61									
cSH	515	644	1700									
Volume to Capacity	0.22	0.04	0.26									
Queue Length 95th (ft)	20	3	0									
Control Delay (s)	13.9	10.8	0.0									
Lane LOS	B	B										
Approach Delay (s)	13.9	10.8	0.0									
Approach LOS	B	B										
Intersection Summary												
Average Delay			3.2									
Intersection Capacity Utilization			35.8%			ICU Level of Service				A		
Analysis Period (min)			15									

HCM Signalized Intersection Capacity Analysis

2: Westchester Avenue & Blondell Avenue

2029 Build
PM Peak Hour

												
Movement	NBL	NBT	NBR	SBL	SBT	SBR	NEL	NET	NER	SWL	SWT	SWR
Lane Configurations								 			 	
Traffic Volume (vph)	73	164	131	0	0	0	88	375	0	0	412	95
Future Volume (vph)	73	164	131	0	0	0	88	375	0	0	412	95
Ideal Flow (vphpl)	1900	1900	1900	1900	1900	1900	1900	1900	1900	1900	1900	1900
Lane Width	11	11	16	12	12	12	12	10	11	12	10	12
Total Lost time (s)	5.0	5.0	5.0					5.0			5.0	
Lane Util. Factor	1.00	1.00	1.00					0.95			0.95	
Frt	1.00	1.00	0.85					1.00			0.97	
Flt Protected	0.95	1.00	1.00					0.99			1.00	
Satd. Flow (prot)	1442	1749	1794					2901			3069	
Flt Permitted	0.95	1.00	1.00					0.72			1.00	
Satd. Flow (perm)	1442	1749	1794					2122			3069	
Peak-hour factor, PHF	0.95	0.95	0.95	0.95	0.95	0.95	0.95	0.95	0.95	0.95	0.95	0.95
Adj. Flow (vph)	77	173	138	0	0	0	93	395	0	0	434	100
RTOR Reduction (vph)	0	0	79	0	0	0	0	0	0	0	17	0
Lane Group Flow (vph)	77	173	59	0	0	0	0	488	0	0	517	0
Heavy Vehicles (%)	21%	5%	2%	2%	2%	2%	1%	10%	2%	2%	8%	1%
Bus Blockages (#/hr)	0	0	0	0	0	0	0	2	0	0	0	0
Parking (#/hr)								2				
Turn Type	Split	NA	Perm					NA			NA	
Protected Phases	6!	6!						4!			8	
Permitted Phases			6									
Actuated Green, G (s)	51.0	51.0	51.0					59.0			59.0	
Effective Green, g (s)	51.0	51.0	51.0					59.0			59.0	
Actuated g/C Ratio	0.42	0.42	0.42					0.49			0.49	
Clearance Time (s)	5.0	5.0	5.0					5.0			5.0	
Lane Grp Cap (vph)	612	743	762					1043			1508	
v/s Ratio Prot	0.05	c0.10									0.17	
v/s Ratio Perm			0.03					c0.23				
v/c Ratio	0.13	0.23	0.08					0.47			0.34	
Uniform Delay, d1	21.0	22.0	20.5					20.1			18.6	
Progression Factor	1.00	1.00	1.00					0.45			1.00	
Incremental Delay, d2	0.4	0.7	0.2					1.2			0.6	
Delay (s)	21.4	22.7	20.7					10.2			19.3	
Level of Service	C	C	C					B			B	
Approach Delay (s)		21.8			0.0			10.2			19.3	
Approach LOS		C			A			B			B	
Intersection Summary												
HCM 2000 Control Delay			16.8					HCM 2000 Level of Service			B	
HCM 2000 Volume to Capacity ratio			0.36									
Actuated Cycle Length (s)			120.0					Sum of lost time (s)		10.0		
Intersection Capacity Utilization			48.5%					ICU Level of Service		A		
Analysis Period (min)			15									
! Phase conflict between lane groups.												
c Critical Lane Group												

HCM Signalized Intersection Capacity Analysis

1: Westchester Square/E Tremont Avenue & Westchester Avenue

2029 Build
PM Peak Hour

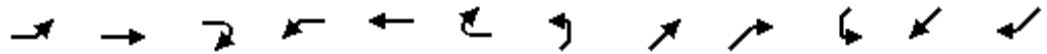

Movement	EBL	EBT	EBR	WBL	WBT	WBR	NEL	NET	NER	SWL	SWT	SWR
Lane Configurations		↑↑			↑↑			↑			↑↑	
Traffic Volume (vph)	14	766	46	0	584	0	0	449	0	0	348	137
Future Volume (vph)	14	766	46	0	584	0	0	449	0	0	348	137
Ideal Flow (vphpl)	1900	1900	1900	1900	1900	1900	1900	1900	1900	1900	1900	1900
Lane Width	12	11	11	12	12	12	12	10	12	12	10	12
Total Lost time (s)		5.0			5.0			5.0			5.0	
Lane Util. Factor		0.95			0.95			1.00			0.95	
Frt		0.99			1.00			1.00			0.96	
Flt Protected		1.00			1.00			1.00			1.00	
Satd. Flow (prot)		3024			3505			1689			2743	
Flt Permitted		0.94			1.00			1.00			1.00	
Satd. Flow (perm)		2842			3505			1689			2743	
Peak-hour factor, PHF	0.93	0.93	0.93	0.93	0.93	0.93	0.93	0.93	0.93	0.93	0.93	0.93
Adj. Flow (vph)	15	824	49	0	628	0	0	483	0	0	374	147
RTOR Reduction (vph)	0	3	0	0	0	0	0	0	0	0	35	0
Lane Group Flow (vph)	0	885	0	0	628	0	0	483	0	0	486	0
Heavy Vehicles (%)	100%	3%	30%	2%	3%	2%	2%	5%	2%	2%	8%	14%
Bus Blockages (#/hr)	0	5	5	0	0	0	0	0	0	0	4	6
Parking (#/hr)		5	5								4	6
Turn Type		NA			NA			NA			NA	
Protected Phases		2!			6!			4!			8!	
Permitted Phases												
Actuated Green, G (s)		51.0			51.0			59.0			59.0	
Effective Green, g (s)		51.0			51.0			59.0			59.0	
Actuated g/C Ratio		0.42			0.42			0.49			0.49	
Clearance Time (s)		5.0			5.0			5.0			5.0	
Lane Grp Cap (vph)		1207			1489			830			1348	
v/s Ratio Prot					0.18			c0.29			0.18	
v/s Ratio Perm		c0.31										
v/c Ratio		8.17dl			0.42			0.58			0.36	
Uniform Delay, d1		28.8			24.2			21.7			18.8	
Progression Factor		1.00			1.00			0.08			0.43	
Incremental Delay, d2		4.0			0.9			2.4			0.7	
Delay (s)		32.8			25.0			4.3			8.8	
Level of Service		C			C			A			A	
Approach Delay (s)		32.8			25.0			4.3			8.8	
Approach LOS		C			C			A			A	

Intersection Summary

HCM 2000 Control Delay	20.4	HCM 2000 Level of Service	C
HCM 2000 Volume to Capacity ratio	0.65		
Actuated Cycle Length (s)	120.0	Sum of lost time (s)	10.0
Intersection Capacity Utilization	64.6%	ICU Level of Service	C
Analysis Period (min)	15		

dl Defacto Left Lane. Recode with 1 though lane as a left lane.

dr Defacto Right Lane. Recode with 1 though lane as a right lane.

! Phase conflict between lane groups.

c Critical Lane Group

HCM Signalized Intersection Capacity Analysis
8: Westchester Avenue

2029 Build
PM Peak Hour



Movement	WBL	WBR	NET	NER	SWL	SWT
Lane Configurations			↑	↗		↑↑
Traffic Volume (vph)	0	0	449	241	0	394
Future Volume (vph)	0	0	449	241	0	394
Ideal Flow (vphpl)	1900	1900	1900	1900	1900	1900
Lane Width	12	12	10	10	12	10
Total Lost time (s)			5.0	5.0		2.0
Lane Util. Factor			1.00	1.00		0.95
Frt			1.00	0.85		1.00
Flt Protected			1.00	1.00		1.00
Satd. Flow (prot)			1689	1315		3303
Flt Permitted			1.00	1.00		1.00
Satd. Flow (perm)			1689	1315		3303
Peak-hour factor, PHF	0.93	0.93	0.93	0.93	0.93	0.93
Adj. Flow (vph)	0	0	483	259	0	424
RTOR Reduction (vph)	0	0	0	132	0	0
Lane Group Flow (vph)	0	0	483	127	0	424
Heavy Vehicles (%)	2%	2%	5%	2%	2%	2%
Parking (#/hr)				2		
Turn Type			NA	Perm		NA
Protected Phases			4			9
Permitted Phases				4		
Actuated Green, G (s)			59.0	59.0		120.0
Effective Green, g (s)			59.0	59.0		120.0
Actuated g/C Ratio			0.49	0.49		1.00
Clearance Time (s)			5.0	5.0		2.0
Lane Grp Cap (vph)			830	646		3303
v/s Ratio Prot			c0.29			c0.13
v/s Ratio Perm				0.10		
v/c Ratio			0.58	0.20		0.13
Uniform Delay, d1			21.7	17.2		0.0
Progression Factor			1.00	1.00		1.00
Incremental Delay, d2			3.0	0.7		0.1
Delay (s)			24.7	17.9		0.1
Level of Service			C	B		A
Approach Delay (s)	0.0		22.3			0.1
Approach LOS	A		C			A
Intersection Summary						
HCM 2000 Control Delay			14.2		HCM 2000 Level of Service	B
HCM 2000 Volume to Capacity ratio			0.38			
Actuated Cycle Length (s)			120.0		Sum of lost time (s)	10.0
Intersection Capacity Utilization			27.8%		ICU Level of Service	A
Analysis Period (min)			15			

c Critical Lane Group

HCM Unsignalized Intersection Capacity Analysis

5: E Tremont & Blondell Avenue

2029 Build
PM Peak Hour

















Movement	EBL	EBT	WBT	WBR	SBL	SBR
Lane Configurations		↕↕	↕↕			
Traffic Volume (veh/h)	133	874	584	235	0	0
Future Volume (Veh/h)	133	874	584	235	0	0
Sign Control		Free	Free		Stop	
Grade		0%	0%		0%	
Peak Hour Factor	0.92	0.92	0.92	0.92	0.92	0.92
Hourly flow rate (vph)	145	950	635	255	0	0
Pedestrians						
Lane Width (ft)						
Walking Speed (ft/s)						
Percent Blockage						
Right turn flare (veh)						
Median type		None	None			
Median storage (veh)						
Upstream signal (ft)		222				
pX, platoon unblocked					0.77	
vC, conflicting volume	890				1528	445
vC1, stage 1 conf vol						
vC2, stage 2 conf vol						
vCu, unblocked vol	890				1096	445
tC, single (s)	4.1				6.8	6.9
tC, 2 stage (s)						
tF (s)	2.2				3.5	3.3
p0 queue free %	81				100	100
cM capacity (veh/h)	757				130	561
Direction, Lane #	EB 1	EB 2	WB 1	WB 2		
Volume Total	462	633	423	467		
Volume Left	145	0	0	0		
Volume Right	0	0	0	255		
cSH	757	1700	1700	1700		
Volume to Capacity	0.19	0.37	0.25	0.27		
Queue Length 95th (ft)	18	0	0	0		
Control Delay (s)	5.2	0.0	0.0	0.0		
Lane LOS	A					
Approach Delay (s)	2.2		0.0			
Approach LOS						
Intersection Summary						
Average Delay			1.2			
Intersection Capacity Utilization			58.3%		ICU Level of Service	B
Analysis Period (min)			15			

HCM Unsignalized Intersection Capacity Analysis

3: Blondell Avenue & Ponton Avenue



















2029 Build
SAT Peak Hour

												
Movement	EBL	EBT	EBR	WBL	WBT	WBR	NBL	NBT	NBR	SBL	SBT	SBR
Lane Configurations												
Traffic Volume (veh/h)	103	0	0	0	0	30	0	239	31	0	0	0
Future Volume (Veh/h)	103	0	0	0	0	30	0	239	31	0	0	0
Sign Control		Stop			Stop			Free			Free	
Grade		0%			0%			0%			0%	
Peak Hour Factor	0.93	0.93	0.93	0.93	0.93	0.93	0.93	0.93	0.93	0.93	0.93	0.93
Hourly flow rate (vph)	111	0	0	0	0	32	0	257	33	0	0	0
Pedestrians												
Lane Width (ft)												
Walking Speed (ft/s)												
Percent Blockage												
Right turn flare (veh)												
Median type								None			None	
Median storage (veh)												
Upstream signal (ft)												
pX, platoon unblocked												
vC, conflicting volume	306	290	0	274	274	274	0			290		
vC1, stage 1 conf vol												
vC2, stage 2 conf vol												
vCu, unblocked vol	306	290	0	274	274	274	0			290		
tC, single (s)	7.1	6.5	6.2	7.1	6.5	6.2	4.1			4.1		
tC, 2 stage (s)												
tF (s)	3.5	4.0	3.3	3.5	4.0	3.3	2.2			2.2		
p0 queue free %	82	100	100	100	100	96	100			100		
cM capacity (veh/h)	618	620	1085	679	634	765	1623			1272		
Direction, Lane #	EB 1	WB 1	NB 1									
Volume Total	111	32	290									
Volume Left	111	0	0									
Volume Right	0	32	33									
cSH	618	765	1700									
Volume to Capacity	0.18	0.04	0.17									
Queue Length 95th (ft)	16	3	0									
Control Delay (s)	12.1	9.9	0.0									
Lane LOS	B	A										
Approach Delay (s)	12.1	9.9	0.0									
Approach LOS	B	A										
Intersection Summary												
Average Delay			3.8									
Intersection Capacity Utilization			33.5%			ICU Level of Service			A			
Analysis Period (min)			15									

HCM Signalized Intersection Capacity Analysis

2: Blondell Avenue & Westchester Avenue

2029 Build
SAT Peak Hour

												
Movement	NBL	NBT	NBR	SBL	SBT	SBR	NEL	NET	NER	SWL	SWT	SWR
Lane Configurations								 			 	
Traffic Volume (vph)	97	150	127	0	0	0	72	275	0	0	394	67
Future Volume (vph)	97	150	127	0	0	0	72	275	0	0	394	67
Ideal Flow (vphpl)	1900	1900	1900	1900	1900	1900	1900	1900	1900	1900	1900	1900
Lane Width	11	11	16	12	12	12	12	10	11	12	10	12
Total Lost time (s)	5.0	5.0	5.0					5.0			5.0	
Lane Util. Factor	1.00	1.00	1.00					0.95			0.95	
Frt	1.00	1.00	0.85					1.00			0.98	
Flt Protected	0.95	1.00	1.00					0.99			1.00	
Satd. Flow (prot)	1728	1801	1794					2992			3178	
Flt Permitted	0.95	1.00	1.00					0.77			1.00	
Satd. Flow (perm)	1728	1801	1794					2333			3178	
Peak-hour factor, PHF	0.95	0.95	0.95	0.95	0.95	0.95	0.95	0.95	0.95	0.95	0.95	0.95
Adj. Flow (vph)	102	158	134	0	0	0	76	289	0	0	415	71
RTOR Reduction (vph)	0	0	80	0	0	0	0	0	0	0	15	0
Lane Group Flow (vph)	102	158	54	0	0	0	0	365	0	0	471	0
Heavy Vehicles (%)	1%	2%	2%	2%	2%	2%	3%	6%	2%	2%	4%	2%
Bus Blockages (#/hr)	0	0	0	0	0	0	0	1	0	0	0	0
Parking (#/hr)								1				
Turn Type	Split	NA	Perm					NA			NA	
Protected Phases	6!	6!						4!			8	
Permitted Phases			6									
Actuated Green, G (s)	36.0	36.0	36.0					44.0			44.0	
Effective Green, g (s)	36.0	36.0	36.0					44.0			44.0	
Actuated g/C Ratio	0.40	0.40	0.40					0.49			0.49	
Clearance Time (s)	5.0	5.0	5.0					5.0			5.0	
Lane Grp Cap (vph)	691	720	717					1140			1553	
v/s Ratio Prot	0.06	c0.09									0.15	
v/s Ratio Perm			0.03					c0.16				
v/c Ratio	0.15	0.22	0.07					0.32			0.30	
Uniform Delay, d1	17.2	17.8	16.7					13.9			13.8	
Progression Factor	1.00	1.00	1.00					1.00			1.00	
Incremental Delay, d2	0.5	0.7	0.2					0.7			0.5	
Delay (s)	17.7	18.5	16.9					14.7			14.3	
Level of Service	B	B	B					B			B	
Approach Delay (s)		17.7			0.0			14.7			14.3	
Approach LOS		B			A			B			B	
Intersection Summary												
HCM 2000 Control Delay			15.5					HCM 2000 Level of Service			B	
HCM 2000 Volume to Capacity ratio			0.27									
Actuated Cycle Length (s)			90.0					Sum of lost time (s)		10.0		
Intersection Capacity Utilization			43.1%					ICU Level of Service		A		
Analysis Period (min)			15									
! Phase conflict between lane groups.												
c Critical Lane Group												

**AGENCY CORRESPONDENCE
APPENDIX**



June 16, 2017

Vincent Sapienza, P.E.
Acting Commissioner

Phillip Montgomery, P.E.
Technical Review Division
New York City Department of City Planning
120 Broadway, 31st Floor
New York, NY 10007-1216
212-720-3248
pmontgomery@planning.nyc.gov

Anastasios Georgelis, P.E.
Acting Deputy Commissioner
Bureau of Water and
Sewer Operations

Re: ULURP # 170353 MMX
The elimination, discontinuance, and closing of Fink Avenue between Blondell Avenue and Waters Avenue, and adjustment of grades necessitated thereby, including authorization for any acquisition or disposition of real property related thereto.
Community District 11
Borough of the Bronx

59-17 Junction Boulevard
Flushing, NY 11373

Dear Mr. Montgomery:

watersewerplanning@dep.nyc.gov

The following are the Department of Environmental Protection (DEP) requirements for the referenced ULURP application.

Sewer System:

An amendment to the city's existing, proposed, or pending drainage plan is required to reflect the change in the city map, the time frame for completion of such map is one year from the final de-mapping action. To ensure the completion of this work, the applicant shall post a performance bond in the amount of \$5,000 to cover the cost of the drainage plan amendment. Said bond must be furnished concurrently with the agreement to be executed by the City of New York. The applicant may request the release of said bond upon review and approval of the amended drainage plan by this agency.

DEP records show a double barrel 14'-0" x 8'-6" combined overflow sewer across the bed of Fink Avenue between Blondell Avenue and Waters Avenue under de-mapping. A 50' wide easement (sewer width plus minimum of 15' from the outside edge of the sewer on both sides) is required in the de-mapped street portion owned by the applicant.

For your reference, a copy of DEP easement restrictions is enclosed.

Water Mains:

There are no requirements for water mains.

If you have any questions, please contact Lillian Cheng, P.E. at (718) 595-5240 or Bhaskar Nookala, P.E. at (718)-595-7387.

Sincerely,

Bhaskar Nookala, P.E.
Section Chief, Drainage and
Modeling

C: Jannine McColgan, P.E., Director of Water and Sewer Planning
Sham Hemraj, P.E., Chief of Distribution Engineering
Guo Zhan Wu, P.E., Chief, Site Connection, Green Infrastructure &
Plan Review
Ketki Patel, P.E., Chief, Drainage Review
Lixin (Lillian) Cheng, P.E., Drainage and Modeling
Bushra Asfare, Review Engineer
Record # 38893
File; BA/ba

With copies to:

- 1). Emily Keyes
NYC Law Dept.
100 Church Street, Room 5-198
New York, NY 10007
(212) 788-0718 phone
(212) 788-0937 fax
ekeyes@law.nyc.gov
- 2). Michael Nacmias, Esq.
Eric Palatnick, P.C.
32 Broadway, Suite 114
New York, NY 10004
(212) 425-4343 phone
(212) 968-7129 fax
nacmiasm@gmail.com

EASEMENT RESTRICTIONS

- a) No permanent construction of any kind resulting in permanent structures shall be erected within, under or less than 20 feet over said easement area.
- b) Complete vehicular access at all times shall be available to all necessary parties including NYC DEP, its agents, employees, servants and contractors, public or private, to enter upon the easement area to construct, reconstruct, lay, relay, maintain, operate and inspect the drainage system within the easement area
- c) No materials or equipment of any kind shall be placed for storage within or over said easement area
- d) No trees or shrubs of any kind shall be planted within or over said easement area
- e) All existing or proposed manholes within said easement shall be brought flush to the finished surface grade and provided with a manhole cover in accordance with the standards of the NYC DEP
- f) any new footings to be constructed for any new structures shall be completely outside the easement area and shall be located at such elevations to prevent the possibility of any loading being transmitted from the footings to any drainage structures
- g) within the easement area the declarant will be permitted to grade, place pavement for use as a parking area and erect any nonpermanent improvements, but if access to the sewer is required for the purpose of constructing, maintaining , repairing or reconstructing of the drainage system within the easement area, the declarant, his (her) heirs, successors and assignees shall bear the cost of removing and replacing the pavement and nonpermanent improvements installed by the declarant