

East Side Coastal Resiliency Construction Update

CB3 Parks Committee Meeting

BRC Senior Services Center

30 Delancey Street

January 11, 2024



Mayor's Office of
Resiliency

Highlights

- Employment Resources
- Overview of Contracts
 - PA1 Construction Progress
 - What We've Heard
 - PA2 Construction Progress
 - PC Construction Progress
 - What We've Heard

Employment Resources

The NYC Department of Design and Construction is hosting a Construction Career and Resource Fair in partnership with the Queens Borough President's Office.

A great opportunity to job search, network, and connect with employers from all backgrounds.

Meet employers, unions, and organizations with active opportunities!

Bring multiple copies of your résumé.

Come prepared to meet with representatives from various trades.



Donovan Richards Jr.
QUEENS BOROUGH PRESIDENT



Queens Construction Career and Training Resource Fair

Open to the Public
Thursday, February 1, 2024
11 am – 4pm

Queens Borough Hall
Helen Marshall Atrium
120-55 Queens Blvd
Queens, NY 11424

Job Seeker



Scan for more information

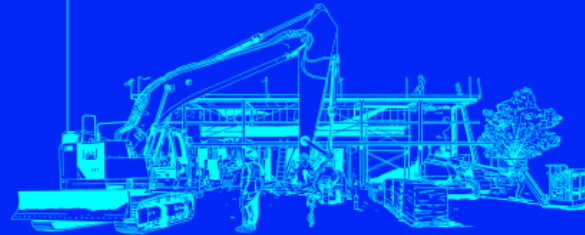

Overview of Contracts & Construction Updates

PROJECT AREA OVERVIEW

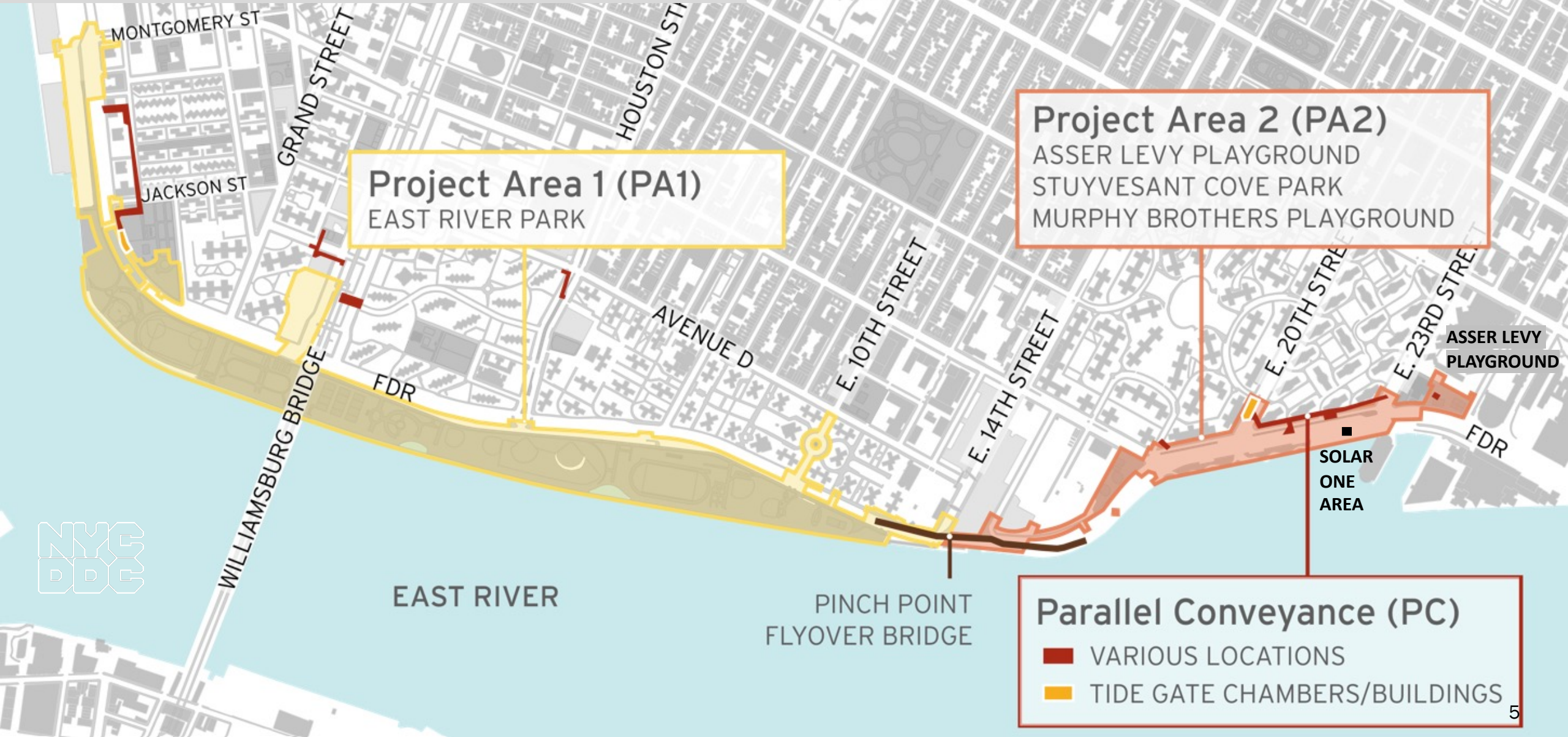

Project Area 1 (PA1)
EAST RIVER PARK

Project Area 2 (PA2)
ASSER LEVY PLAYGROUND
STUYVESANT COVE PARK
MURPHY BROTHERS PLAYGROUND

Parallel Conveyance (PC)
■ VARIOUS LOCATIONS
■ TIDE GATE CHAMBERS/BUILDINGS

Overview of Contracts

Project Area 1 (PA1)

NTP issued August 2021

- **Partial Closures:**
 - East River Park south of **E. Houston St.**
 - Greenway closure to E. 10th St.
 - Corlears Hook Park & passive lawn
- **Bridges:** Delancey St. & Corlears Hook pedestrian bridges under construction. Use Corlears Hook temp. ped bridge
- **Ongoing work:**
 - ongoing ConEd utility work
 - floodwall & esplanade construction activities ongoing as well as fill operation via barge
 - E. Houston St. retaining wall work
- **Amenities:**
 - Work begins at ballfields 3, 4 & 5
 - fields 1 & 2 construction in progress

Project Area 2 (PA2)

NTP issued November 2020

- **Asser Levy Playground Open**
 - gate 18 installed
- **Stuyvesant Cove Park Open**
 - **Entrances at E 20th St. and E 18th St.**
 - **Greenway connection to ERP opened**
 - gates 9-17 installed
- **Murphy Brothers** under construction
- over 2,700 ft of floodwall installed

Parallel Conveyance (PC)

NTP issued September 2022

- **Houston to Montgomery St. locations**
 - subsurface investigations in progress
 - water main replacement in progress
 - utility relocations
- **Avenue C (E. 18 - E. 23) locations**
 - subsurface investigations in progress

VISIT PA1 GALLERY:

<https://www.nyc.gov/site/escr/project-updates/pa1-gallery.page>

VISIT PA2 GALLERY:

<https://www.nyc.gov/site/escr/project-updates/pa2-gallery.page>

VISIT PC GALLERY:

<https://www.nyc.gov/site/escr/project-updates/pc-gallery.page>

Project Area 1

PA1 | 2024 Construction Activities

ALL WORK IS SUBJECT TO CHANGE

1. Esplanade removal and **reconstruction** activities along the waterfront. Deep sewer activities/pile install and park drainage work. Floodwall (Combi-wall) pre-drilling and installation. Fill material delivery by barge and placement onsite.
Ballfields 1 and 2 construction
2. Delancey Street - pile install and pier construction.
3. Construction for new Corlears Hook bridge.
4. Passive lawn partial closure for **esplanade work**.
February 2024 full closure for Delancey St. bridge staging.
5. Utility work around Montgomery Street & South Street.
Begin floodwall construction in 2024.

6. Montgomery St. – Cherry St. Greenway floodwall activities.
7. E. Houston Street pile install. Pedestrian Detour Shift.
8. Slip Ramps in use.
9. E 10th Street utility work and deep sewer work.
10. Ongoing partial FDR lane closures continue at various locations.

Weekly Bulletins & Advisories are issued with construction activities. Saturday work is anticipated for some work operations as indicated.



FOR ILLUSTRATIVE PURPOSES
SUBJECT TO MODIFICATIONS

PA1 | Building the new ESCR Esplanade

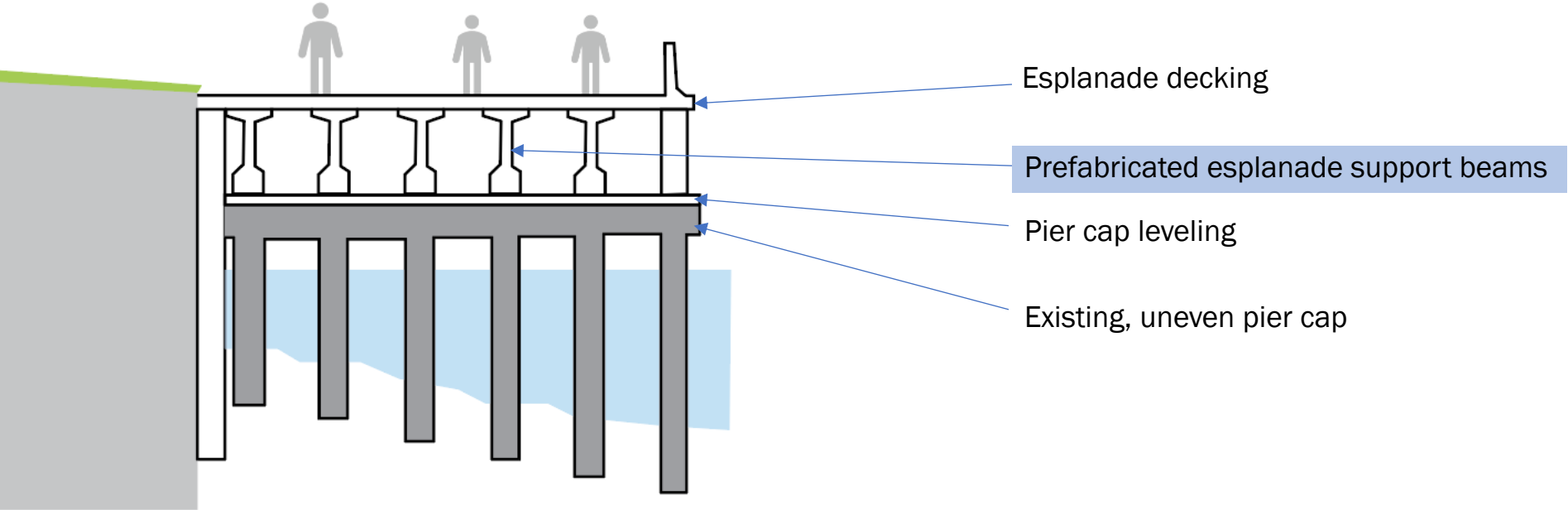

For illustrative purposes only

PA1 | Construction Photos

ALL WORK IS SUBJECT TO CHANGE



PA1 | Construction Photos

ALL WORK IS SUBJECT TO CHANGE



PA1 | Fields 1 and 2 - Rendering



Final PDC Presentation: <https://www.nyc.gov/assets/escr/downloads/pdf/DDC-f-ESCR-pres-rev-final-given-to-PDC-2020-01-30.pdf>

PA1 | Construction Photos

ALL WORK IS SUBJECT TO CHANGE

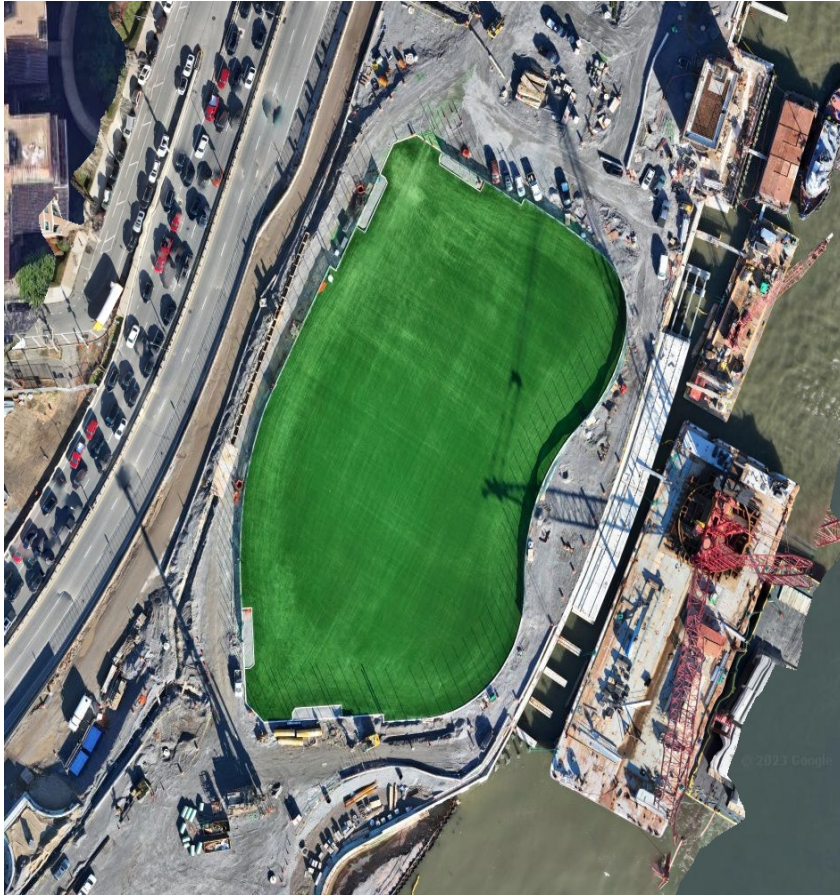

Birdseye of Ballfields 1 and 2 - January 2024

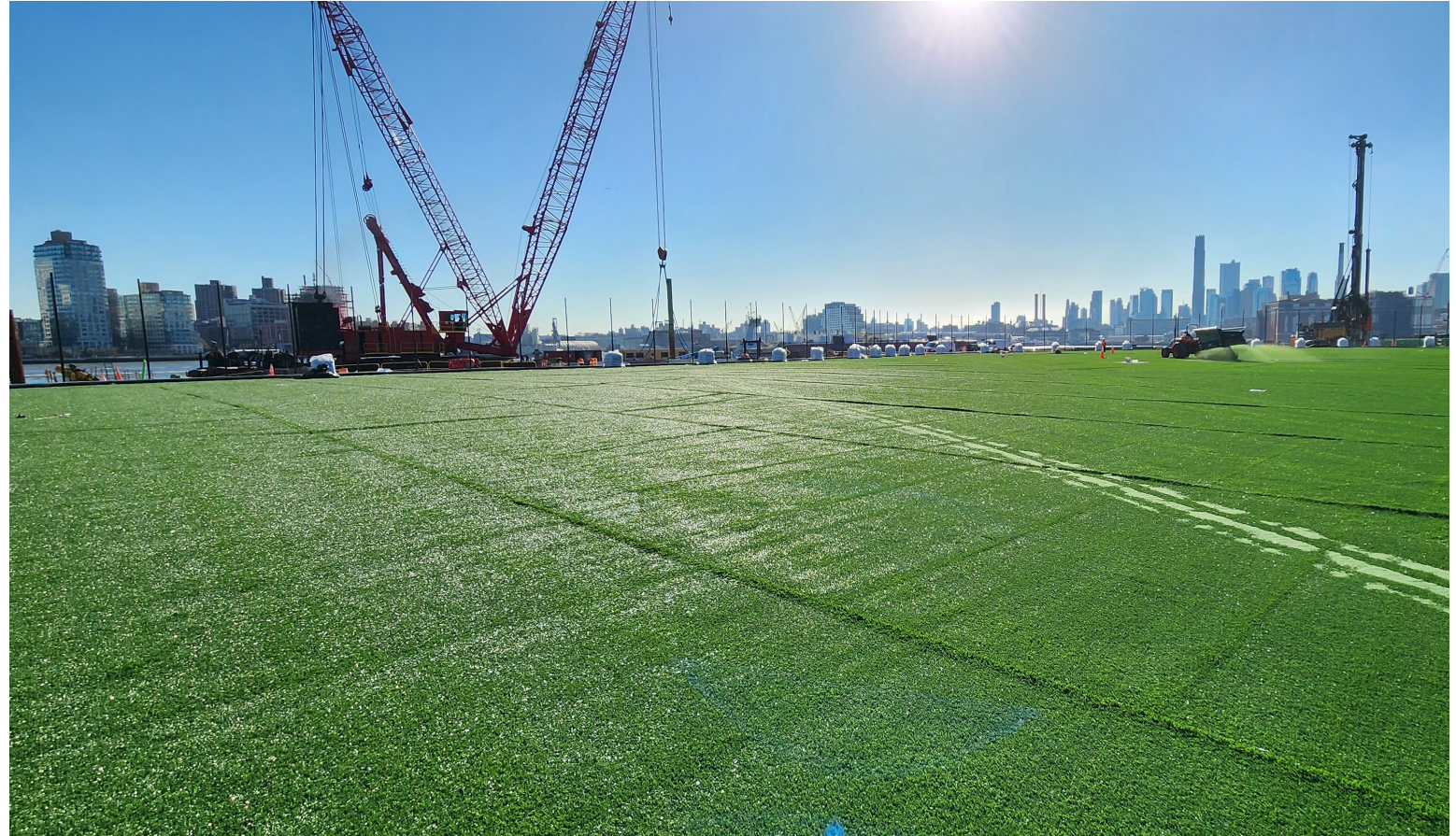

Ballfields 1 and 2 installation - December 2023

PA1 | What We've Heard

- **Fireboat House:** Parks and DDC are assessing the current condition of the building and scope for a potential rehab. Current building conditions show foundation settlement, multiple cracks in the foundation and cracks in floor slabs at both levels. In addition, as part of a separate contract, divers were enlisted to investigate the timber piles underneath the platform in front of the building which also support portions of the Fireboat House building. Timber piles accessible from the river were found to be rapidly deteriorating and a limited rehabilitation program is underway. However, rehabilitation of piles under the building is not possible with the building in place. The City has engaged the State Historic Preservation Office (SHPO) as part of the Section 106 process and will fund an alternatives analysis to determine next steps. Updates will be provided once the alternatives analysis is completed this spring. No final decision has been made.
- **Compost Yard:** The design concept was presented to LESEC in December 2023. Additional presentations will be made in advance of final design, which will go through PDC process. We will continue working with LESEC and come back to CB3 in the spring.
- **Phase One Openings:** Updates will be presented at the next Community Advisory Group (CAG) meeting.

Project Area 2

PA2 | Construction Progress

ALL WORK IS SUBJECT TO CHANGE

Stuyvesant Cove Park

- Park south of Solar One **OPEN!**
- E. 23rd Street entrance at Solar One building is closed for Solar One construction work. Greenway remains open.
- Greenway connecting to East River Park **OPEN!**

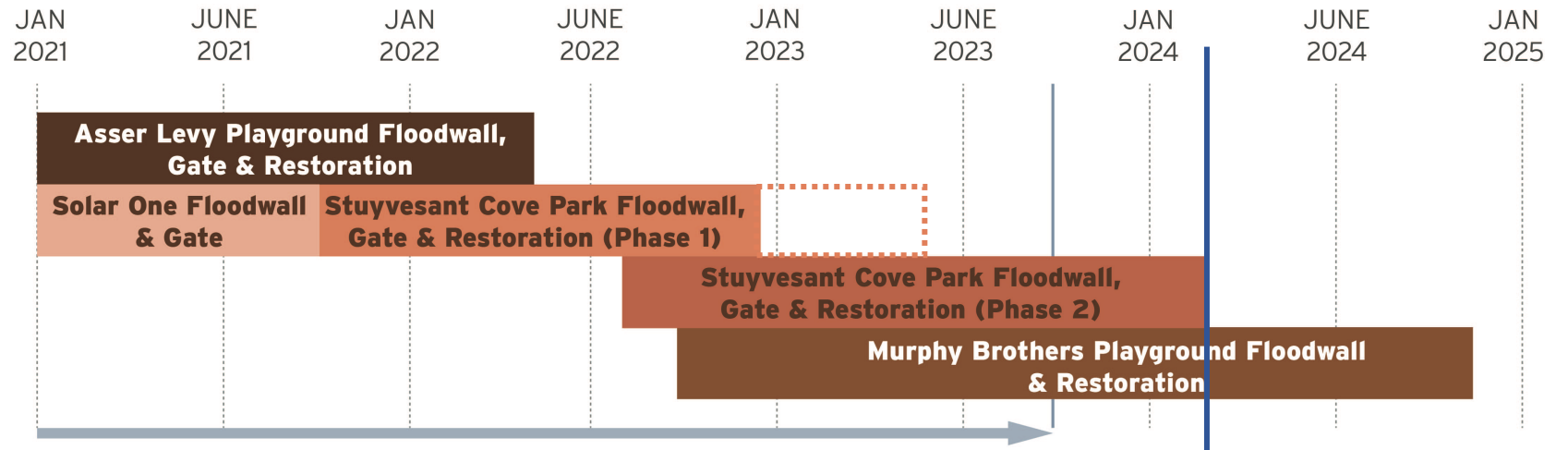

Completion of Flood Walls and Gates in Project Area 2

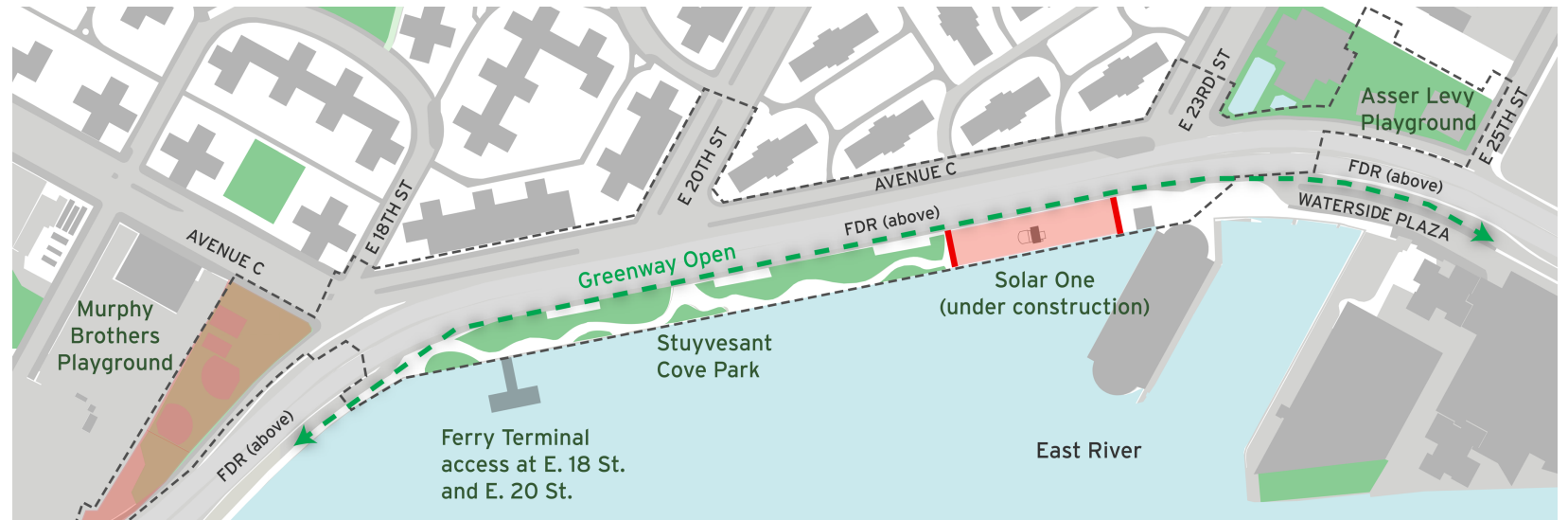

PA2 | Construction Photos

ALL WORK IS SUBJECT TO CHANGE



Stuyvesant Cove Park planting - December 2023



Greenway from East River Park Open - January 2024

Parallel Conveyance

PC | Construction Progress

ALL WORK IS SUBJECT TO CHANGE

- Location 1 – Jackson St. & Water St.
 - Utility relocation
- Location 2 – Lewis St. & Delancey St.
 - Utility relocation
- Location 3 – Baruch Dr. & Delancey St.
 - Utility relocation
 - Pinning
- Location 4 – Houston & Avenue D
 - Water main installation
 - Test pits
- Location 5 – Avenue C and E18th
 - No construction activities currently.
- Location 6 – Avenue C, E20rd to E25th
 - Test pits

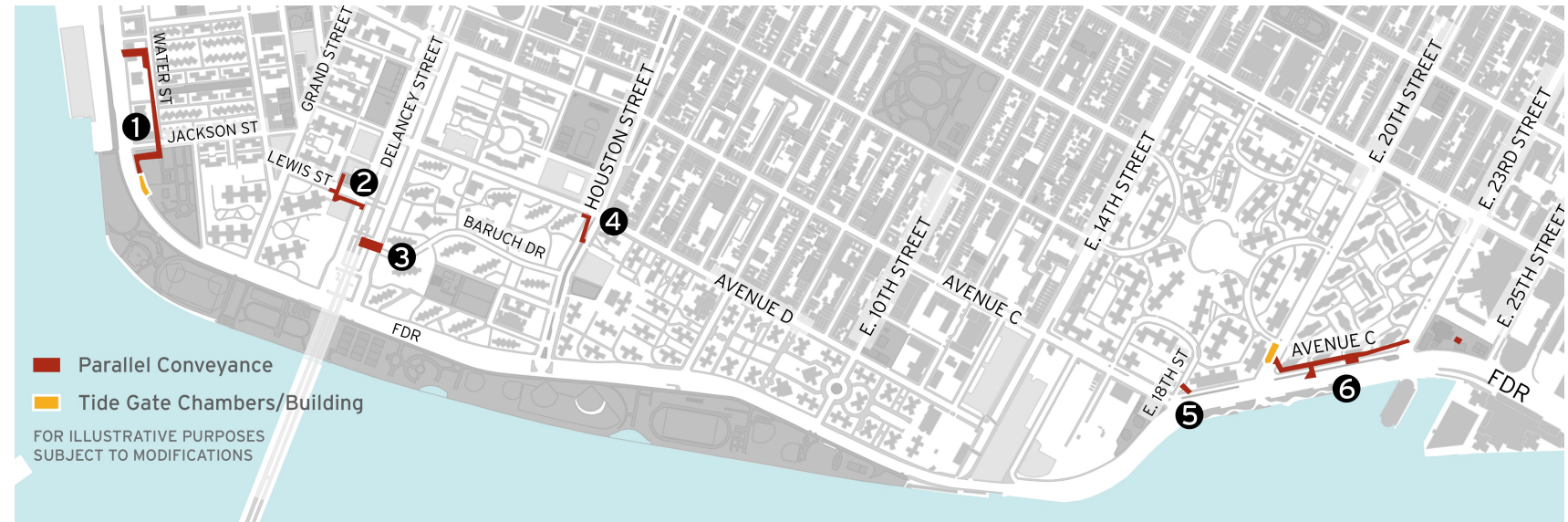

PC | What We've Heard

- **Corlears Hook Park Construction:** Start date is still being determined by Parks and DDC. Advisories will be distributed and posted on site prior to any mobilization.

NYC East Side Coastal Resiliency 311 Search all NYC.gov websites

NYC The East Side Coastal Resiliency Project 简体中文 Translate Text-Size

Home About Project Updates Community Engagement Contact Search

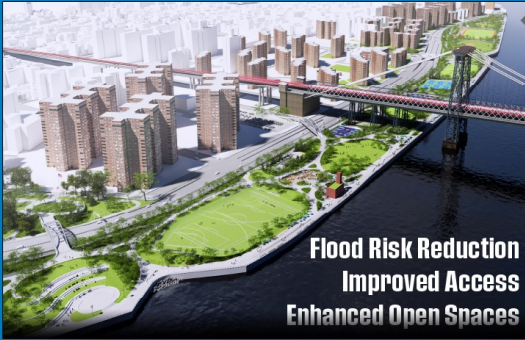





**Flood Risk Reduction
Improved Access
Enhanced Open Spaces**

LEARN MORE
Construction on the East Side Coastal Resiliency project will begin in Fall 2020. Learn more about where construction will occur and how to receive updates throughout the project.

East Side Coastal Resiliency

The East Side Coastal Resiliency (ESCR) Project is a coastal protection initiative, jointly funded by the City of New York and the federal government, aimed at reducing flood risk due to coastal storms and sea level rise on Manhattan's East Side from East 25th Street to Montgomery Street. The boundaries of this project correspond with the natural "pinch-points" in the 100-year floodplain: areas where the land is higher along the coastline, making it easier to close the system off from water entering from the north and south. The project design integrates flood protection into the community fabric, improving waterfront open spaces and access, rather than walling off the neighborhood. Construction on the East Side Coastal Resiliency project will begin in Fall 2020 and continue through 2025.

 <p>Construction Progress</p>	 <p>Resiliency & Flood Protection</p>	 <p>Project Background & Goals</p>	 <p>Project Design</p>
<p>Construction Notices View our most recent community presentations for updates as we prepare for upcoming construction activities.</p>	<p>Resiliency and Flood Protection Learn more about ESCR's resiliency and the forward-thinking flood protection measures being implemented to protect 110,000 New Yorkers from the impacts of climate change.</p>	<p>Project Background and Goals Read about the history and background of ESCR, and the goals driving this technically complex infrastructure project.</p>	<p>Project Design From flood protection measures to bike lanes and ball fields, the ESCR project is improving open spaces and access in the Lower East Side while strengthening the city's coastline.</p>

NEED MORE INFORMATION?

VISIT US AT:
www.nyc.gov/escr

